

Cub Cadet

Parts Manual

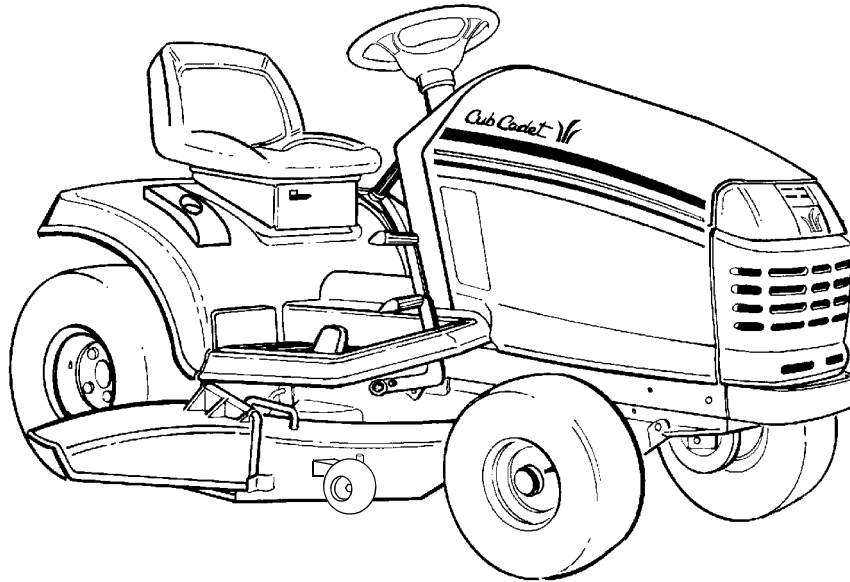

SERIES 2000

TRACTOR

Model Number

LT 2138

CUB CADET LLC P.O. BOX 361131 CLEVELAND, OHIO 44136-0019 [www.cubcadet.com]

PRINTED IN U.S.A.

FORM NO. 770-10283F
(11/03)

MODEL LT2138

TABLE OF CONTENTS

DESCRIPTION	PAGE	DESCRIPTION	PAGE
Axle, Front	40	Engine Mounting	20
Battery	16	Fender	32
Brakes	4	Frame	18
Bulkhead	15	Fuel Tank	19
Controls		Grille	30
Engine	15	Hood	30
Pedal	4	Hydraulic Filter	14
Transmission	8	Hydraulic Linkage	14
Dash Panel	15	Hydrostatic Pump, Model BDU-10L-225	12
Drawbar	18	Implement Lift Handle	34
Drive Line	9	Implement Lift Hanger	35
Electrical		Mower Deck.....	36
Switches	16	Muffler	20
Wiring	16	PTO Clutch	19
Engine		Running Board	32
Air Filter	25	Seat	3
Blower Housing	24	Side Panels	30
Breather	22	Steering	6
Carburetor	26	Transmission, Hydro	10
Controls	27	Wheels, Front & Rear	40
Crankcase	21		
Crankshaft	24		
Cylinder Head	22		
Electrical	29		
Exhaust.....	24		
Flywheel	29		
Fuel System	26		
Oil Pan	23		
Starter	28		
Valves	22		

NOTE: For **painted parts**, please refer to the list of color codes below. Please add the applicable color code, wherever needed, to the part number to order a replacement part.

For instance, if a part, numbered 700-xxxx, is painted Cub Yellow, the part number to order would be 700-xxxx-0716.

Cub Yellow: 0716
Cub Beige: 0499
Cub Blue: 0685
Powder Black: 0637

SEAT AND SUPPORT

REF. NO.	PART NUMBER	DESCRIPTION	QTY.
1	703-2394	Bracket, RH Seat Pivot	1
2	703-2395A	Seat, Base	1
	777I20310	Graphic, Seat Adjuster	1
3	703-2477	Bracket, LH Seat Pivot	1
4	703-2628	Bracket, Fender Reinforcement	2
5	710-0451	Bolt, Carriage, 5/16-18 x .75	6
6	710-3123	Screw, Hx Cap Lock, 3/8-16 x 1.25 GR5	4
7	712-04054	Nut, Hex Flange Lock, 5/16-18	8
8	720-0190	Knob, Seat Adjuster	1
9	731-3154	Slide, Seat	4
10	731-3162	Tray, Tool	1
11	732-3080A	Spring, Comp, 1.9 OD x 2.4	2
12	732-04100	Index Spring, Seat Adjuster	1
13	736-3052	Washer, Flat, .406 x 1.0 x .105	4
14	738-0140	Bolt, Shoulder	2
15	738-04013A	Spacer, Seat Slide Shoulder	4
16	757-04005	Seat, High Back	1
	777D06883	Graphic, Seat Back	1
	777D01782	Graphic, Made in USA	1

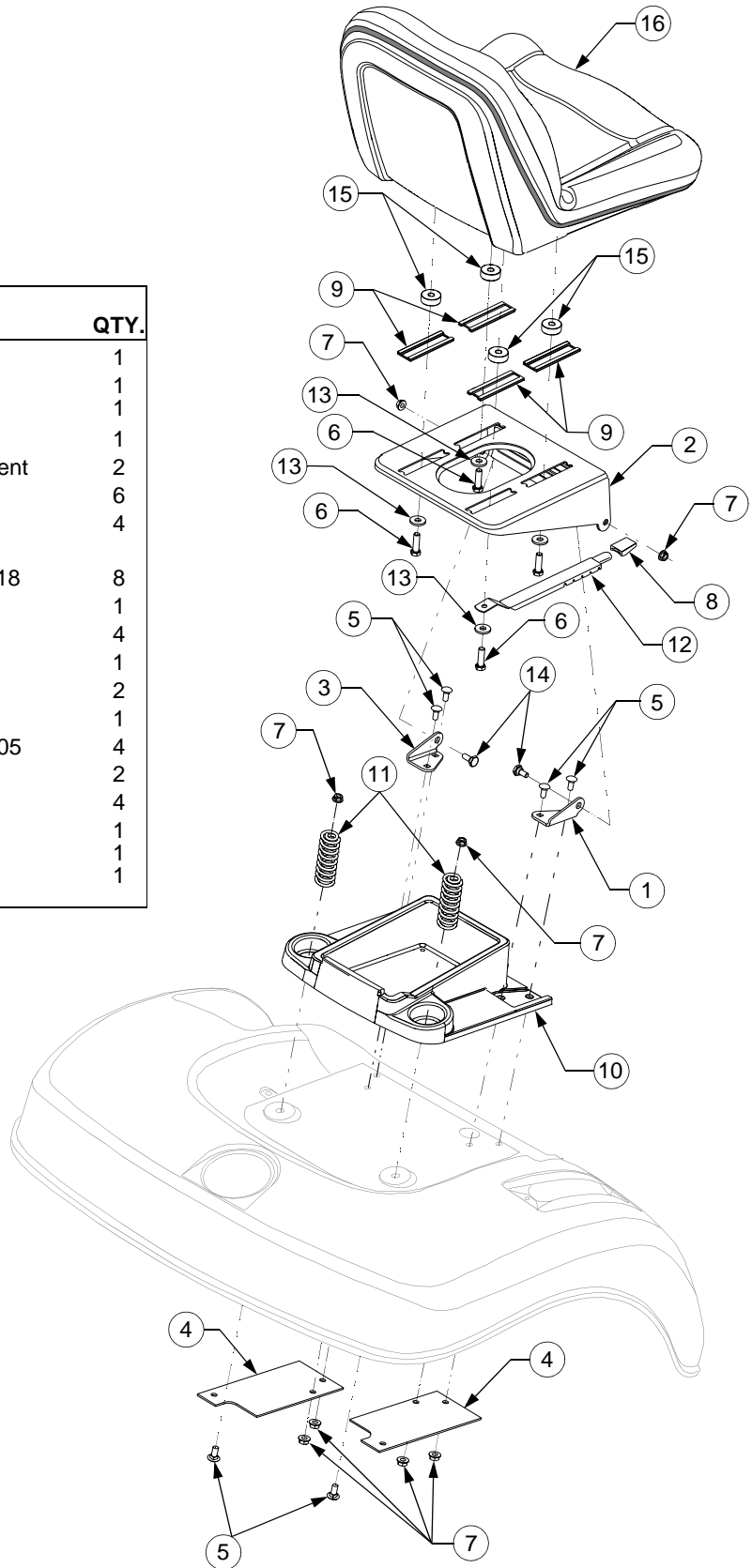

BRAKE AND CONTROL PEDALS

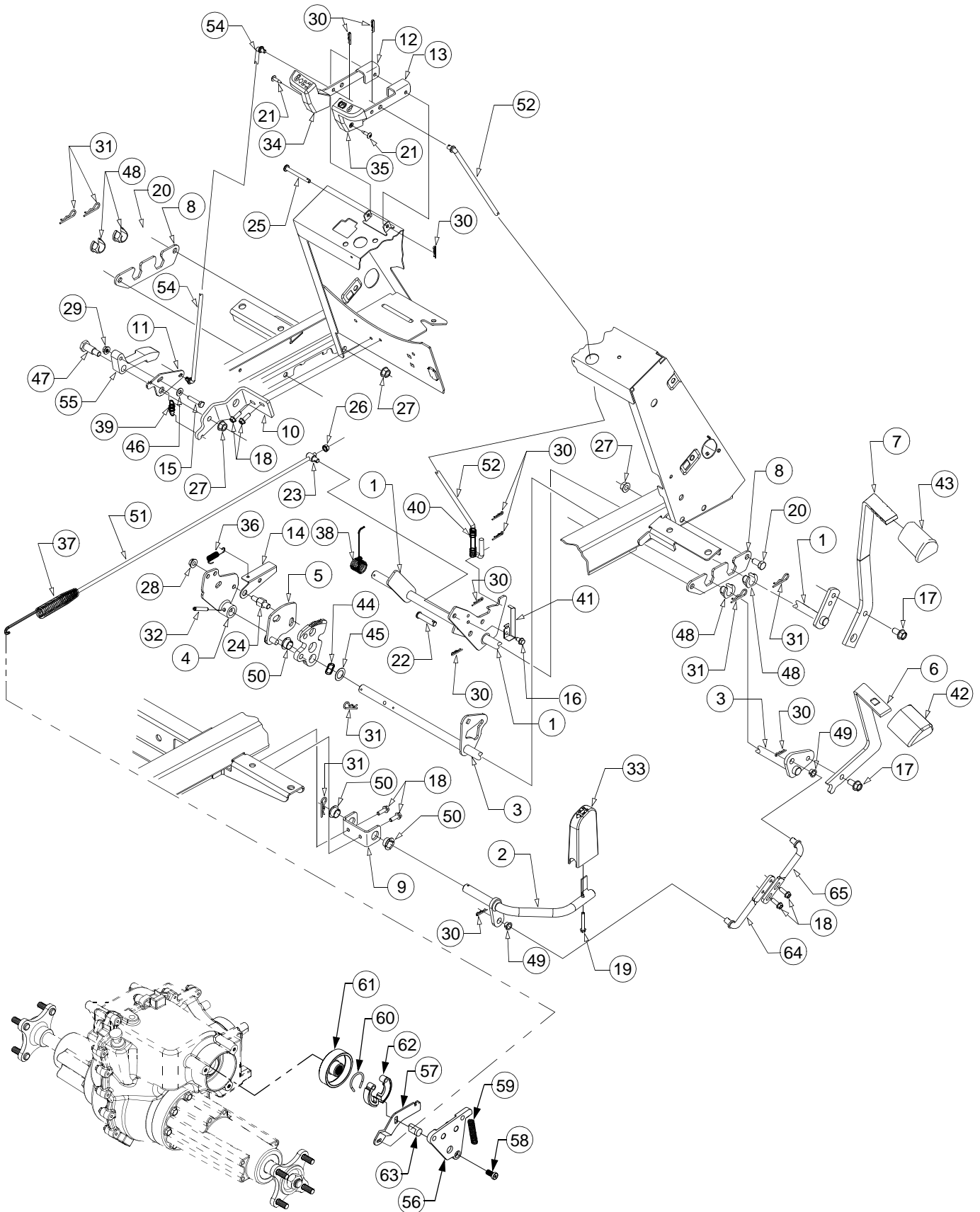

BRAKE AND CONTROL PEDALS

REF. NO.	PART NUMBER	DESCRIPTION	QTY.	REF. NO.	PART NUMBER	DESCRIPTION	QTY.
1	603-0321A	Shaft Assy, Brake	1	33	731-3205	Pedal, Reverse	1
2	603-0412	Pedal Assy, Reverse	1	34	731-3206	Knob, Cruise	1
3	603-0697	Shaft Assy, Forward/Reverse	1	35	731-3207	Knob, Brake Lock	1
4	603-0419	Cam Assy, Control	1	36	732-0418	Spring, Extension, .38 OD x 2.1	1
5	603-0421A	Plate Assy, Disengagement	1	37	732-0463A	Spring, Extension	1
6	703-2570A	Pedal, Forward	1	38	732-0756A	Spring, Torsion	1
7	703-2573A	Pedal, Brake	1	39	732-04006	Spring, Extension, .6 OD x 1.34	1
8	703-2804	Plate, Bearing Mounting	2	40	732-3099	Spring, Compression, .50 x 2.23	1
9	703-2938	Bracket, Reverse Pivot	1	41	732-3117	Spring, Switch Actuator	1
10	703-2941	Bracket, Cruise	1	42	735-3048	Pad, Forward Foot Control	1
11	703-2942	Plate, Rod Adjustment	1	43	735-3049	Pad, Brake Foot	1
12	703-2962	Lever, Cruise	1	44	736-0174	Washer, Wave, .625 x .885 x .015	1
13	703-2963	Lever, Brake Lock	1	45	736-0349	Washer, Flat, .635 x 1.0 x .020	1
14	703-2965	Actuator, Reverse Switch	1	46	736-0463	Washer, Flat, 1/4 x .63 x .051	1
15	710-0106	Screw, Hex Cap, 1/4-20 x 1.25	1	47	738-0145	Shoulder Bolt, .50 OD x .840	1
16	710-0599	Screw, Hex Wash Hd Tapp 1/4-20 x .5	1	48	741-3065B	Bearing, Hex Flange Split	4
17	710-0623	Screw, Hex Wash Hd Tapp 3/8-16x .75	2	49	741-3073	Bearing, Flange, .375 x .58 x .25	2
18	710-0642	Screw, Hex Wash Hd Tapp 1/4-20x .75	6	50	741-3074	Bearing, Flange, .626 x .93 x .344	3
19	710-0796	Screw, Truss Mach, #12 x 1.5	1	51	747-3216	Rod, Brake	1
20	710-0216	Screw, Hex Cap, 3/8-16 x .75 GR5	2	52	747-3219	Rod, Parking Brake	1
21	710-3009	Screw, Phil Hd Pan, #10-24 x .75	2	54	747-3307	Rod, Cruise	1
22	711-0415	Pin, Clevis, 3/8 x 1.62	1	55	748-3060	Latch, Cruise	1
23	711-0736	Ferrule, Adjustment, 1/4-20 Thrd	1	56	618-3060	Plate, Brake	1
24	711-1138	Stud, Actuator	1	57	703-2191	Arm, Brake	1
25	711-3295	Pin, Clevis, .25 x 2.38	1	58	710-3262	Screw, Low Hd Cap, 3/8-16 x .75	1
26	712-0271	Nut, Hex Sems, 1/4-20	1	59	732-0152	Spring, Compression	1
27	712-0431	Nut, Hex Flange Lock, 3/8-16	3	60	732-3077	Spring, Brake	1
28	712-3004A	Nut, Hex Flange Lock, 5/16-18	1	61	761-3019	Drum, Brake	1
29	712-3027	Nut, Hex Flange Lock, 1/4-20	1	62	761-3020	Shoe, Brake	1
30	714-0104	Pin, Internal Cotter, 5/16 Dia x 1.12	9	63	761-3028	Actuator, Brake Shoe	1
31	714-0145	Pin, Internal Cotter, 3/8 Dia x 1.62	6	64	747-3341A	Rod, Rear Connecting	1
32	715-0114	Pin, Spiral Spring, 1/4 x 1.5	1	65	747-3383	Rod, Front Connecting	1

STEERING

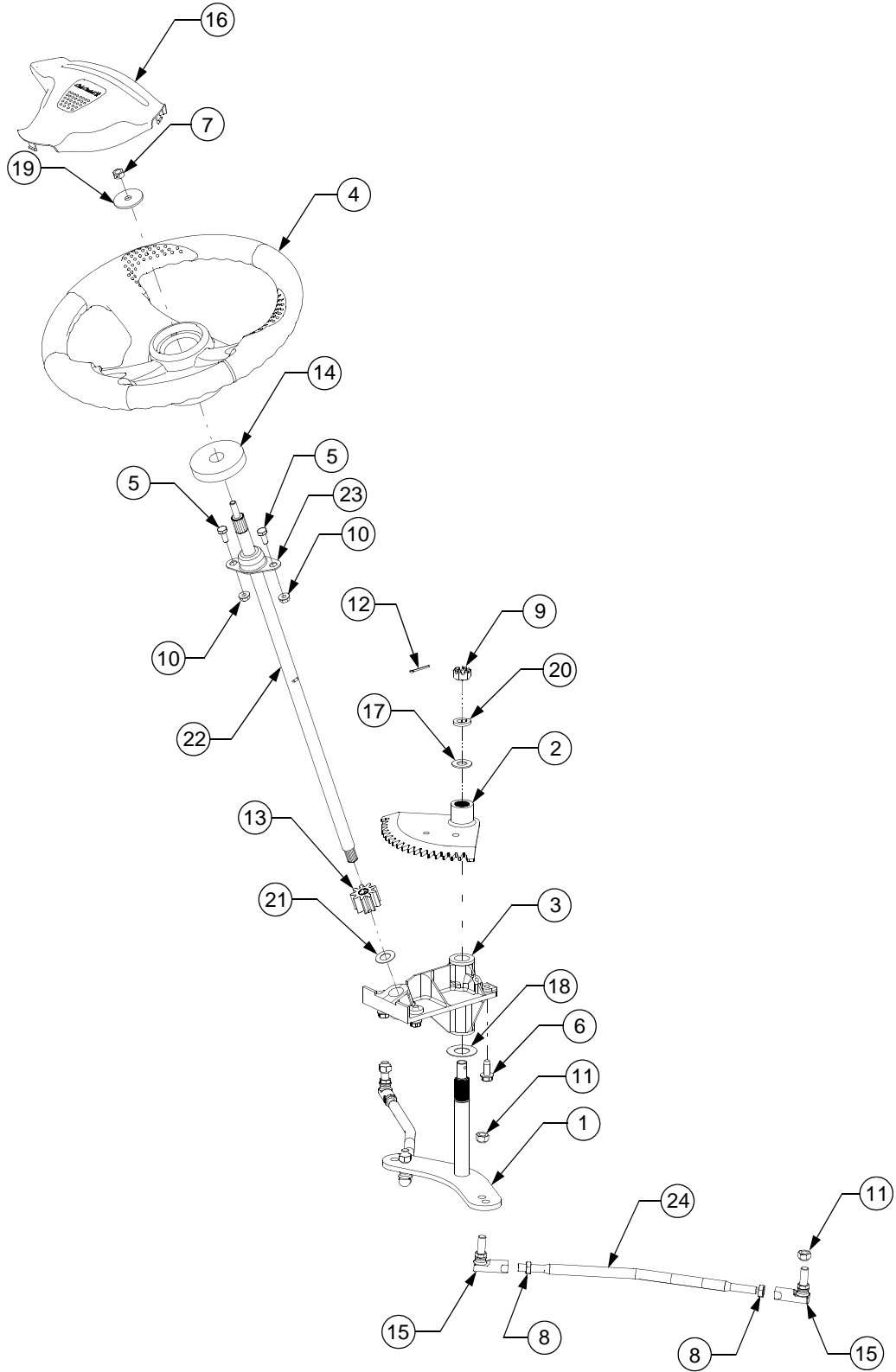

STEERING

REF. NO.	PART NUMBER	DESCRIPTION	QTY.
1	603-0064	Arm Assy, Lower Steering	1
2	603-0250	Segment Assy, 18T Steering	1
3	619-04079	Housing Assy,	1
	737-3000	Fitting, Grease, 3/16 Drive Type	1
	748-0108	Bearing, Flange, .503 ID	1
	748-3007A	Bearing, Bronze Flange, .75 ID	2
4	631-04008	Wheel, Steering, Soft Grip	1
5	710-0751	Screw, Hex Cap, 1/4 - 20 x .62, GR5	2
6	710-1260A	Screw, Hex Wash. Hd. Tapp 5/16 - 18 x .75	4
7	712-0237	Nut, Hex Center Lock, 5/16-18	1
8	712-0711	Nut, Hex Jam, 3/8-24 GR2	4
9	712-3012	Nut, Hex Slotted, 1/2-20 GR5	1
10	712-3027	Nut, Hex Flange Lock, 1/4-20	2
11	712-3054	Nut, Hex Lock, 3/8-24 GR5	4
12	714-3004	Pin, Cotter, 3/32 Dia x 1.25	1
13	717-04086	Pinion, Steering	1
14	722-3019	Gasket, Steering	1
15	723-0156	Joint, Ball, 3/8-24	4
16	731-04532	Cover, Steering Wheel	1
17	736-0272	Washer, Flat, .510 x 1 x .06 Thk	1
18	736-0351	Washer, Flat, .760 x 1.5 x .03 Thk	1
19	736-04062	Washer, Flat, .344 x 1.5 x .1 Thk	1
20	736-0921	Washer, Lock, 1/2	1
21	736-3013	Washer, Flat, .531 x 1 x .027 Thk	1
22	738-04064	Shaft, Steering	1
23	741-3025	Bearing, Flange	1
25	747-3171	Rod, Tie	2

TRANSMISSION CONTROLS

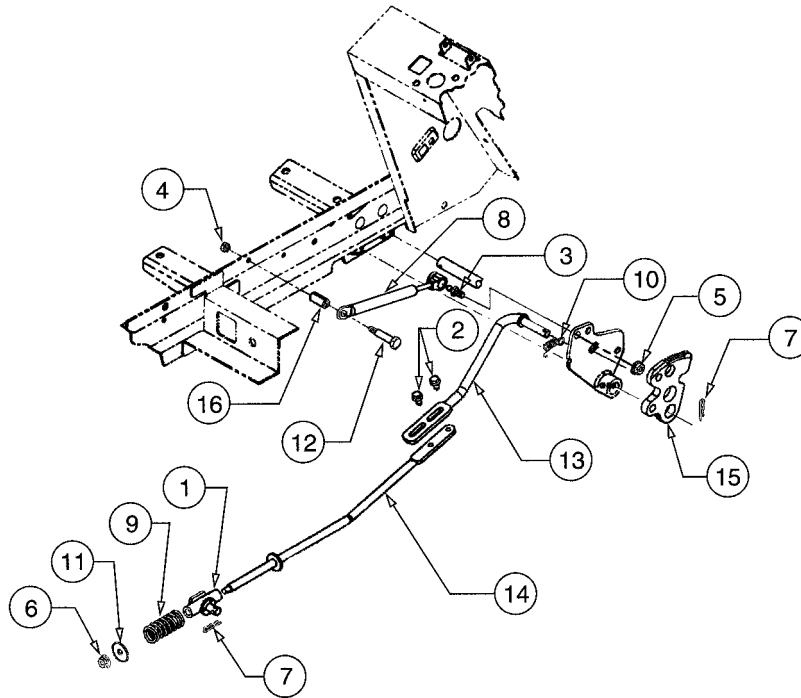

REF. NO.	PART NUMBER	DESCRIPTION	QTY.
1	603-0272	Pivot Assembly	1
2	710-0599	Screw, Hex Wsh Hd Tapp, 1/4-20 x .5	2
3	710-3170	Screw, Ball, 5/16-18 x.56	1
4	712-0271	Nut, Hex Sems, 1/4-20	1
5	712-3004A	Nut, Hex Flange Lock, 5/16-18 GR5	1
6	712-3027	Nut, Hex Flange Lock, 1/4-20	1
7	714-0104	Pin, Internal Cotter	2
8	727-3090	Cylinder, Damper	1
9	732-3094	Spring, Compression, .63 ID x 2	1
10	732-3118	Spring, Extension, 3/8 OD x 1.44	1
11	736-3092	Washer, Flat, .265 x 1 x .030	1
12	738-0560	Bolt, Shoulder, .374 Dia x 1.375	1
13	747-3304	Rod, Front Control	1
14	747-3309	Rod, Rear Hydro Control	1
15	748-3070	Plate, Cruise	1
16	750-0434	Spacer, Split Tubing, .375 ID x 1.04	1

DRIVE LINE

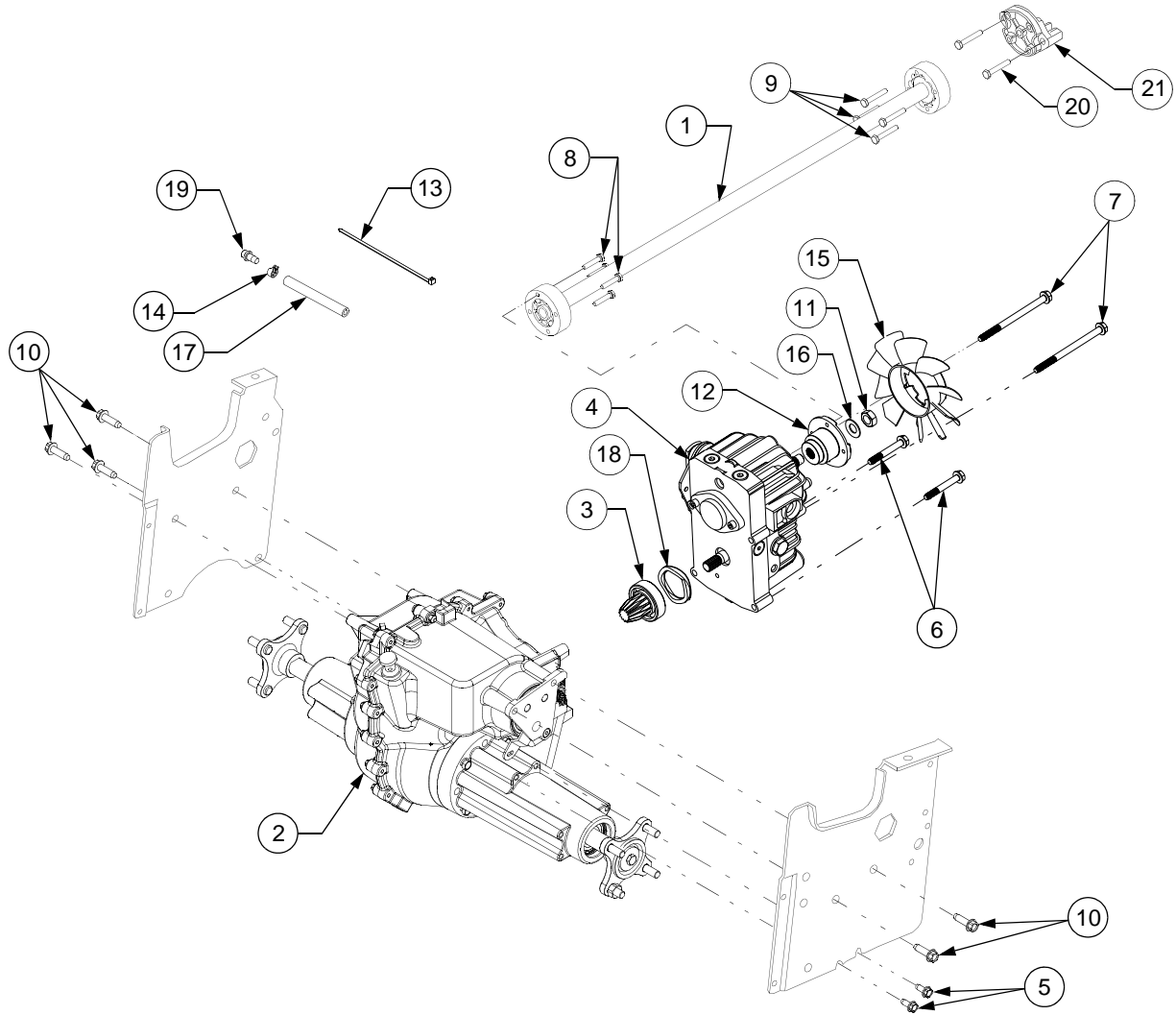

REF. NO.	PART NUMBER	DESCRIPTION	QTY.	REF. NO.	PART NUMBER	DESCRIPTION	QTY.
1	718-3147 759-3764	Shaft Assembly, Drive, 28.25 Lg Kit, Drive Barrel	1 2	10	710-3290	Screw, Hex Wsh Tap, 3/8-16 x 1.25	5
2	618-04110	Transmission Assembly, Does NOT include wheel hub as- semblies and brake spring	1	11	712-3059	Nut, Hex Top Lock Jam GR5, 1/2-20	1
3	618-3088	Pinion Assembly, Input	1	12	748-3093	Adapter, Pump	1
4	618-3243	Pump, Hydrostatic	1	13	725-0157	Tie, Self-Clinch Cable	1
5	710-1260A	Screw, Hex Wsh Tap, 5/16-18 x .75	2	14	726-0205	Clamp, Hose	1
6	710-3180	Screw, Hex Cap, 5/16-18 x 1.75 GR5	2	15	731-3297	Fan, 10 Blade Cooling	1
7	710-3195	Screw, Hex Cap, 5/16-18 x 4.5 GR5	2	16	736-0253	Washer, Bell, 1/2 ID	1
8	710-1062	Screw, Hex Patch, 1/4-20 x 1.25 GR5	4	17	759-3330	Line, Fuel, 7in (10ft Bulk)	1
9	710-3288	Screw, Hex Patch, 1/4-20 x 1.62 GR5	4	18	736-3099	Washer, Wave, 1.96 x 2.44 x .06	1
				19	737-0296	Vent	1
				20	KH-24-086-16	Screw, Hex Patch, M10-1.50x 90mm	2
				21	719-3096	Adapter, Drive Shaft	1

HYDRO TRANSMISSION

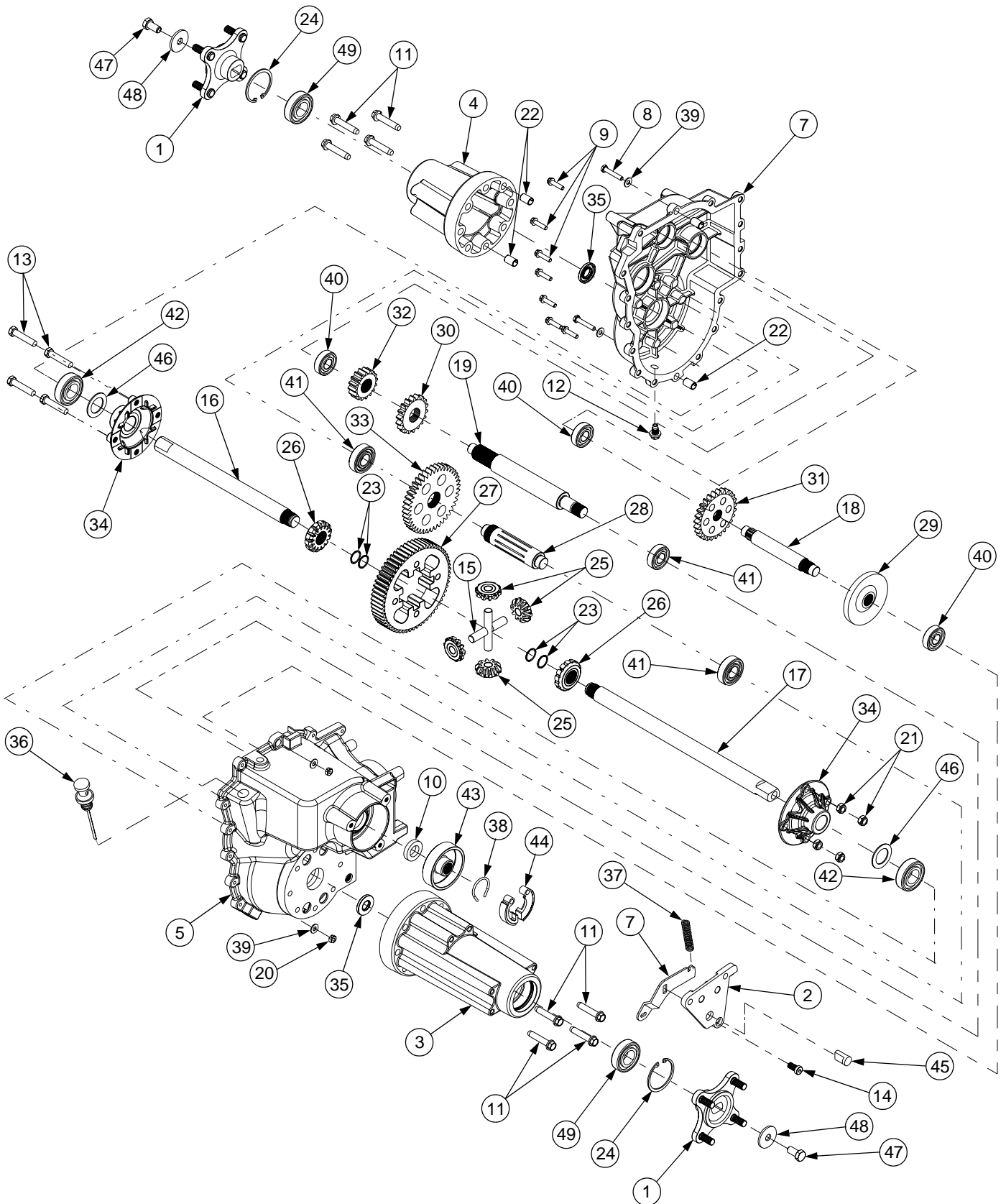

HYDRO TRANSMISSION

REF. NO.	PART NUMBER	DESCRIPTION	QTY.	REF. NO.	PART NUMBER	DESCRIPTION	QTY.
1	618-04115	Hub Assembly, Wheel	2	25	717-1446	Gear, Miter, 10T	4
2	618-3060	Plate Assembly, Brake	1	26	717-04102	Gear, Miter, 14T	2
3	619-0056	Axle Housing, RH	1	27	717-1568	Gear, Differential Spur, 60T	1
4	619-0057	Axle Housing, LH	1	28	717-3346	Shaft, Output, 9T	1
5	719-04078 759-3746	Transmission Housing, RH Sealant, Ultra Grey	1	29	717-3347	Gear, Bevel, 36T	1
6	719-04077	Transmission Housing, LH	1	30	717-04111	Gear, Spur, 18T	1
7	703-2191	Brake Arm	1	31	717-3388	Gear, Spur, 27T	1
8	710-0606	Screw, Hex Cap, 1/4-20 x 1.5	2	32	717-3391	Gear, Spur, 16T	1
9	710-0788	Screw, Hex Wash Hd Tap, 1/4-20 x 1.0	13	33	717-3392	Gear, Spur, 42T	1
10	721-3029	Seal, Shift Shaft	1	34	719-0375A	Housing, Differential, RH	2
11	710-1008	Screw, TT, 3/8-16 x 1.875	8	35	721-04031	Seal, Oil, 1.0 x 1.499	2
12	710-1633	Screw, Plug, M14 x 1.5 x .827	1	36	727-3085	Dipsick, Oil	1
13	710-3144	Screw, Hex Cap, 3/8-16 x 2.0 GR5	4	37	732-0152	Spring, Compression	1
14	710-3262	Screw, Cap, 3/8-16 x .750	1	38	732-3077	Spring, Brake Shoe	1
15	711-1052A	Shaft, Cross, .500 x 3.005	2	39	736-0463	Washer, Flat, .25 x .630 x .0515	4
16	711-04164	Shaft, Axle, 1.00 x 12.07	1	40	741-0361	Bearing, Ball, 17 ID x 40 OD x 12	3
17	711-04211	Shaft, Axle, 1.00 x 15.73	1	41	741-3057	Bearing, Ball, 6204	3
18	711-04210	Shaft, Drive	1	42	741-3114	Bearing, Ball, 6205-1	2
19	711-04209	Shaft, Intermediate	1	43	761-3019	Drum, Brake	1
20	712-0291	Nut, Hex Center Lock, 1/4-20	2	44	761-3020	Brake, Shoe	2
21	712-3020	Nut, Hex Insert Lock, 3/8-16 GR5	4	45	761-3028	Brake, Actuator	1
22	715-3045	Dowel Bushing	6	46	736-0745	Washer, Flat, 1.010 x .56 x .060	2
23	716-04032	Ring, Retaining, .938	4	47	710-3119	Screw, Hex Lock, 3/8-16 x .75 GR5	2
24	716-0204	Ring, Retaining,	2	48	736-0227	Washer, Flat, .39 x 1.5 x 1.34	2
				49	741-0681	Bearing, Ball	2

HYDROSTATIC PUMP

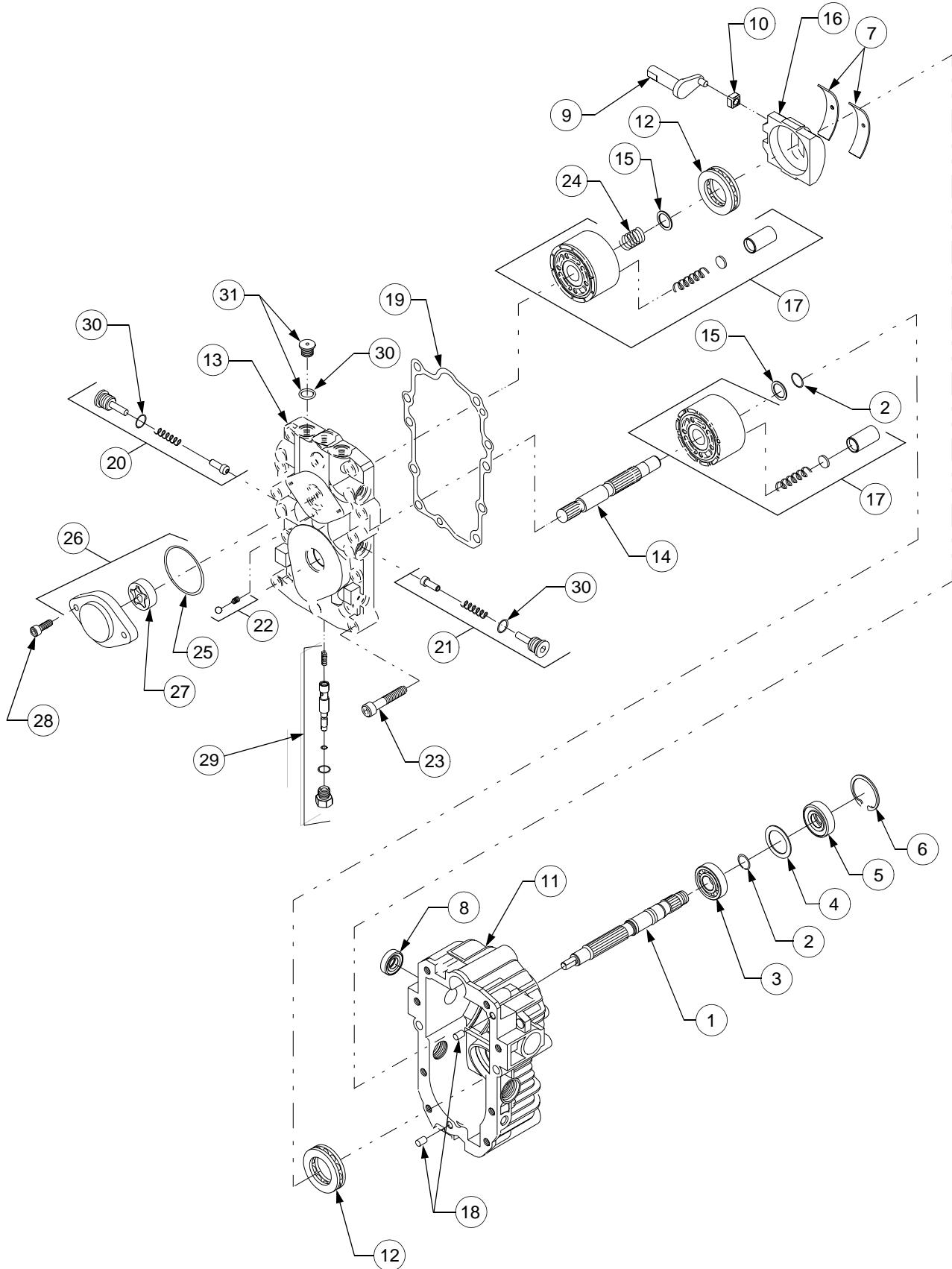

HYDROSTATIC PUMP

REF. NO.	PART NUMBER	DESCRIPTION	QTY.
1	HG-50158	Shaft, Pump (Splined)	1
2	HG-2003016	Ring, Retaining	2
3	HG-2003043	Bearing, Ball	1
4	HG-2003018	Spacer	1
5	HG-9008000-0128	Seal, Lip	1
6	HG-2003052	Ring, Retaining	1
7	HG-2003023	Bearing, Cradle	2
8	HG-9008000-0126	Seal, Lip	1
9	HG-2003005	Arm, Trunnion	1
10	HG-2000015	Guide, Slot	1
11	HG-2513036	Housing Kit	1
12	HG-2003044	Bearing Assembly, Thrust Ball	2
13	HG-51077	Center Section Kit	1
14	HG-2003034	Shaft, Motor	1
15	HG-2003017	Washer, Block Thrust	2
16	HG-2003087	Swash Plate	1
17	HG-70079	Block Assembly	2
18	HG-9004800-2506	Pin	2
19	HG-2003060	Gasket, Center Section	1
20	HG-2510027	Kit, Check Valve	1
21	HG-2510034	Kit, Orificed Check Valve	1
22	HG-2510011	Kit, Charge Relief Valve	1
23	HG-9007314-0808	Screw, Socket Hd	8
24	HG-2003014	Spring, Block	1
25	HG-9004101-1340	O-Ring	1
26	HG-2513027	Kit, Charge Pump	1
27	HG-J1041008	Gerotor Assy	1
28	HG-50095	Screw, Socket Hd	2
29	HG-2153011	Bypass Valve Kit	1
30	HG-9004201-3700	O-Ring	3
31	HG-9005110-5600	Plug w/O-Ring	2

NEUTRAL LINKAGE, HYDRAULIC PICKUP AND RETURN TUBES

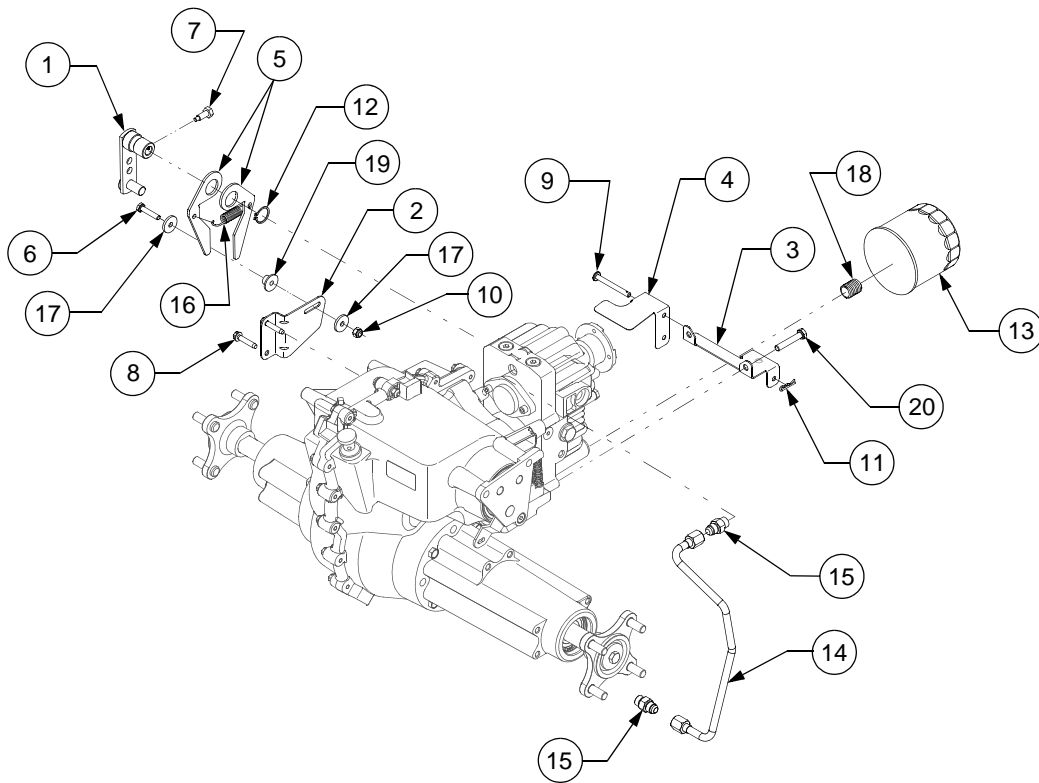

REF. NO.	PART NUMBER	DESCRIPTION	QTY.
1	603-0160	Arm Assembly, Control	1
2	603-04184	Bracket, Hydro Neutral	1
3	703-05315	Bracket, Hydro Dump Mtg,	1
4	730-05316	Bracket, Hydro Dump Actuator	1
5	703-2441	Arm, Neutral	2
6	710-0106	Screw, Hex Cap, 1/4-20 x 1.25	1
7	710-04171	Screw, Special Hex Cap, 5/16-24 x .625	1
8	710-0809	Screw, Hex Wash TT-Tap, 1/4-20 x 1.25	2
9	711-04220	Pin, Clevis, .25 x 2.38	1
10	712-0324	Nut, Hex Top Lock, 1/4-20	1
11	714-0104	Pin, Internal Cotter	1
12	716-0111	Ring, Snap, .875 Shaft	1
13	723-3014	Filter, Oil	1
14	727-04064	Tube, Hydro Inlet	1
15	727-3002	Connector, w/O-Ring	2
	721-3001	O-Ring, 3/8 OD Tube	2
16	732-3119	Spring, Extension, .5 OD x 1.97	1
17	736-0176	Washer, Flat, .25 x .93 x .120 Thk	2
18	737-3022	Nipple, Oil Filter	1
19	750-0918	Spacer, Centering	1
20	710-3180	Screw, Hex Cap, 5/16-18 x 1.75 GR5	2

BULKHEAD, DASH PANEL AND ENGINE CONTROLS

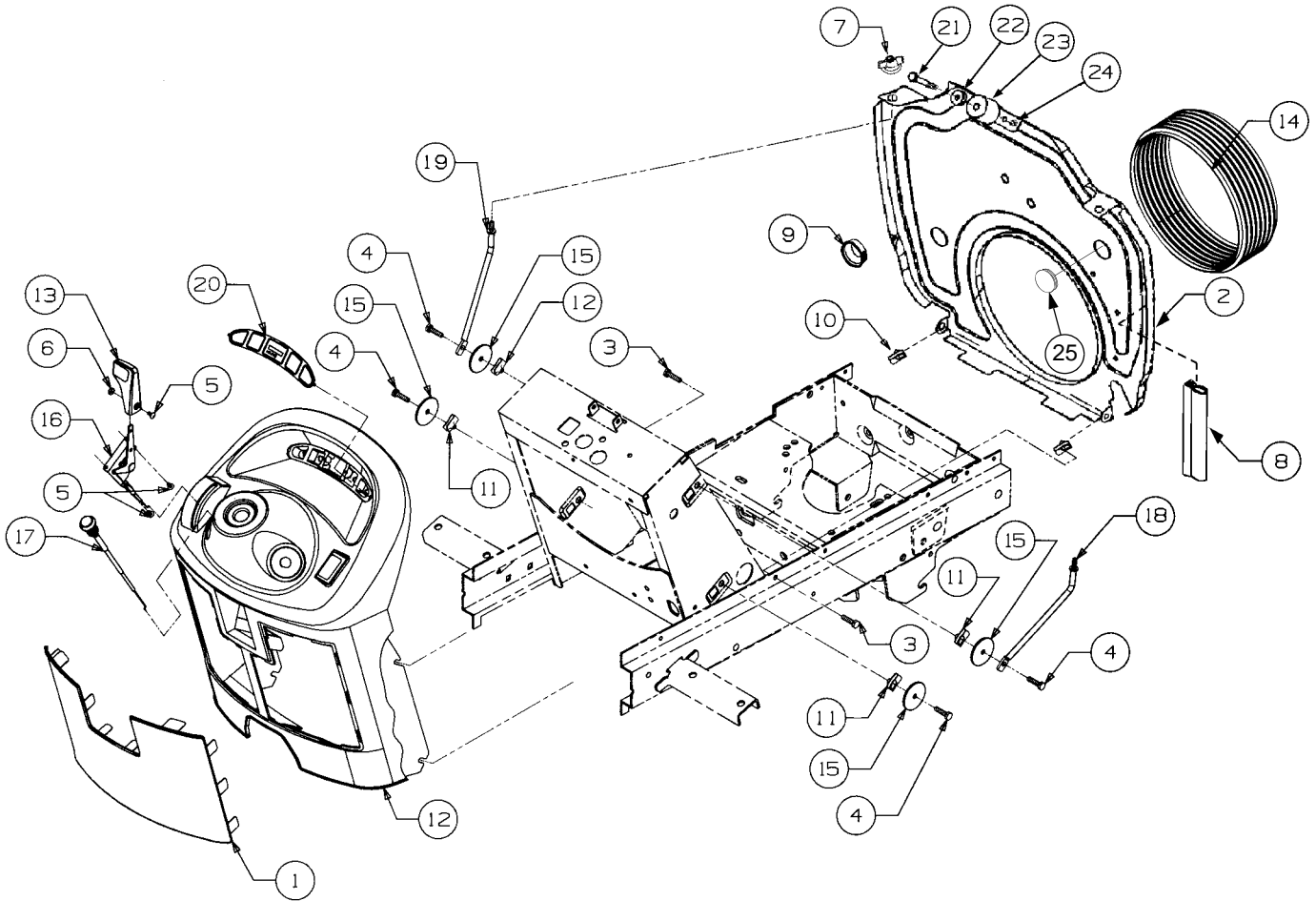

REF. NO.	PART NUMBER	DESCRIPTION	QTY.	REF. NO.	PART NUMBER	DESCRIPTION	QTY.
1	703-2557	Screen, Intake Dash	1	13	731-3161	Knob, Throttle	1
2	703-3108B	Bulkhead, Lower	1	14	731-3317A	Boot, Intake	1
3	710-0751	Screw, Hex Cap, 1/4-20 x .625	2	15	736-3128	Washer, Flat, .285 x 1.75 x .10	4
4	710-0597	Screw, Hex Cap, 1/4-20 x 1.0	4	16	746-3035	Control, Throttle	1
5	710-3217	Screw, Cross Rec Trus, #8-32 x .38	3	17	746-3051	Control, Choke	1
6	712-0142	Nut, #8-32	1	18	747-3226	Rod, RH Mounting	1
7	712-0397	Nut, Wing w/Bell Washer 1/4-20	2	19	747-3227	Rod, LH Mounting	1
8	720-3024-36	Seal, Push On Trim	28in	20	777I20312	Label, Dash	1
9	723-3042	Bushing, Snap, 7/8 ID	1	21	710-0136	Screw, Hex Cap, 1/4-20 x 1.75 GR5	1
10	726-3048	Nut, U-Type Speed, 1/4-20	2	22	736-0342	Washer, Flat, .283 x .75 x .030	1
11	726-3054	Nut, U-Clip, 1/4-20	4	23	731-3232	Roller, Hood Latch	1
12	731-3137A	Panel, Dash	1	24	712-0271	Nut, Hex Sems, 1/4-20	1
	777I20306	Graphic, Ignition Switch	1	25	720-3025	Plug, Button	1

BATTERY, ELECTRICAL COMPONENTS AND SWITCHES

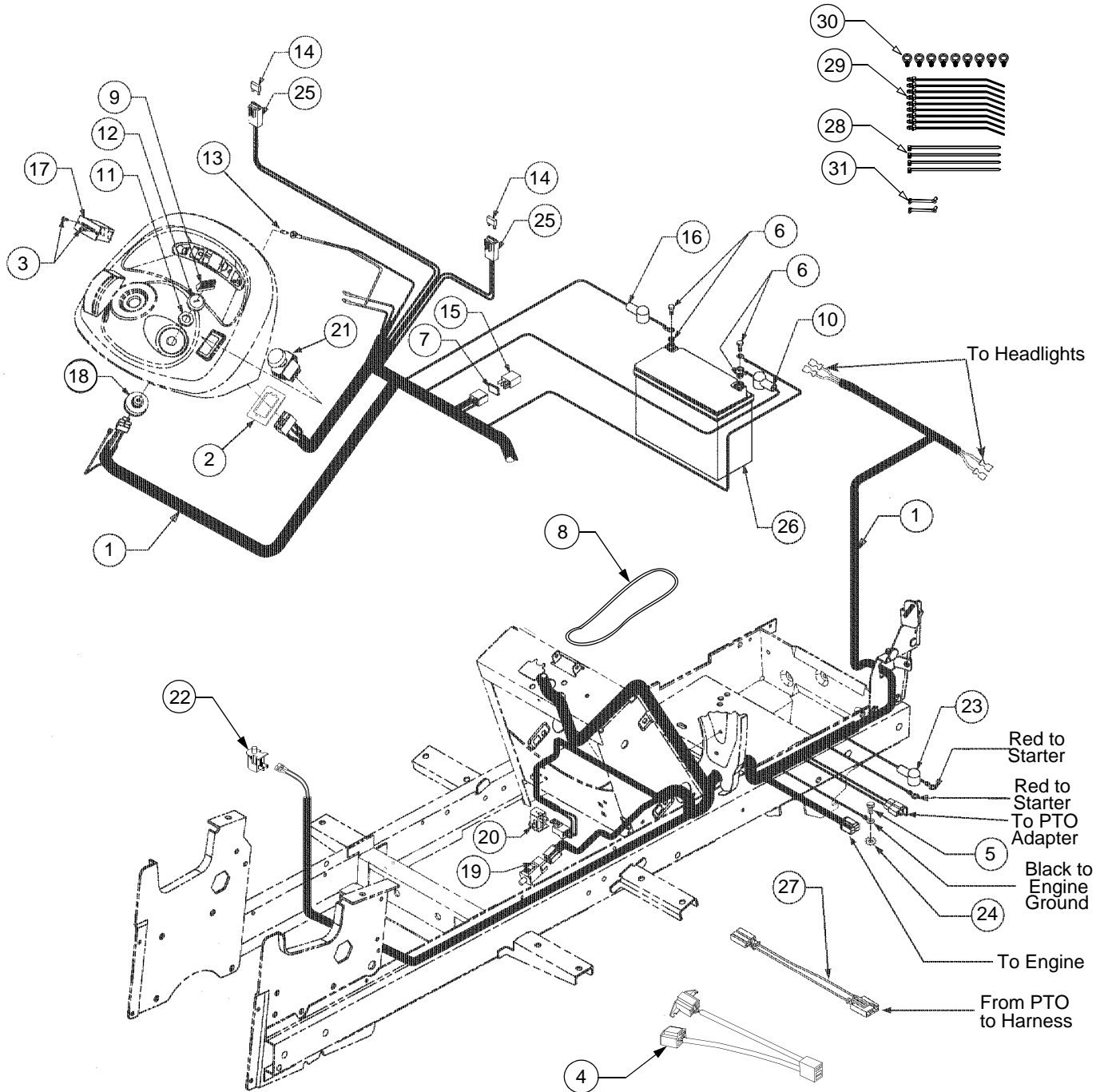

BATTERY, ELECTRICAL COMPONENTS AND SWITCHES

REF. NO.	PART NUMBER	DESCRIPTION	QTY.
1	629-3068A	Wire Harness, Main	1
2	783-0462	Bracket, PTO Switch Retainer	1
3	710-0936	Screw, Truss Hd Tapp, #6 x .62	AR
4	629-3072A	Wire Harness, S.A.M.	1
5	710-0237	Screw, Hex Cap, 5.16-24 x .625 GR5	1
6		Battery Cable Hardware	
	710-3015	Screw	2
	712-0271	Sems Nut	2
7	721-0342	Gasket, Silicone	1
8	723-04016	Strap, Battery Retainer	1
9	759-3476A	Key, Ignition (Set of 2)	1
10	725-0340	Cover, Terminal Black	1
11	725-1346	Nut, Ignition Switch	1
12	725-1347	Cap, Ignition Switch	1
13	725-1365	Bulb, Indicator	1
14	725-3243	Fuse, 25 Amp	2
15	725-1648	Relay	1
16	725-3007A	Cover, Terminal Red	1
17	725-3159	Hour Meter	1
18	725-3284	Switch, Ignition	1
19	725-3164A	Switch, Interlock (Brake)	1
20	725-3166	Switch, Snap Mount	1
21	725-3233	Switch, PTO	1
22	725-3166	Switch, Snap Mount Seat	1
23	725-3237	Cover, Terminal Red	1
24	736-0607	Washer, External Lock, 5/16	1
25	729-0357	Holder, Fuse w/Mounting Clip	2
26	925-1707D	Battery	1
27	725-3242	Adapter, PTO Harness	1
28	725-0157	Tie, Self-Clinch Cable	4
30	726-0154	Tie, Pushmount	9
31	726-3055	Clip, Cable	9
32	726-0161	Clip, Wire	2

FRAME AND DRAWBAR

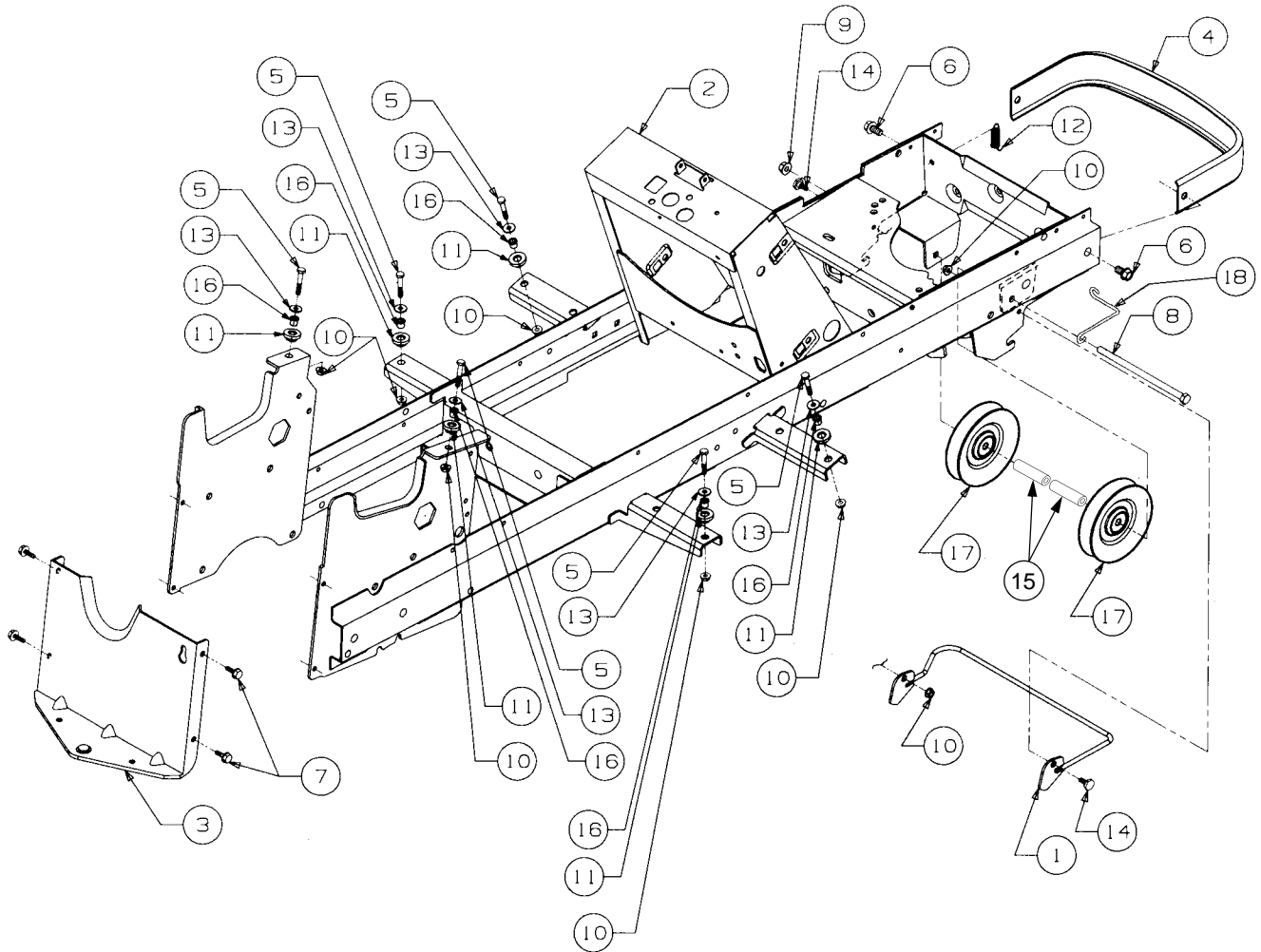

REF. NO.	PART NUMBER	DESCRIPTION	QTY.
1	603-0132	Rod, Quick Attach	1
2	603-0328C	Frame	1
3	703-2257	Drawbar	1
	777120296	Graphic, Transmission Release Lever	1
4	703-2577	Bumper	1
5	710-0597	Screw, Hex Cap, 1/4-20 x 1.0	6
6	710-0623	Screw, Hex Wsh Hd Tapp 3/8-16 x .75	2
7	710-1260A	Screw, Hex Wsh Hd Tap 5/16-18 x .75	4
8	710-3261	Screw, Hex Cap, 3/8-16 x 7.0	1
9	712-0431	Nut, Hex Flange Lock, 3/8-16	1
10	712-3027	Nut, Hex Flange Lock, 1/4-20	8
11	722-0258	Grommet, Insulator	6
12	732-3002	Spring, Latch	1
13	736-3090	Washer, Flat, .255 x .72 x .60	6
14	738-0255	Bolt, Shoulder	2
15	750-04198	Spacer, Idler, .411 x .720 x 3.67	2
16	750-3169	Spacer, .28 x .40 x .42 Lg	6
17	756-3045	Pulley, Idler	2
18	732-0970	Belt Guide	1

PTO CLUTCH

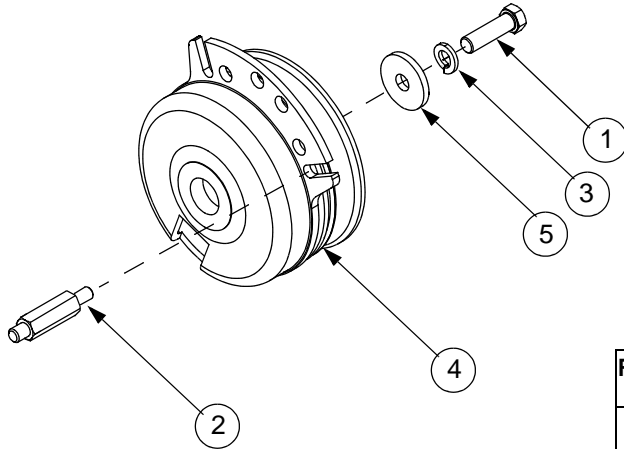

REF. NO.	PART NUMBER	DESCRIPTION	QTY.
1	710-0757	Screw, Hex Cap, 7/16-20 x 1.5 GR5	1
2	711-1099	Stud, Clutch Stop	1
3	736-0171	Washer, Lock, 3/8	1
4	717-3385A	Clutch Assy, PTO	1
	711-3351	Spacer (Not Shown)	1
5	736-3082A	Washer, Flat, .445 x 1.5 x 1.72 Hdn	1

FUEL TANK

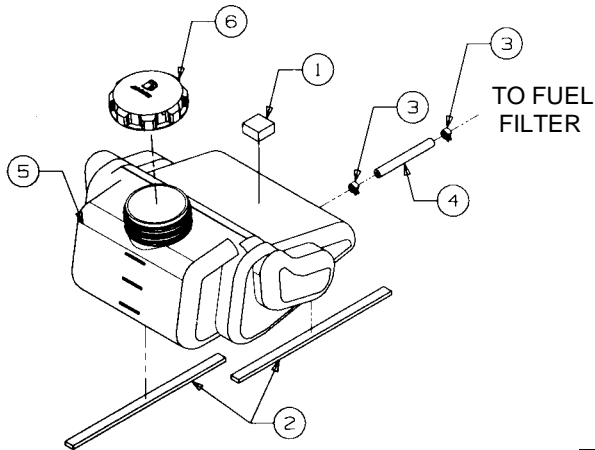

REF. NO.	PART NUMBER	DESCRIPTION	QTY.
1	722-3020	Foam, 1.25 Sq x .62 Thk	AR
2	722-3022	Tape, Foam, .625 Wide x .25 Thk	AR
3	726-0205	Clamp, Hose	2
4	759-3330	Line, Fuel, 72" (Shipped In 10ft Length)	1
5	751-3112B	Tank, Fuel	1
6	751-3124B	Cap, Fuel	1
†	723-3066-24	Insulator, Foam Fuel Line	1

† Not Shown

ENGINE MOUNTING AND MUFFLER

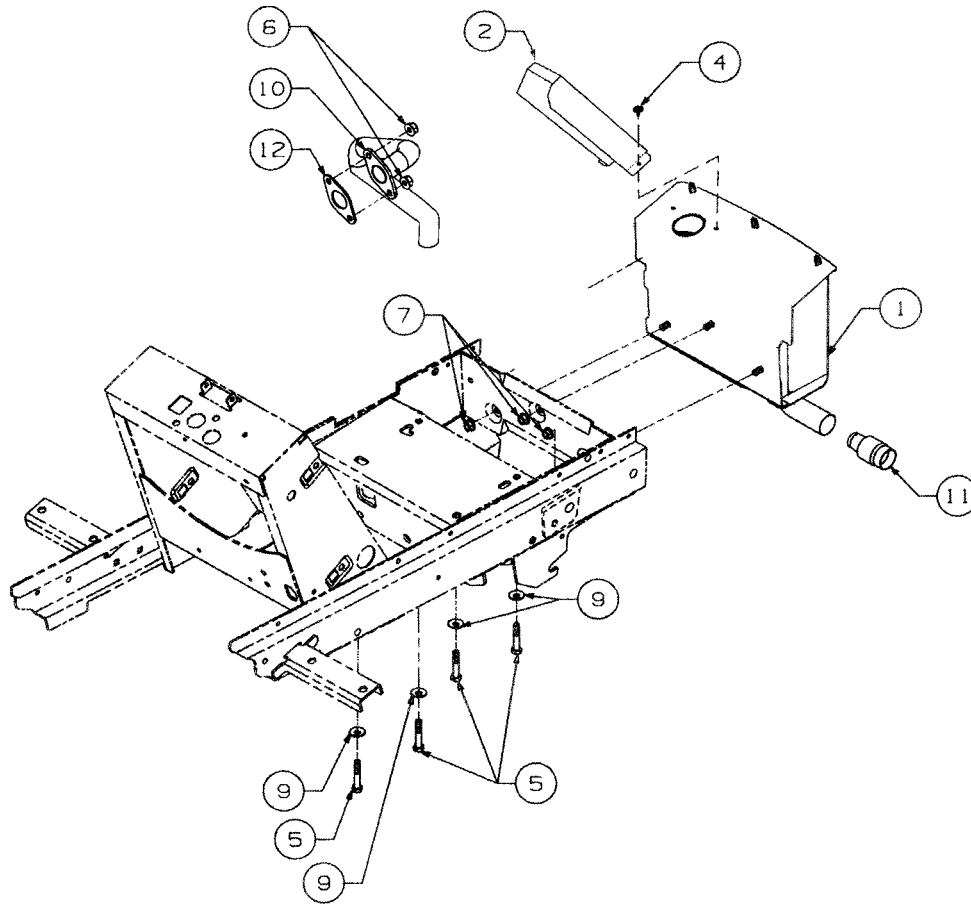

REF. NO.	PART NUMBER	DESCRIPTION	QTY.
1	651-3001	Muffler Assembly	1
2	703-3099	Shield, Muffler Tube	1
4	710-1268	Screw, Hex Wsh Hd Tap, #10-16 x .38	3
5	710-3290	Bolt, Eng Mount, 3/8-16 x 1.25	4
6	712-3086	Nut, Exhaust, M8 x 1.25	2
7	712-3004A	Nut, Hex Flange Lock, 5/16-18	3
9	736-0105	Washer, Bell, .401 x .870 x .063	4
10	751-0653	Tube, Exhaust	1
11	759-3744	Arrestor, Spark	1
12	721-0375	Gasket, Exhaust	1

CRANKCASE

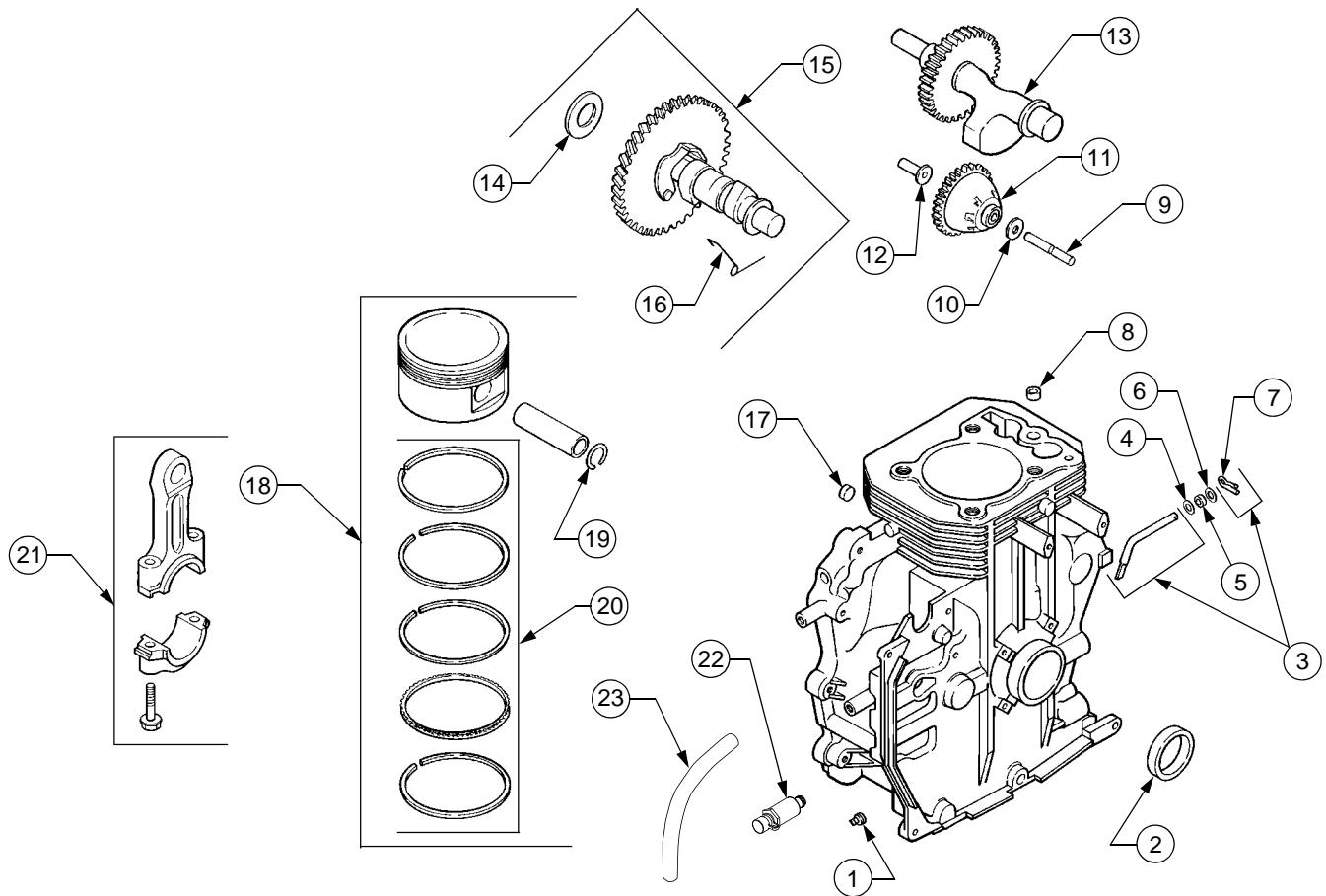

REF. NO.	PART NUMBER	DESCRIPTION	QTY.	REF. NO.	PART NUMBER	DESCRIPTION	QTY.
1	KH-25-139-57-S	Plug, Solid Sq. Head, 3/8 NPTF	2	15	KH-12-755-49	Camshaft Assy, (Incl. Ref #14,16)	1
2	KH-12-032-03	Seal, Crankshaft	1	16	KH-12-089-31	Spring, Actuating	1
3	KH-12-755-64	Kit, Gov. Cross Shaft (Incl. Ref #7)	1	17	KH-52-139-09	Plug, Cup	1
4	KH-M-631015	Washer, Governor Shaft, 6mm	1	18	KH-12-874-07	Piston w/Ring Set, Std	1
5	KH-12-032-01	Seal, Governor Cross Shaft	1		KH-12-874-11	Piston w/Ring Set, .08mm O.S.	1
6	KH-X-25-102	Washer, Plain, 1/4	1		KH-12-874-08	Piston w/Ring Set, .25mm O.S.	1
7	KH-12-154-05	Pin, Governor Hitch	1		KH-12-874-09	Piston w/Ring Set, .50mm O.S.	1
8	KH-24-380-13-S	Dowel, Locating	4	19	KH-12-018-02	Retainer, Piston Pin	2
9	KH-12-144-02	Shaft, Governor Gear	1	20	KH-12-108-07	Ring Set, Std.	1
10	KH-M-631005	Washer, Governor Gear Thrust	1		KH-12-108-08	Ring Set, .25mm	1
11	KH-12-043-05	Gear, Governor Assy	1		KH-12-108-09	Ring Set, .50mm	1
12	KH-12-380-01	Pin, Governor Regulating	1	21	KH-12-067-05	Rod, Connecting, Std	1
13	KH-12-144-26	Shaft, Balance	1		KH-12-067-06	Rod, Connecting, .25mm	1
14	KH-12-422-07	Shim,Camshaft, .0280 (White)	AR	22	751-3140	Drain, Oil	1
	KH-12-422-08	Shim,Camshaft, .0300 (Blue)	AR		751-3142	Cap	1
	KH-12-422-09	Shim,Camshaft, .0320 (Red)	AR	23	751-3141-12	Hose, Oil Drain	1
	KH-12-422-10	Shim,Camshaft, .0340 (Yellow)	AR				
	KH-12-422-11	Shim,Camshaft, .0360 (Green)	AR		KH-12-755-93-S	Gasket Set	1
	KH-12-422-12	Shim,Camshaft, .0380 (Grey)	AR		KH-45509	Engine Complete	1
	KH-12-422-13	Shim,Camshaft, .0400 (Black)	AR		KH-12-522-39	Short Block	1

CYLINDER HEAD, VALVES AND BREATHER

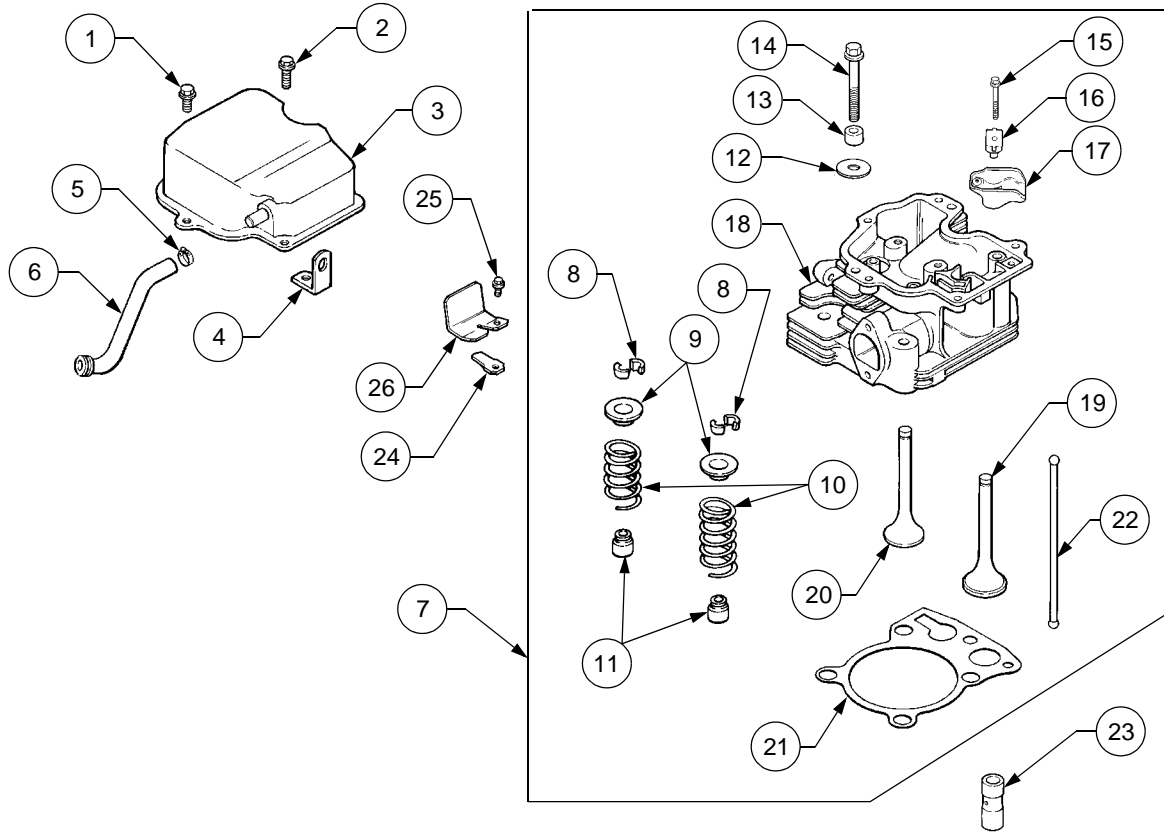

REF. NO.	PART NUMBER	DESCRIPTION	QTY.	REF. NO.	PART NUMBER	DESCRIPTION	QTY.
1	KH-M-0645016	Screw, Hex Flange, M6 x 1 x 16	4	14	KH-20-086-02-S	Screw, Hex Flange, M10 x 1.5 x 81	5
2	KH-M-645020-S	Screw, Hex Flange, M6 x 1 x 20	1	15	KH-M-0640034	Screw, Hex Flange, M6 x 1 x 34	2
3	KH-12-096-47	Cover, Valve w/Nipple	1	16	KH-12-599-03	Pivot, Rocker Arm	2
4	KH-12-445-05	Strap, Lifting	1	17	KH-25-186-01	Arm, Rocker	2
5	KH-25-237-14-S	Clamp, Hose	1	18	KH-12-318-19	Head, Cylinder	1
6	KH-12-326-19-S	Hose, Breather	1	19	KH-12-017-01	Valve, Intake (Std.)	1
7	KH-12-755-81	Kit, Cyl Head, (Includes #8-23, KH-12-041-01, KH-12-041-02, and KH-12-041-03 Gaskets)	1		KH-12-017-02	Valve, Intake (.25mm)	1
8	KH-12-755-03	Kit, Retainer	2	20	KH-12-016-01	Valve, Exhaust (Std.)	1
9	KH-12-173-01	Cap, Valve Spring	2		KH-12-016-02	Valve, Exhaust (.25mm)	1
10	KH-12-089-34-S	Spring, Valve	2	21	KH-12-041-10	Gasket, Cylinder Head	1
11	KH-66-032-05-S	Seal, Valve Stem	2	22	KH-12-411-04-S	Rod, Push	2
12	KH-12-468-05	Washer, Plain, 13/32"	1	23	KH-25-351-01	Lifter, Valve	2
13	KH-12-112-13	Spacer, Head Bolt Exhaust Port	1	24	KH-12-402-02	Reed, Breather	1
				25	KH-M-0545010	Screw, Hex Flange, M5 x .8 x 10	1
				26	KH-66-018-04	Retainer, Breather Reed	1

OIL PAN AND LUBRICATION

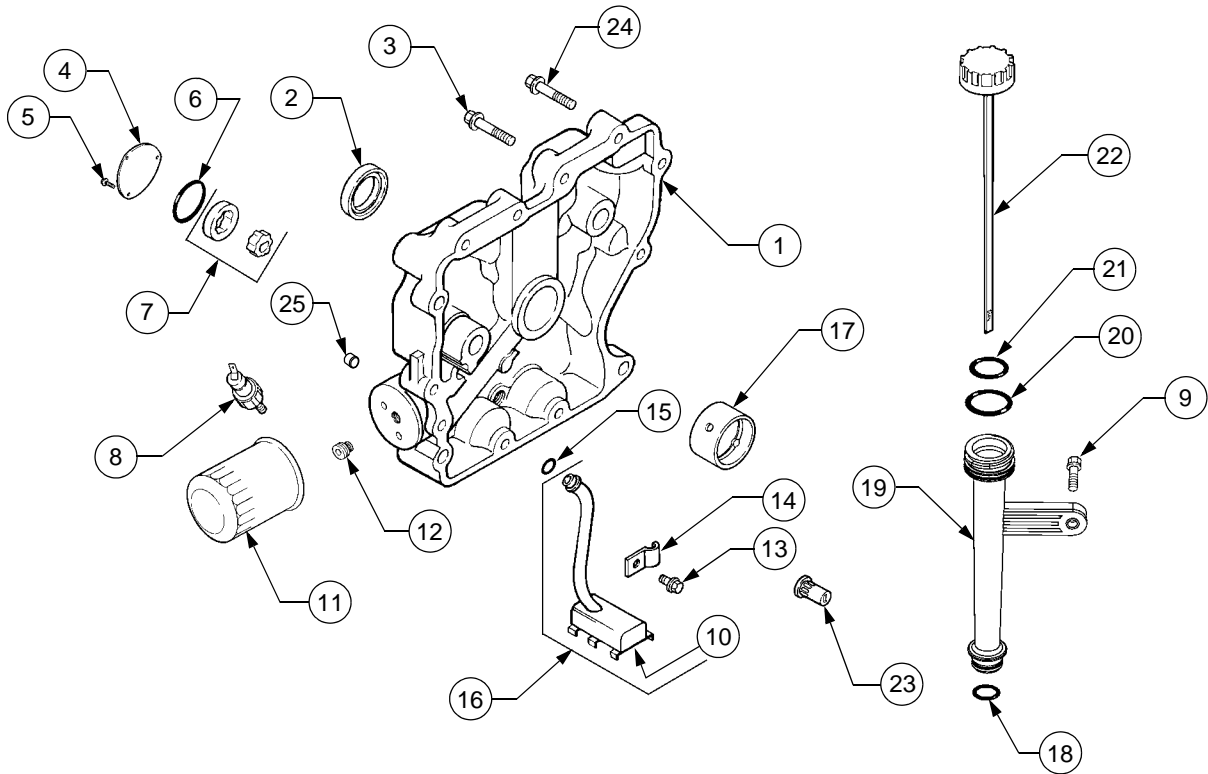

REF. NO.	PART NUMBER	DESCRIPTION	QTY.	REF. NO.	PART NUMBER	DESCRIPTION	QTY.
1	KH-12-009-51	Plate Assembly, Closure (Incl. Ref #4-7,17, 23)	1	13	KH-M-545016-S	Screw, Oil Pick-Up, M5 x .8 x 16	1
2	KH-12-032-03	Seal, Oil (PTO End)	1	14	KH-52-154-01	Clip, Oil Tube	1
3	KH-24-086-16	Screw, Closure Plate, M8x1.25x45	11	15	KH-12-153-04	O-Ring, Oil Pick-Up	1
4	KH-12-096-21	Cover, Oil Pump	1	16	KH-12-755-73	Kit, Oil Pick-Up (Incl. Ref #10)	1
5	KH-M-545016	Screw, Oil Pump Cover, M5x.8x16	3	17	KH-12-030-05	Bearing, Thrust	1
6	KH-12-153-05	O-Ring, Oil Pump	1	18	KH-12-153-07	O-Ring, Lower Oil Fill Tube	1
7	KH-12-393-01	Pump Assembly, Oil	1	19	KH-12-123-22	Tube, Oil Fill	1
8	KH-25-099-24	Switch, Oil Pressure	1	20	KH-12-153-02	O-Ring, Upper Oil Fill Tube	1
9	KH-M-545016-S	Screw, Hex Flange M5 x 0.8 x 16	1	21	KH-12-153-03	O-Ring, Dipstick Cap	1
10	KH-25-381-01	Pick-up, Oil Screen	1	22	KH-12-038-08	Cap/Dipstick, Oil Fill	1
11	KH-12-050-08	Filter, Oil	1	23	KH-25-462-09	Valve, Oil Pressure Relief	1
12	KH-24-136-01	Nipple, Oil Filter	1	24	KH-24-086-17	Screw, Hex Flange M8 x 1.25 x 45	1
				25	KH-25-139-60-S	Plug	1

BLOWER HOUSING AND BAFFLES

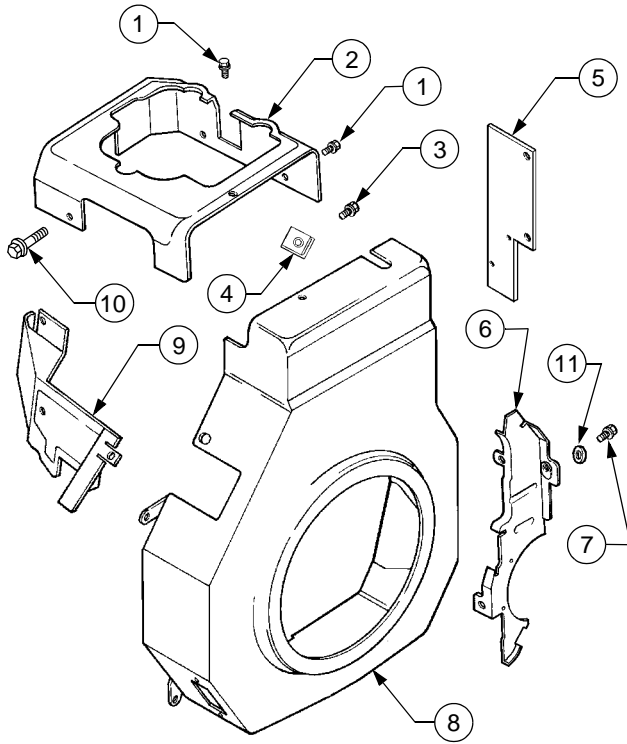

REF. NO.	PART NUMBER	DESCRIPTION	QTY.
1	KH-M-0545010	Screw, Hex Flange, M5 x .8 x 10	3
2	KH-12-063-08	Baffle, Cylinder Head	1
3	KH-M-645016-S	Screw, Hex Flange, M5 x .8 x 16	3
4	KH-25-154-02	Clip, Mounting	3
5	KH-12-063-15-S	Baffle, Cylinder	1
6	KH-12-146-07	Plate, Blower Housing	1
7	KH-12-086-37	Screw, w/Washer M5 x .8 x 20	3
8	KH-12-027-55	Housing, Blower	1
9	KH-12-063-10	Baffle, Intake Side	1
10	KH-M-550010-S	Screw, Hex Flange, M5 x 0.8 x 10	2
11	KH-24-468-10	Washer, Plain 1/4"	1

CRANKSHAFT

REF. NO.	PART NUMBER	DESCRIPTION	QTY.
1	KH-12-014-37	Crankshaft (Incl. Ref #2)	1
2	KH-12-139-01	Plug, Cup	1

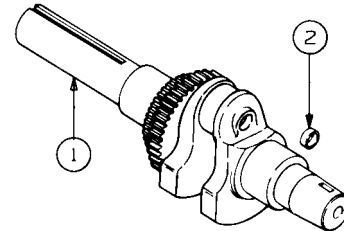

EXHAUST

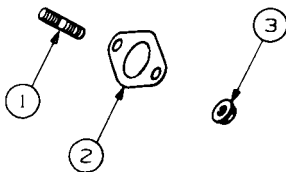

REF. NO.	PART NUMBER	DESCRIPTION	QTY.
1	KH-25-072-04	Stud, Exh Manifold, M8 x 1.25 x 33	2
2	721-0375	Gasket, Exhaust Manifold	1
3	712-3086	Nut, Muffler, M8 x 1.25	2

AIR INTAKE AND FILTER

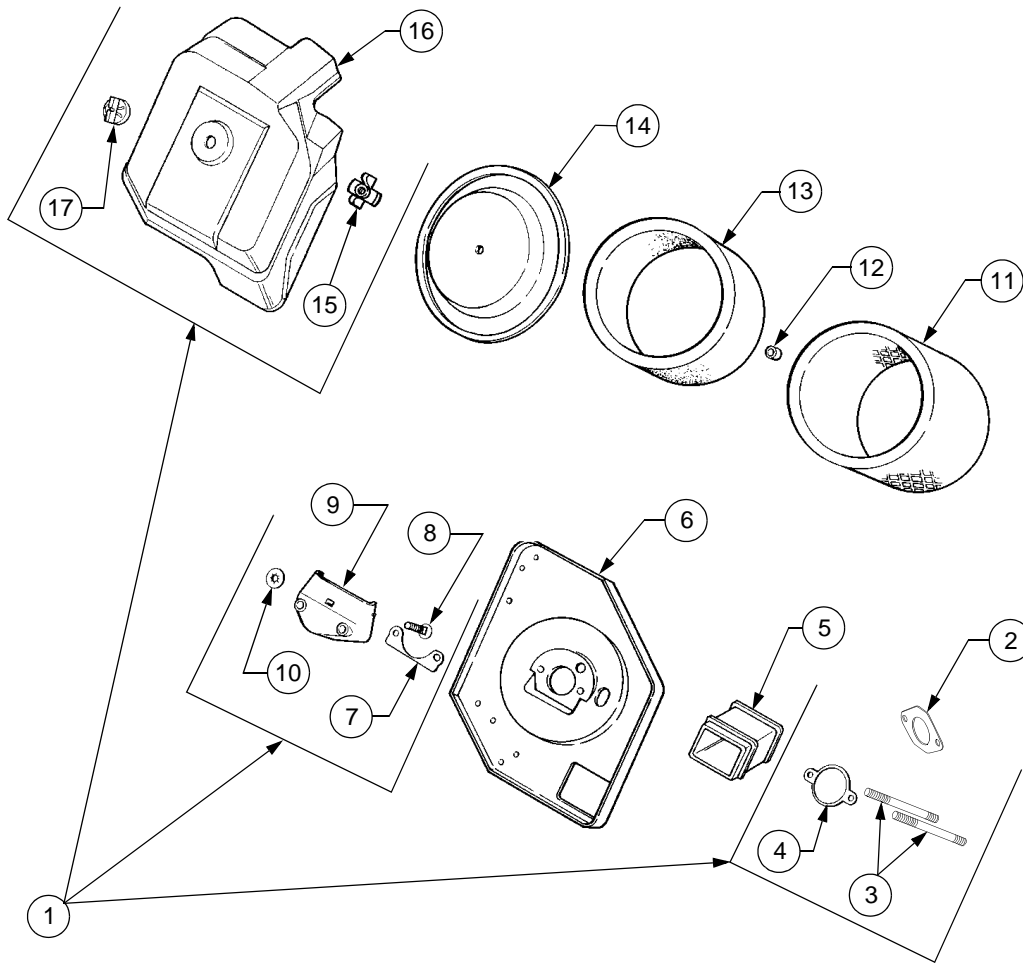

REF. NO.	PART NUMBER	DESCRIPTION	QTY.
1	KH-12-755-84	Kit, Fuel Recovery (Incl. Ref #2-4, 7-10, 12, 15-17)	1
2	KH-12-041-01	Gasket, Carburetor	1
3	KH-M-0629116	Stud, M6 x 1.0 x 116	2
4	KH-12-041-02	Gasket, Air Cleaner	1
5	KH-12-123-07	Tube, Air Cleaner	1
6	KH-12-094-06	Base, Air Cleaner	1
7	KH-12-041-09	Gasket, Collector Plate	1
8	KH-12-211-02	Bolt, Carriage, M6 x 1.0 x 22	1
9	KH-12-109-08	Cup, Fuel Spit Back	1
10	KH-12-018-06-S	Retainer, Ring	1
11	759-3547	Element, Air Cleaner	1
12	KH-24-032-03	Seal, Inner Air Cleaner	1
13	KH-52-083-01	Pre-Cleaner, Element	1
14	KH-12-096-37	Cover, Air Cleaner Element	1
15	KH-12-100-01	Wingnut, Element Cover	1
16	KH-12-096-41	Cover, Air Cleaner Base	1
17	KH-25-341-03	Knob, Air Cleaner Cover	1

FUEL SYSTEM

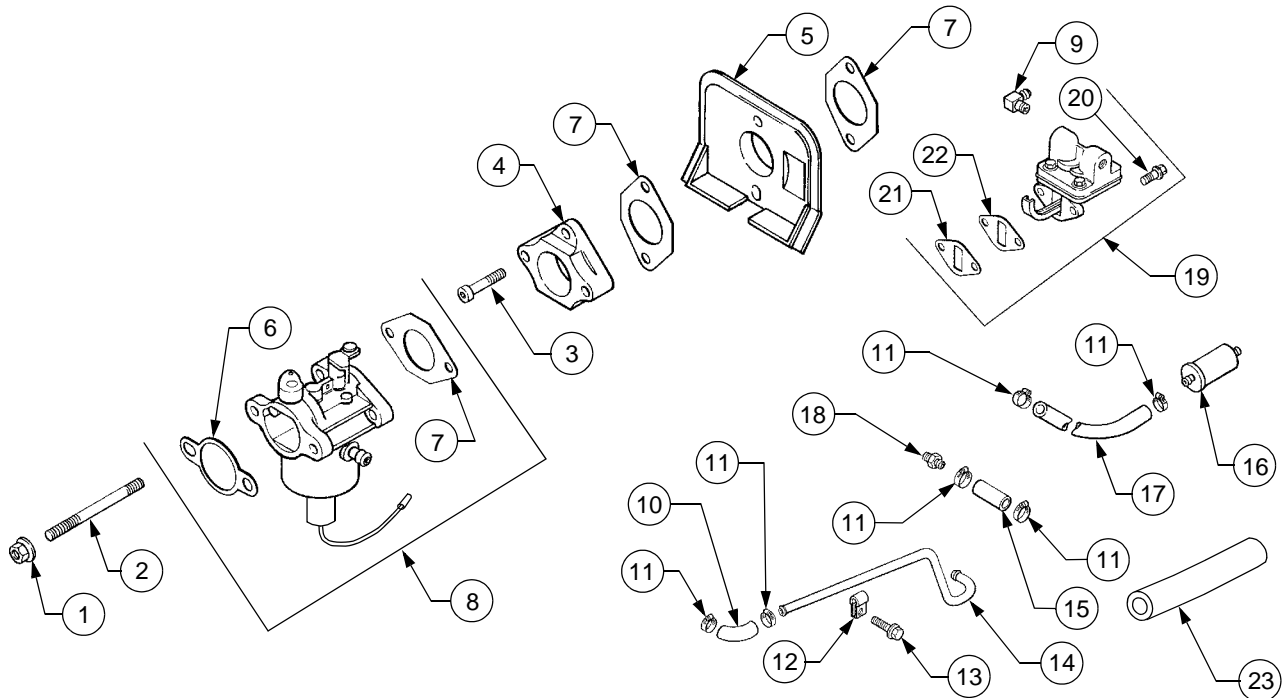

REF. NO.	PART NUMBER	DESCRIPTION	QTY.	REF. NO.	PART NUMBER	DESCRIPTION	QTY.
1	KH-M-0641060	Nut, Hex Flange, M6 x 1.0	2	22	KH-25-041-10	Gasket, Fuel Pump	2
2	KH-M-0629116	Stud, Carburetor, M6 x 1.0 x 116	2	23	723-3066-24	Insulation, Fuel Line	1
3	KH-M-0644035	Screw, Socket Cap, M6 x 1.0 x 35	2	NOT SHOWN			
4	KH-12-029-04	Adapter, Carburetor	1		KH-12-757-02	Kit, Float Assembly	1
5	KH-12-265-04	Deflector, Heat	1		KH-12-757-03	Kit, Carburetor Repair — Includes Gasket, Carburetor Gasket, Air Filter Base Gasket, Fuel Bowl Gasket, Bowl Screw	1
6	KH-12-041-02	Gasket, Air Filter	1		KH-12-757-08	Kit, Choke Repair — Includes Shaft Assembly, Choke Plate, Choke Bushing, Choke Cap, Choke Lever Screw, Valve (2)	1
7	KH-12-041-01	Gasket, Carburetor	3		KH-12-757-33	Kit, Solenoid Repair — Includes Gasket, Bowl Screw, Tie, Wire Terminal	1
8	KH-12-853-93	Kit, Carb w/Gskts [Incl. Ref #6, 7(1), KH-12-454-03-S (Wire Tie) and KH-25-452-20 (Terminal)]	1		KH-12-757-37-S	Kit, Bowl Replacement	1
9	KH-12-294-13-S	Connector, Hose, 90°	1		KH-12-755-92-S	Kit, High Altitude	1
10	KH-12-353-07	Line, 90° Fuel	1		KH-25-153-04-S	O-Ring, Fuel Pump	1
11	KH-25-237-14-S	Clamp, Fuel Line	6	†	KH-M-561010	Screw, Thrd Forming M5 x .8 x 10	1
12	KH-X-728-1	Clip, Tube	1	†	KH-X-22-11	Washer, Lock 1/4"	1
13	KH-M-0545010	Screw, Hex Flange, M5 x .8 x 10	1				
14	KH-12-353-11	Line, Metal Fuel	1				
15	KH-12-353-01	Line, Fuel, 1 1/4"	1				
16	KH-25-050-07-S	Filter, Fuel	1				
17	KH-25-353-08	Line, Fuel, 5"	1				
18	KH-25-294-09-S	Connector, Straight Hose	1				
19	KH-12-559-02	Kit, Fuel Pump (Incl. 9, 20-22)	1				
20	KH-M-0645020	Screw, Hex Flange, M6 x 1 x 20	2				
21	KH-12-112-05	Spacer, Fuel Pump	1				

† Used to Attach Carburetor Ground Lead

ENGINE CONTROLS

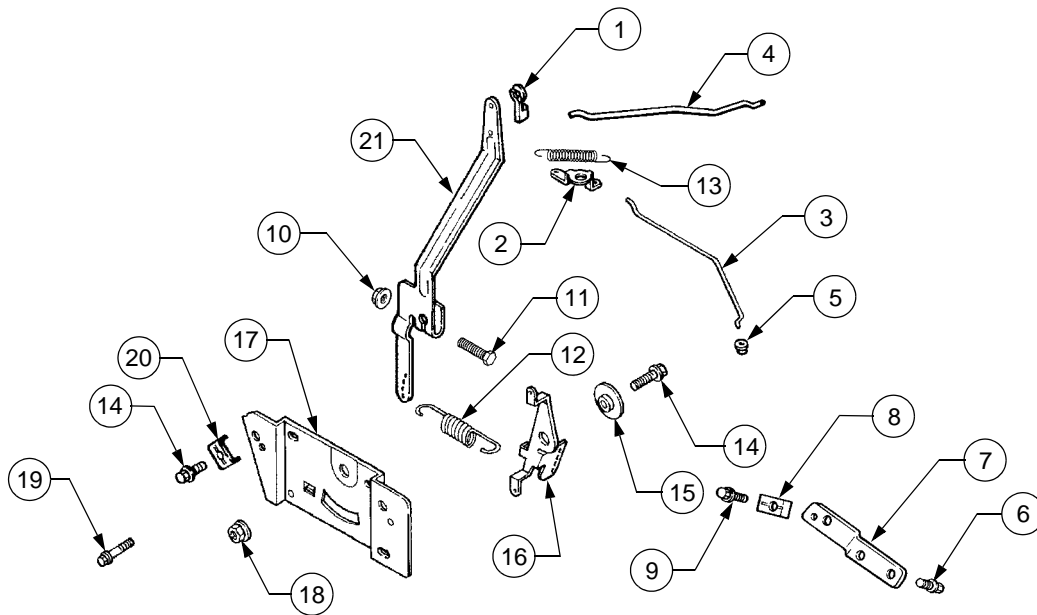

REF. NO.	PART NUMBER	DESCRIPTION	QTY.
1	KH-25-158-11	Bushing, Throttle	1
2	KH-12-090-14	Lever, Choke, Upper	1
3	KH-12-079-08	Linkage, Choke, Upper	1
4	KH-12-079-04	Linkage, Throttle	1
5	KH-25-158-08	Bushing, Linkage	1
6	KH-M-0545010	Screw, Bracket, M5 x .8 x 10	3
7	KH-12-126-15	Bracket, Choke Mount	1
8	KH-12-237-01	Clamp, Cable	1
9	KH-M-0545016	Screw, Clamp, M5 x .8 x 16	1
10	KH-M-0641060	Nut, M6 x 1	1
11	KH-12-086-41-S	Screw, Governor Arm, M6 x 1 x 25	1
12	KH-12-089-17	Spring, Governor	1
13	KH-230117	Spring, Linkage	1
14	KH-M-545016-S	Screw, Throttle Cntrl, M5 x .8 x 16	2
15	KH-12-112-07	Spacer, Throttle Control	1
16	KH-12-090-13	Lever, Throttle Control	1
17	KH-12-146-05	Plate, Control	1
18	KH-M-0541050	Nut, Hex, M5 x .8	1
19	KH-M-0664020	Screw, Control Plate, M6 x 1 x 20	2
20	KH-12-237-01	Clamp, Cable	2
21	KH-12-090-19	Lever, Governor	1

STARTING SYSTEM

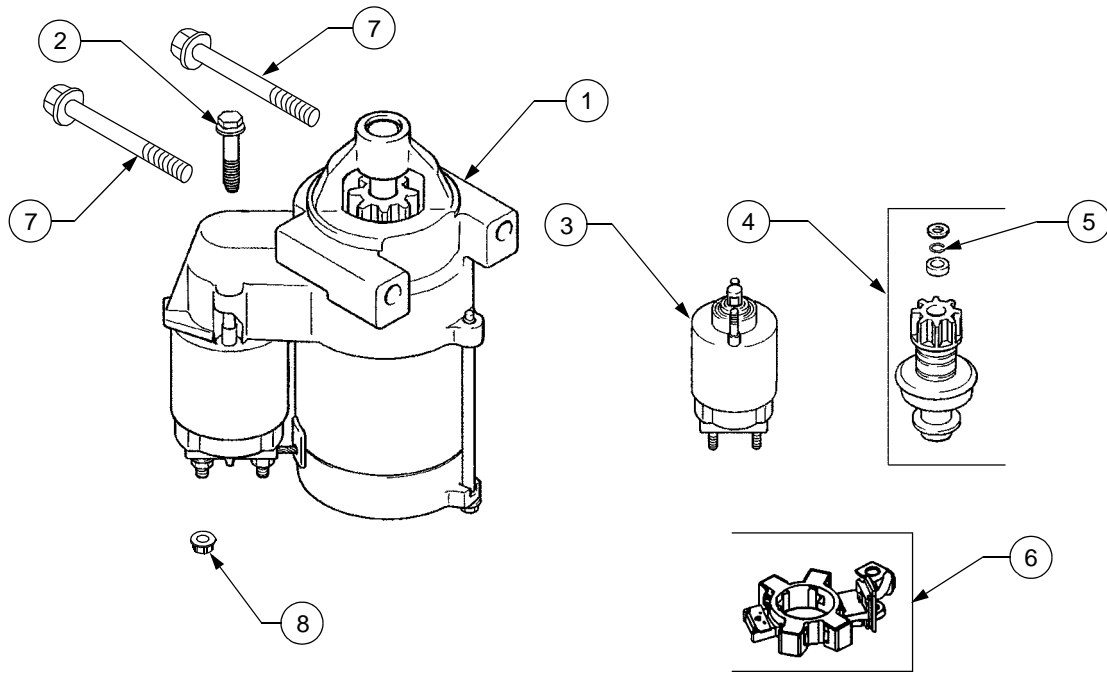

REF. NO.	PART NUMBER	DESCRIPTION	QTY.
1	KH-25-098-09-S	Starter, (Incl. Ref #2-6)	1
2	KH-25-086-113-S	Screw, External Torx Hd.	3
3	KH-25-435-05-S	Kit, Solenoid (Includes Ref. #2)	1
4	KH-25-755-33-S	Kit, Pinion Drive (Includes Ref. 5)	1
5	KH-25-141-05-S	Ring	1
6	KH-25-221-01-S	Kit, Brush	1
7	KH-M-839080	Screw, Hex Flange, M8 x 1.25 x 80	2
8	KH-M-0841080	Nut, Hex Flange, M8 x 1.25	1

IGNITION/ELECTRICAL

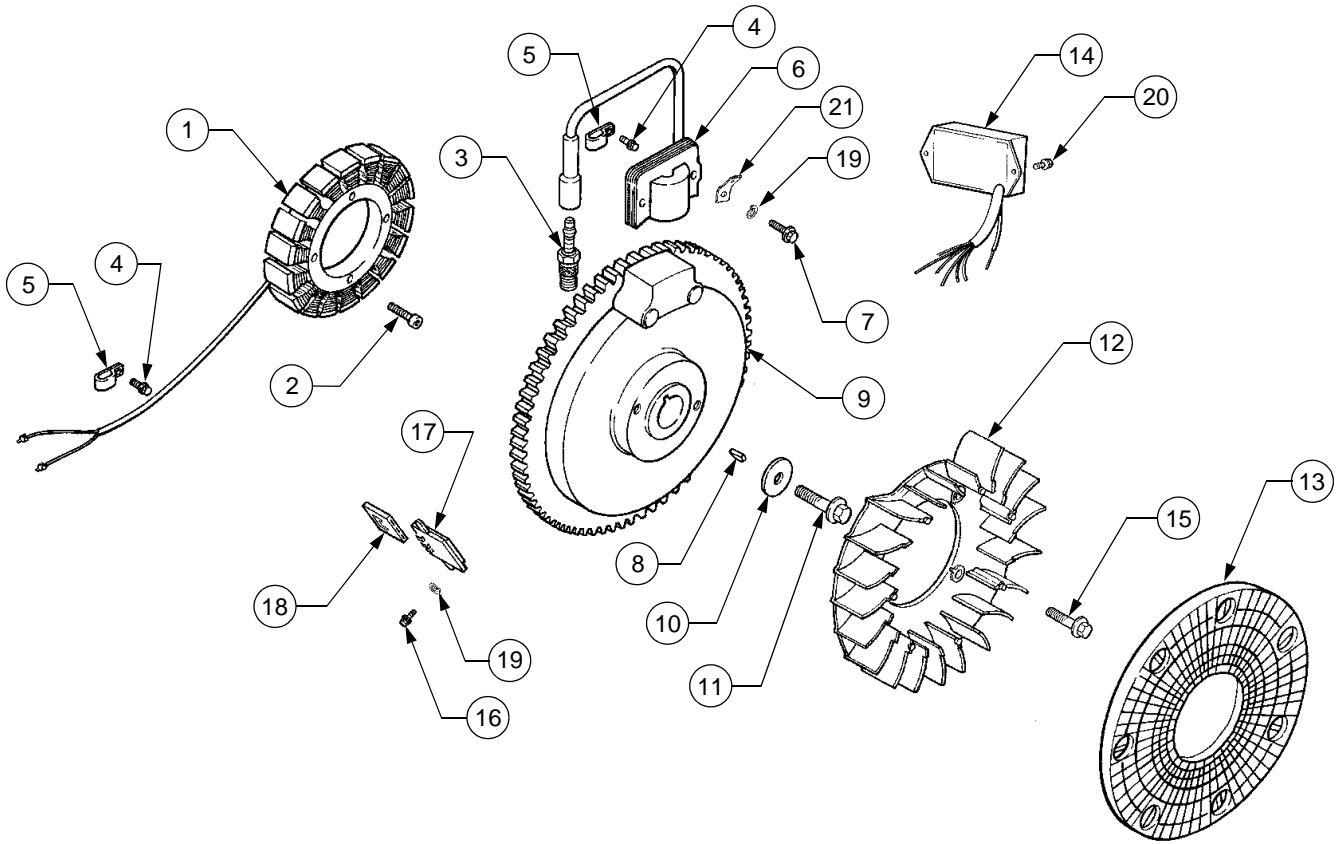

REF. NO.	PART NUMBER	DESCRIPTION	QTY.	REF. NO.	PART NUMBER	DESCRIPTION	QTY.
1	KH-237878	Kit, Stator, (Includes Ref #2 and KH-25-452-01 Terminal, Qty 2)	1	14	KH-12-584-12	Module, Digital Speed Advance	1
2	KH-M-548025-S	Screw, Stator Mntg, M5 x 0.8 x 25	2	15	KH-25-086-47	Bolt, Shoulder M6 x 1 x 16	4
3	759-3336	Spark Plug	1	16	KH-24-086-18-S	Screw, Phillips Hd. 11-16 x 7/8	2
4	KH-M-0545010	Screw, Harness Clip, M5 x .8 x 10	2	17	KH-41-403-09	Rectifier-Regulator	1
5	KH-X-728-1	Clip, Cable	2	18	KH-236602	Connector, Three Contact	1
6	KH-12-584-14-S	Module, Ignition	1	19	KH-X-22-11	Washer, Lock, 1/4	2
7	KH-12-086-35-S	Screw, Ign Module, M4 x .7 x 4.0	2	20	KH-M-461013	Screw, Pan Head, M4.2 x 13	2
8	KH-X-42-15	Key	1	21	KH-12-452-02-S	Terminal	1
9	KH-12-025-46-S	Flywheel	1	†	KH-24-518-12-S	Lead, Black, 4"	1
10	KH-12-468-03	Washer, Flywheel	1	†	KH-12-176-51-S	Harness, Wire	1
11	KH-12-086-14	Screw, Flywheel, M10 x 1.5 x 46	1	†	KH-12-154-07-S	Clip, Rectifier/Regulator	2
12	KH-12-157-03	Fan	1	†	KH-M-445010	Screw, Hex Flange M4 x.7 x 10 (To attach harness to baffle)	2
13	KH-12-162-05	Screen, Grass	1				

† Not Shown

GRILLE, HOOD AND SIDE PANELS

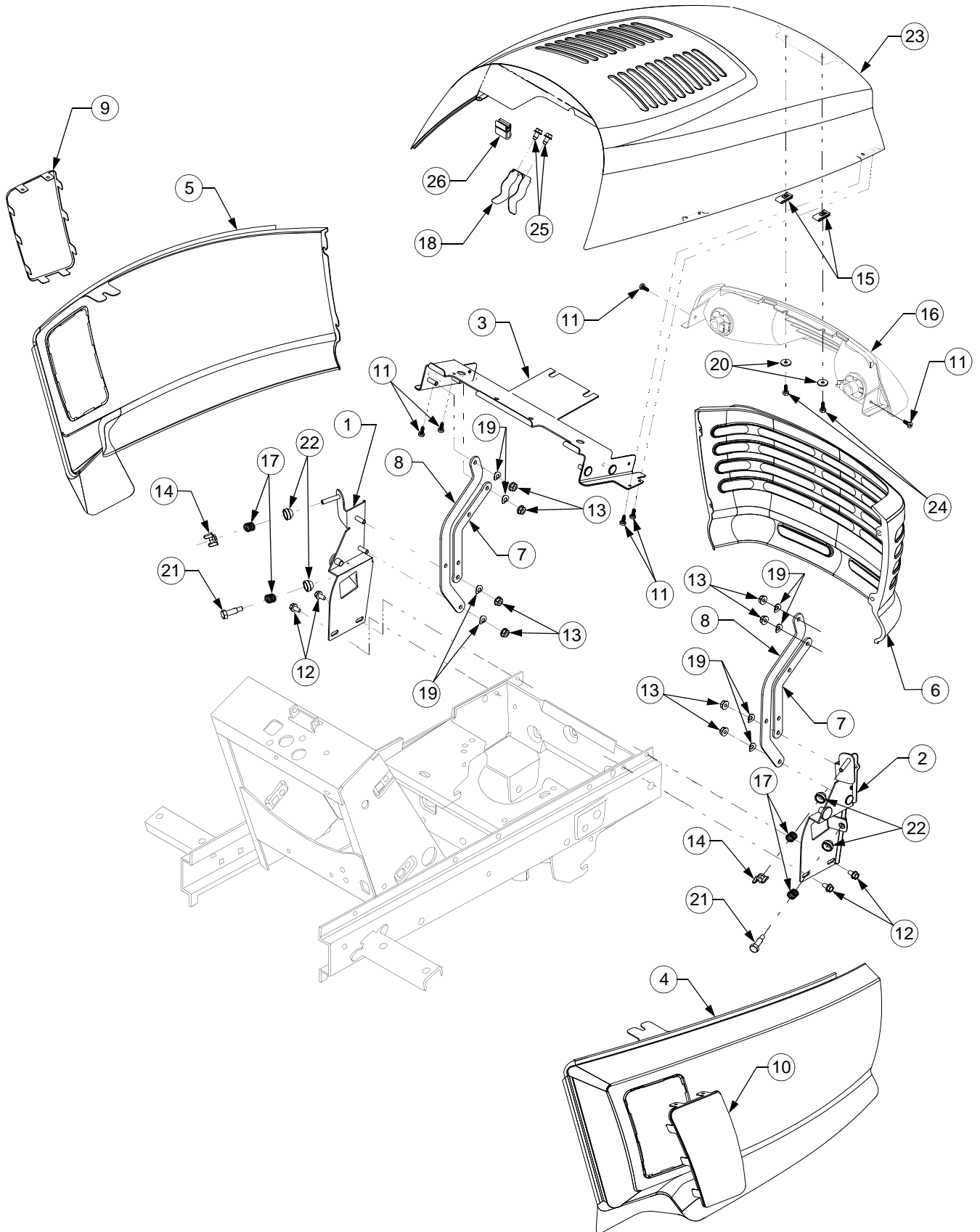

GRILLE, HOOD AND SIDE PANELS

REF. NO.	PART NUMBER	DESCRIPTION	QTY.
1	603-0211	Bracket, Grille LH	1
2	603-0212	Bracket, Grille RH	1
3	603-04063	Bracket, Upper Hood	1
4	703-2396	Panel, RH Side	1
	777D07671	Graphic, LT2138	1
	777X40079	Strip, Protective	1
5	703-2397	Panel, LH Side	1
	777D07671	Graphic, LT2138	1
	777X40079	Strip, Protective	1
6	703-2398	Grille	1
	777I20314	Graphic, Warning HOT	1
7	703-2465	Link, Short Hood	2
8	703-2466A	Link, Long Hood	2
9	703-2495	Screen, LH Panel	1
10	703-2496	Screen, RH Panel	1
11	710-0351	Screw, Truss Mach Tapp, #10 x .50	6
12	710-0599	Screw, Hex Wash Hd Tapp, 1/4 x .50	4
13	712-3027	Nut, Hex Flange Lock, 1/4-20	8
14	712-0397	Nut, Wing, 1/4-20	2
15	726-0139	Nut, U-Type Speed, #10	2
16	625-04001A	Headlight Assy (Includes Lamp and Socket)	1
	725-0963	Lamp, 12V	2
	725-1649	Socket, Lamp	2
	777X41348	Reflector, Headlight	1
17	732-0334	Spring, Compression, .50 OD x .50	4
18	732-1178	Spring, Hood Latch	1
19	736-0175	Washer, Spring, .265 x .562 x .025	8
20	736-0400	Washer, Flat, .218 x .62 x .063	2
21	738-3141	Bolt, Shoulder, .31 Dia x .75 Lg	2
22	748-3055	Bushing, Tapered	4
23	959-3747B	Hood, Series 2000	1
	777D07681	Graphic, Hood - RH	1
	777D07682	Graphic, Hood - LH	1
24	710-0436	Screw, Hex Tapp, 10-16 x .625	2
25	710-1005	Screw, Hex Wash Hd Tapp, 1/4-14 x .5	2
26	723-3061-19	Seal, Heat Baffle	19in

FENDER AND RUNNING BOARD

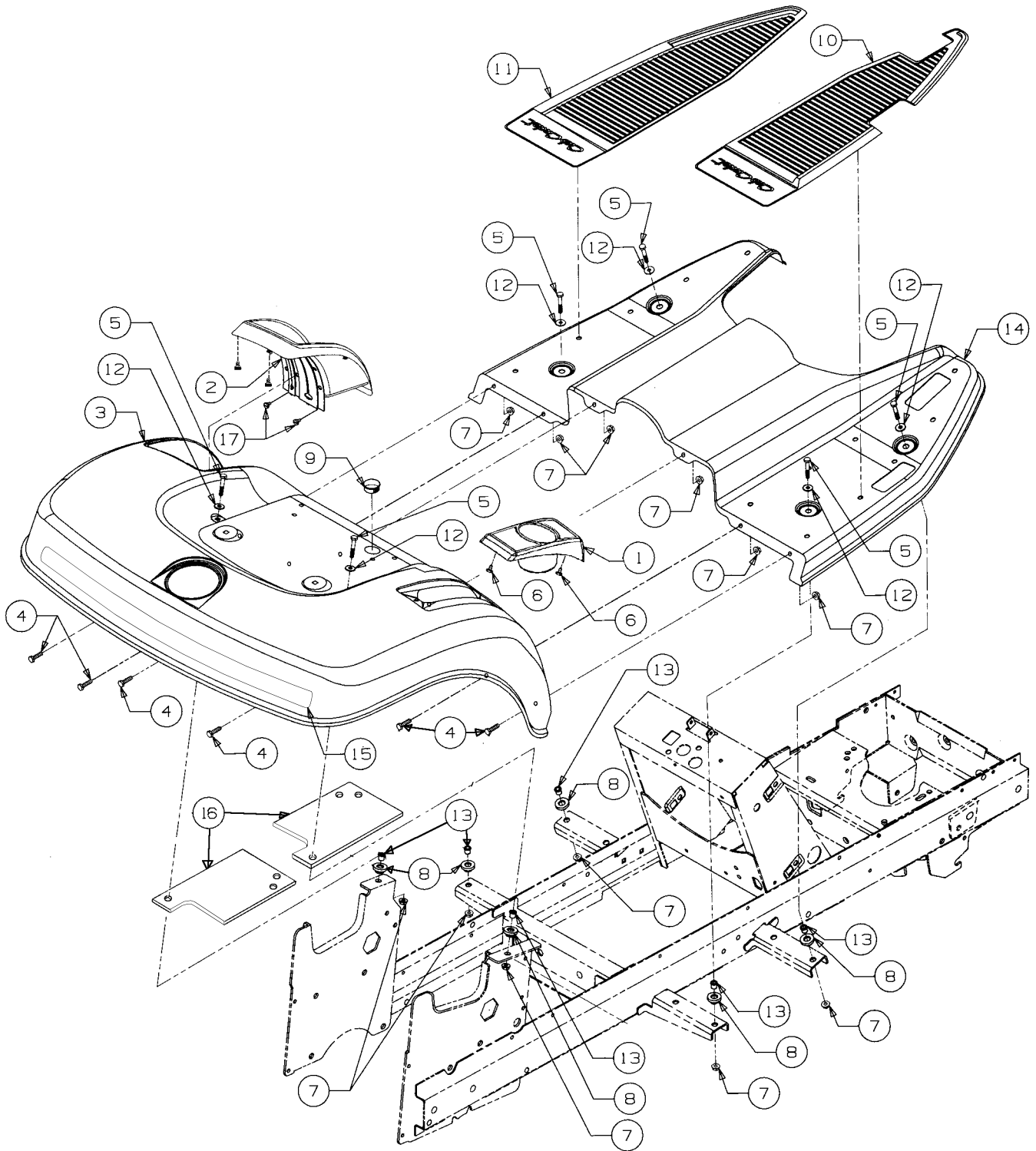

FENDER AND RUNNING BOARD

REF. NO.	PART NUMBER	DESCRIPTION	QTY.
1	731-3212	Cup Holder	1
2	631-3002	Cover, Implement Lift	1
3	703-2278B	Fender	1
4	710-0751	Screw, Hex Cap, 1/4-20 x .62	6
5	710-0597	Screw, Hex Cap, 1/4-20 x 1.0	6
6	710-1268	Screw, Hex Tapp, #10 x .38 Lg	2
7	712-3027	Nut, Hex Flange Lock, 1/4-20	12
8	722-0258	Grommet, Insulator	6
9	723-3042	Bushing, Snap, 7/8 ID	1
10	735-3046A	Pad, RH Foot	1
11	735-3047	Pad, LH Foot	1
12	736-3090	Washer, Flat, .255 x .72 x .06	6
13	750-3169	Spacer, .28 ID x .40 OD x .42 Lg	6
14	703-2279	Running Board w/Graphic	1
	777S30170	Graphic, Warning	1
15	777D07926	Graphic, Rear Fender	1
16	703-2628	Bracket, Fender Reinforcement	2
17	710-0224	Screw, Hex Tapp, #10-16 x .5	4

IMPLEMENT LIFT HANDLE

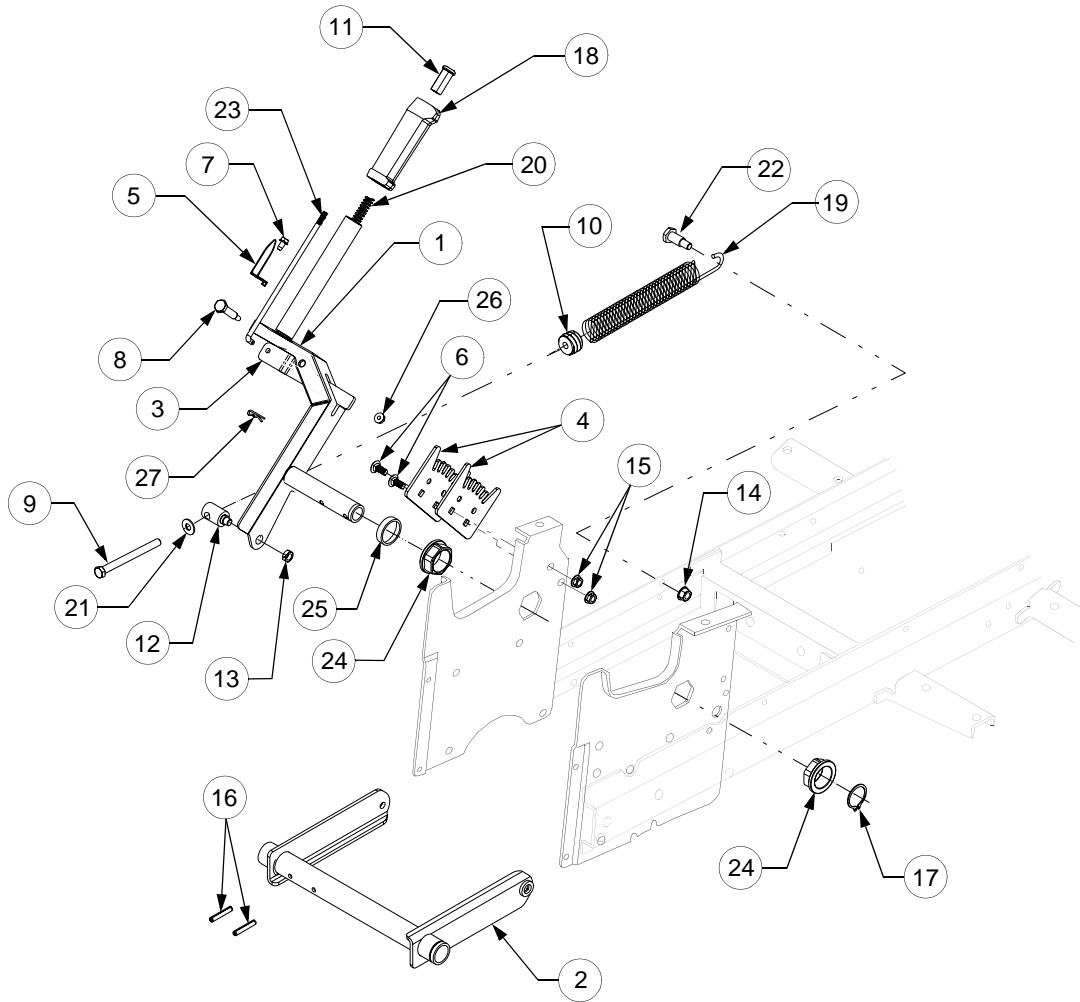

REF. NO.	PART NUMBER	DESCRIPTION	QTY.	REF. NO.	PART NUMBER	DESCRIPTION	QTY.
1	603-04141	Handle Assembly, Lift	1	14	712-0431	Nut, Hex Flanged Lock, 3/8-16	1
2	603-0059A	Shaft Assembly, Lift	1	15	712-3004A	Nut, Hex Flanged Top Lock, 5/16-18	2
3	603-05247	Fork, Lift	1	16	715-0114A	Pin, Spiral Spring, 1/4 Dia x 1.5	2
4	703-2239A	Bracket, Lift Index	2	17	716-0116	Ring, Snap, 1.25 Dia Shaft	1
5	703-2558	Indicator, Lift Height	1	18	731-3158	Grip, Lift Handle	1
6	710-0451	Bolt, Carriage, 5/16-18 x .75	2	19	732-3093	Spring, Extension	1
7	710-0599	Screw, Hex Wash Tapp, 1/4 x .5	1	20	732-3097	Spring, Compression	1
8	738-0560	Screw, Shoulder, .374 x 1.375	1	21	736-0267	Washer, Flat, .385 x .87 x .06	1
9	710-3279	Screw, Hex Cap, 3/8-16 x 4.25 GR5	1	22	738-0145	Bolt, Shoulder	1
10	711-0635	Insert, Spring	1	23	747-3175A	Rod, Index	1
11	711-0642A	Button, Handle	1	24	748-3051	Bearing, Hex Flange, 1.25 ID	2
12	711-3350	Ferrule, Adjustment	1	25	750-3131	Spacer, 1.28 ID x 1.5 OD x .335 Lg	1
13	712-0262	Nut, Hex Center Lock, Jam, 3/8-24	1	26	712-3027	Nut, Hex Flange Lock, 1/4-20	1
				27	714-0104	Pin, Internal Cotter	1

IMPLEMENT LIFT HANGER

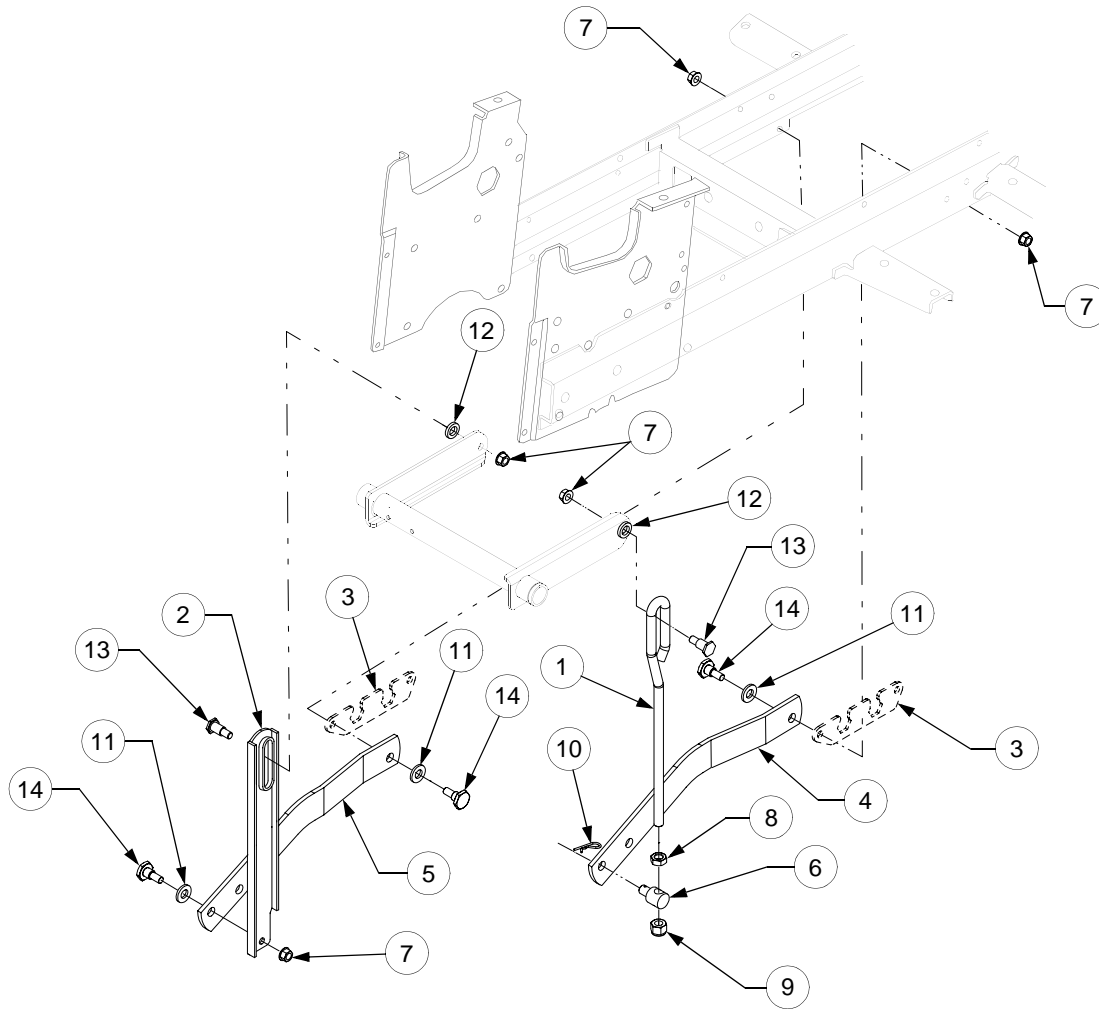

REF. NO.	PART NUMBER	DESCRIPTION	QTY.
1	747-04196	Rod, Lift Link	1
2	703-2234	Bracket, LH Hanger	1
3	703-2804	Plate, Bearing Mounting	2
4	703-2832	Link, RH Lift	1
5	703-2833	Link, LH Lift	1
6	711-3319	Ferrule, Adjustment	1
7	712-0431	Nut, Hex Flange Lock, 3/8-16	5
8	712-3048	Nut, Hex Jam, 1/2-13 GR5	1
9	712-3083	Nut, Hex Insert Lock, 1/2-13	1
10	714-0145	Pin, Internal Cotter	1
11	736-0326	Washer, Flat, .5 x 1.5 x .15	3
12	736-3069	Washer, Flat, .531 x .875 x .15	2
13	738-0430	Bolt, Shoulder	2
14	738-0507B	Bolt, Shoulder	3

38" DECK ASSEMBLY

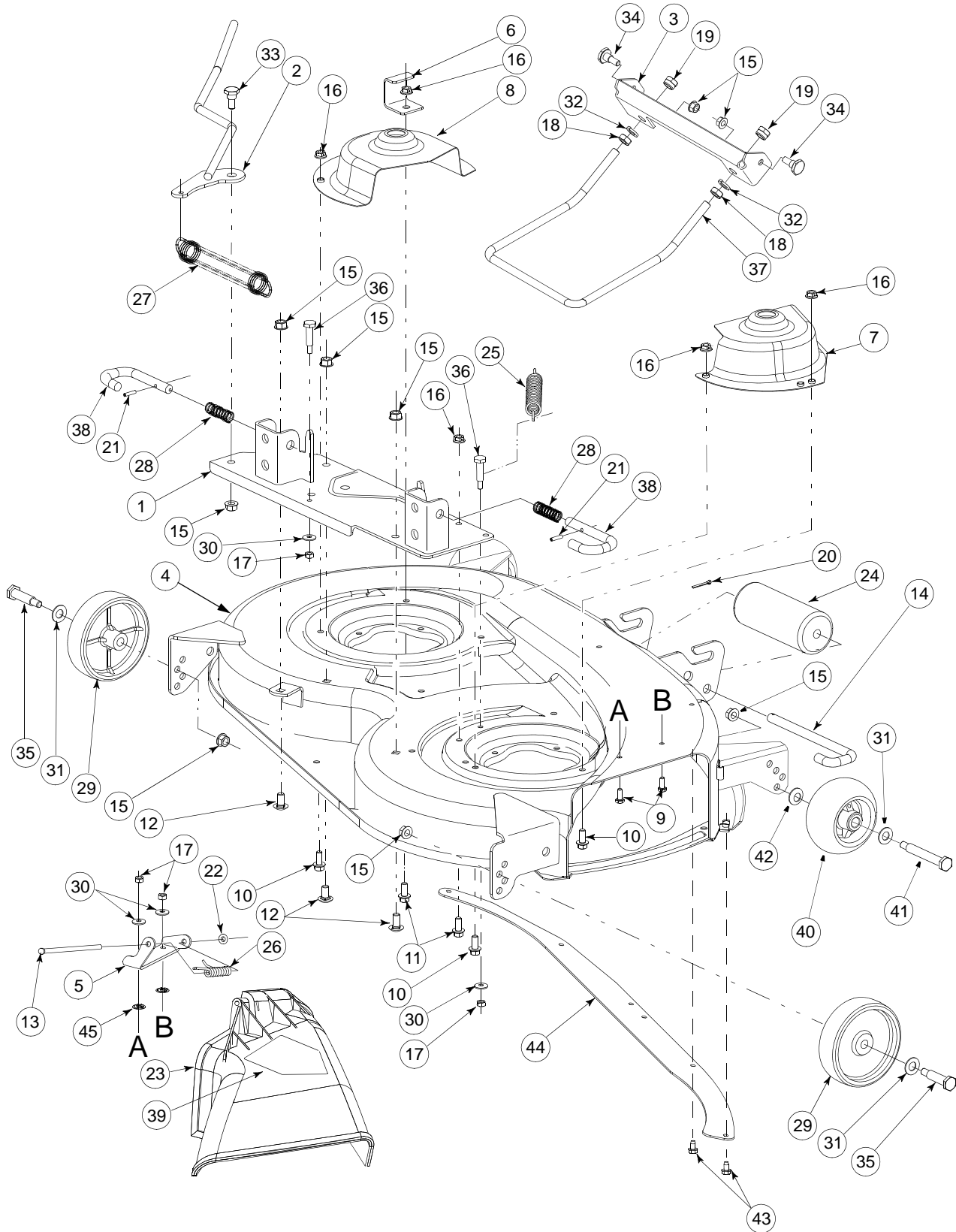

38" DECK ASSEMBLY

REF. NO.	PART NUMBER	DESCRIPTION	QTY.
1	603-0181A	Plate Assembly, Mounting	1
2	603-0199	Handle, Tension	1
3	703-2248	Bracket, Front Lift	1
4	603-0408B	Deck Assembly, 38"	1
	777S30503	Graphic, Danger Top/RH Deck	1
	777S30014	Graphic, Tension Lever	1
	777S30018	Graphic, Safety Top/LH Deck	1
	777D07929	Graphic, Cut	1
	777D07873	Graphic, 38" Cut	2
5	703-1693A	Bracket, Hinge Mounting	1
6	703-2559	Bracket, Handle Stop	1
7	703-3237	Shield, RH Pulley	1
8	703-2945	Shield, LH Pulley	1
9	710-0751	Screw, Hex Cap, 1/4-20 x .62 GR5	2
10	710-1260A	Screw, Hx Wsh Hd Tapp, 5/16-18 x .75	3
11	710-3008	Screw, Hex Cap, 5/16-18 x .75 GR5	2
12	710-3178	Bolt, Carriage, 3/8-16 x .75	3
13	711-0792	Pin, Hinge, .25 Dia x 6.75 Lg	1
14	711-3314	Pin, Roller, 1/2 Dia x 7.31 Lg	1
15	712-0431	Nut, Hex Flange Lock, 3/8-16	10
16	712-3004A	Nut, Hex Flange Lock, 5/16-18 GR5	5
17	712-3006	Nut, Hex, 1/4-20	4
18	712-3048	Nut, Hex Jam, 1/2-13 GR5	2
19	712-3083	Nut, Hex Insert Lock, 1/2-13	2
20	714-3004	Pin, Cotter, 3/32 x 1.25	1
21	715-3003	Pin, Spirol Spring, 3/16 x .75	2
22	726-0106	Cap, Speed Nut	1
23	731-1032B	Deflector Assy, (Incl. #5, 13, 22, 26, 45)	1
24	731-3005	Roller	1
25	732-0262	Spring, Extension, .88 OD x 6.12	1
26	732-0602A	Spring, Torsion	1
27	732-3115	Spring, Extension, 1.25 OD x 8.15	1
28	732-3127	Spring, Compression	2
29	734-0973	Wheel, Deck, 5 in. Dia	2
30	736-0270	Washer, Bell, .265 x .75 x .062	4
31	736-0272	Washer, Flat, .510 x 1.0 x .060	4
32	736-0921	Washer, Lock, 1/2	2
33	738-0143	Bolt, Shoulder, .498 Dia x .340 Lg	1
34	738-507B	Bolt, Shoulder, .50 Dia x .434 Lg	2
35	738-0533	Bolt, Shoulder, .498 Dia x 1.64 Lg	2
36	738-0572	Bolt, Shoulder, .375 Dia x 1.16 Lg	2
37	747-3172B	Rod, Front Lift	1
38	747-3188	Pin, Mower Support	2
39	777S30284	Graphic, Danger	1
40	703-1890	Wheel, Deck w/Fitting	2
	737-0280	Lube Fitting	2
41	738-3056	Bolt, Shoulder, 1/2 x 2.5	2
42	736-0105	Washer, Bell, .401 x .870 x .063	2
43	710-0599	Screw, Self Tapping, 1/4-20 x .5	6
44	783-1297	Skirt, Deck	1
45	726-0233	Nut, Push, 1/4	2

38" SPINDLE ASSEMBLY

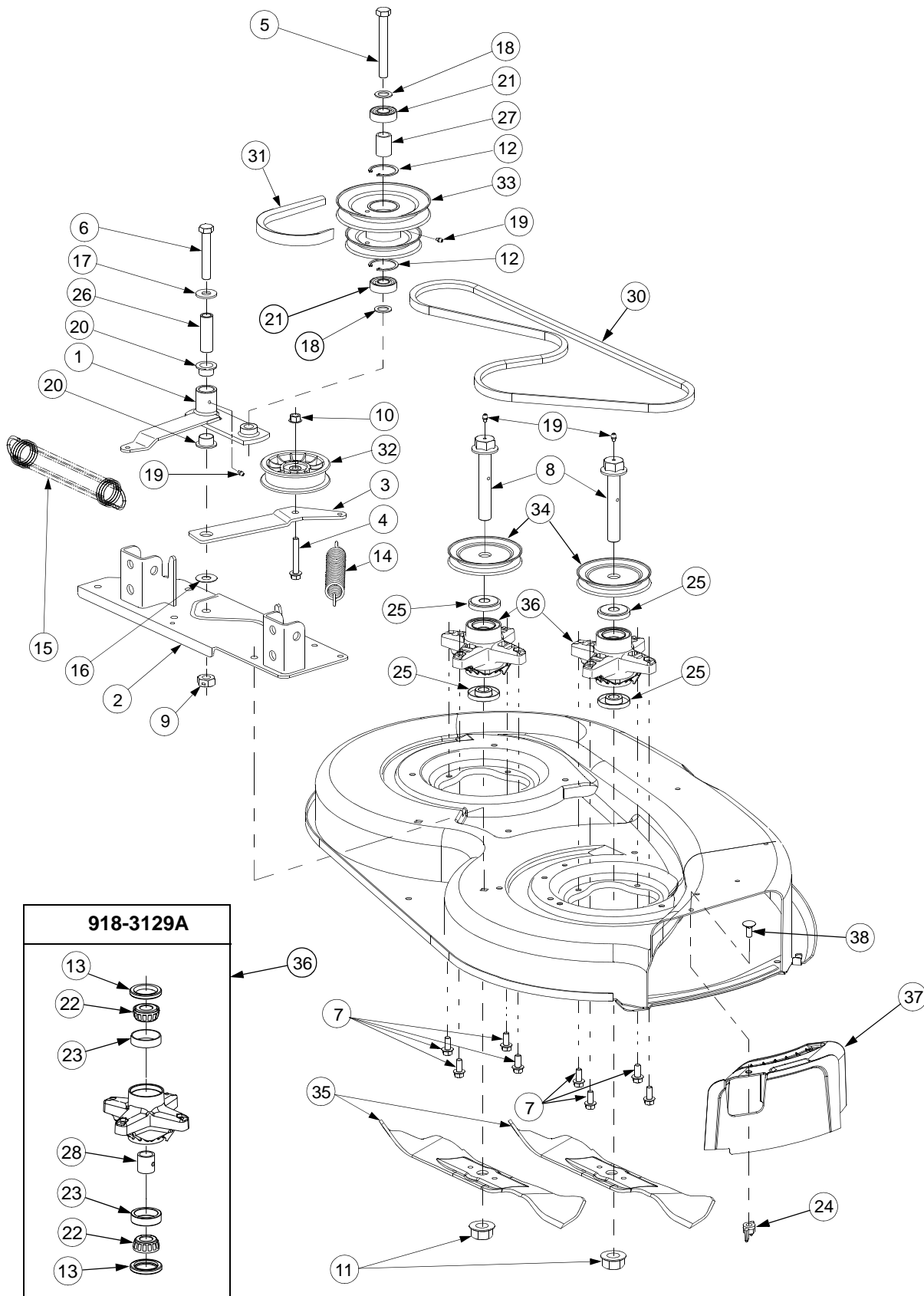

38" SPINDLE ASSEMBLY

REF. NO.	PART NUMBER	DESCRIPTION	QTY.
	603-0857	Pivot Arm, Double Pulley	1
2	603-0181A	Plate Assembly, Mounting	1
3	703-2463	Arm, Idler	1
4	710-0520	Screw, Hex Cap, 3/8-16 x 1.5 GR5	1
5	710-0923	Screw, Hex Cap, 5/8-18 x 3.0 GR5	1
6	710-1010	Screw, Hex Cap, 1/2-20 x 3.0 GR8	1
7	710-1260A	Screw, Hex Wsh Hd Tap, 5/16-18 x .75	8
8	710-1336A	Bolt, Spindle, 3/4-16 x 4.25	2
9	712-0239	Nut, Hex Center Lock, 1/2-20	1
10	712-0431	Nut, Hex Flange Lock, 3/8-16	1
11	712-3078	Nut, Hex Flange, 3/4-16	2
12	716-3020	Snap Ring, Internal	2
13	721-3018A	Seal, Oil, 1.25 x 1.874 x .25	4
14	732-0262	Spring, Extension, .88 x 6.12	1
15	732-3115	Spring, Extension, 1.25 x 8.15	1
16	736-0100	Washer, Flat, .531 x 1.25 x .036	1
17	736-0179	Washer, Flat, .531 x 1.25 x .100	1
18	736-0237	Washer, Flat, .65 x 1.25 x .075 Hdn.	2
19	737-3000	Fitting, 3/16 Drive Lube	4
20	741-0338	Bearing, Flange, 3/4 ID x .53 Lg	2
21	741-1122	Bearing, .625 ID x 1.574 OD x 470	2
22	741-04089	Cone, Bearing	4
23	741-04091	Cup, Bearing	4
24	712-3087	Nut, Wing, 1/4-20	1
25	748-3065	Spacer, Deck Spindle	4
26	750-0656	Spacer, Idlr Brkt .50 ID x .75 OD x 2.25	1
27	750-3132	Spacer, Pulley .635 ID x .88 OD x 1.25	1
28	750-3190A	Spacer, Bearing, .780 x .963 x .777	2
30	754-3029	Belt, Spindle, A-Section x 59 Lg	1
31	754-04041	Belt, PTO, B-Section x 111.2 Lg	1
32	756-0627B	Pulley, Flat Idler, 3.5 OD	1
33	756-3113	Pulley, Double	1
	737-3000	Fitting, 3/16 Drive Lube (Not Incl. w/ #33)	2
34	756-3089	V-Pulley, 4.0 Dia	2
35	759-3829	Blade, 3 In One, 19.38 Lg	2
36	618-3129B	Spindle, Blade	2
37	731-2363	Plug, Mulch	1
38	710-0134	Screw, Carriage, 1/4-20 x .62	1

FRONT AXLE AND CONNECTIONS

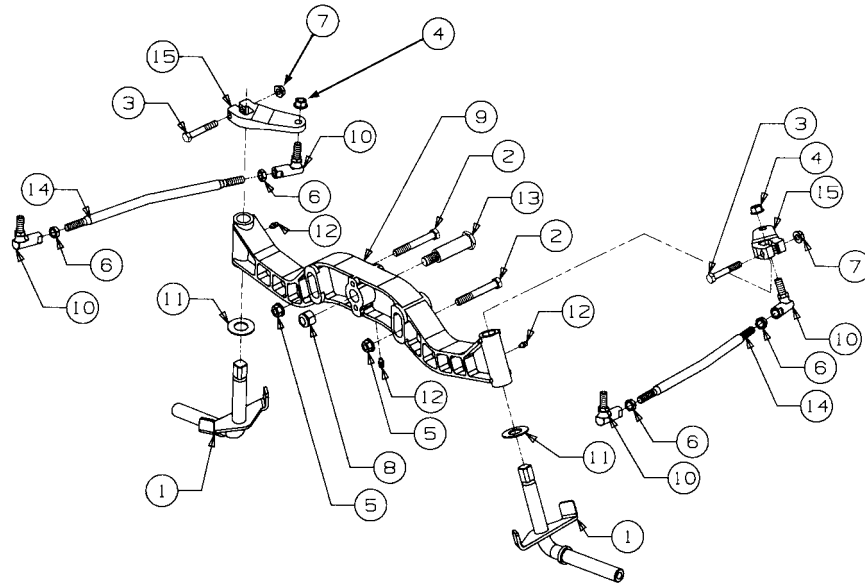

REF. NO.	PART NUMBER	DESCRIPTION	QTY.	REF. NO.	PART NUMBER	DESCRIPTION	QTY.
1	603-0066	Knuckle Assembly, Steering	2	9	719-3095	Axle, Front Pivot	1
2	710-3066	Screw, Hex Cap, 3/8-16 x 2.75 GR8	2	10	723-0156	Joint, Ball, 3/8-24	4
3	710-3103	Screw, Hex Cap, 5/16-18 x 2 GR5	2	11	736-0188	Washer, Flat, .760 x 1.49 x .06 Thk.	2
4	712-3054	Nut, Hex Lock, 3/8-24 GR5	2	12	737-3000	Fitting, Lube, 3/16 Drive Type	3
5	712-0431	Nut, Hex Flanged Lock, 3/8-16	2	13	738-3110	Bolt, Pivot Shoulder, 3/4 Dia x 2.23	1
6	712-0711	Nut, Hex Jam, 3/8-24 GR2	4	14	747-3171	Rod, Tie	2
7	712-3004A	Nut, Hex Flange Top Lock, 5/16-18	2	15	748-3049	Arm, Steering	2
8	712-3083	Nut, Hex Top Nylon Lock, 1/2-13	1				

FRONT WHEEL

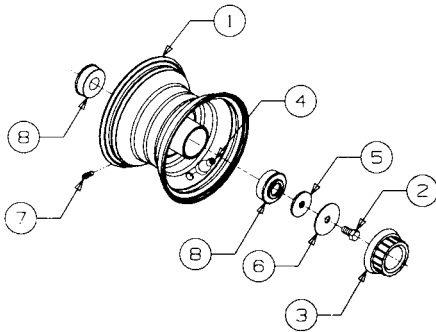

REF. NO.	PART NUMBER	DESCRIPTION	QTY.
	734-3186	Tire, Cub Tread, 15 x 6 x 6	2
1	634-3015	Rim Assy, Front	2
2	710-3119	Bolt, Hex Patch, 3/8-16 x .75 GR5	2
3	731-3020	Cap, Hub	2
4	734-0255	Valve, Tubeless Air	2
5	736-3039	Washer, Flat, .406 x 1.5 x .110	2
6	736-3040	Washer, Flat, .406 x 1.92 x .06	2
7	737-0224	Fitting, Grease	2
8	741-3032	Bearing, Ball	4

REAR WHEEL

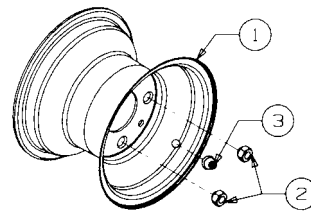

REF. NO.	PART NUMBER	DESCRIPTION	QTY.
	734-3189	Tire, Cub Tread, 20 x 9 x 8	2
1	634-3187	Rim Assy, Rear	2
2	712-3050	Nut, Lug, 7/16-14	8
3	734-0255	Valve, Tubeless Air	2