

## ACCESSORIES

GREASE	17193
KIT- Spike bumper	A-68855
Includes:	
SCREW (2)	80648
NUT (2)	81206
REEL- 250 Ft. starter rope #4	68848
TUBING- Rubber 10 ft.	70309-99
TUBING- Rubber 10 ft.	94772-99
TUBING- Rubber 10 ft.	93112-99
PAINT- Red- 12oz.	23475
CASE- Carrying	94216
DECALS- Set of four	A-69048-A

## TOOLS

TOOL- Check valve	24972
GAUGE- (.015 pink plastic feeler)	22486
LOCTITE	23486-C
PLUG- Needle bearing installation	23756
PULLER- Magneto rotor	A-24544
Includes:	
SCREW- Hex 10-32 x 1 3/8 (4)	82182
WASHER- Flat #10 (4)	84003-1
NUT- Hex centerlock 10-32 (4)	81206
SCREWDRIVER	24541
SHIM (.012 black plastic) Magneto air gap	24306
SPACER- Plug	24548
WRENCH- Spanner (clutch)	A-93791
Includes:	
PIN- Clutch spanner (2)	23717-A
WRENCH- Socket	86651

Ref #	Part Number	Qty	Description
17193	17193		GREASE
A-68655	A-68655		KIT- Spike bumper Includes P/N's 80648 and 81206.
80648	80648		SCREW (2)
81206	81206		NUT (2)
68848	68848		REEL- 250 Ft. starter rope #4
7030999	7030999		TUBING- Rubber 10 ft.
9477299	9477299		TUBING- Rubber 10 ft.
9311299	9311299		TUBING- Rubber 10 ft.
23475	23475		PAINT- Red- 12 oz.
94216	94216		CASE- Carrying
A69048A	A69048A		DECALS- Set of four
24972	24972		TOOL- Check valve
22486	22486		GAUGE- (.015 pink plastic feeler)
23488C	23488C		LOCTITE
23756	23756		PLUG- Needle bearing installation
A-24544	A-24544		PULLER- Magneto rotor Includes P/N's 82162, 840031, & 81206.
82162	82162		SCREW- Hex 10-32 x 1 3/8 (4)
840031	840031		WASHER- Flat #10 (4)
81206	81206		NUT- Hex centerlock 10-32 (4)
24541	24541		SCREWDRIVER
24306	24306		SHIM (.012 black plastic) Magneto air gap
24548	24548		SPACER- Plug
A-93791	A-93791		WRENCH- Spanner (clutch) Includes P/N 23717A.
23717A	23717A		PIN- Clutch spanner (2)
68651	68651		WRENCH- Socket

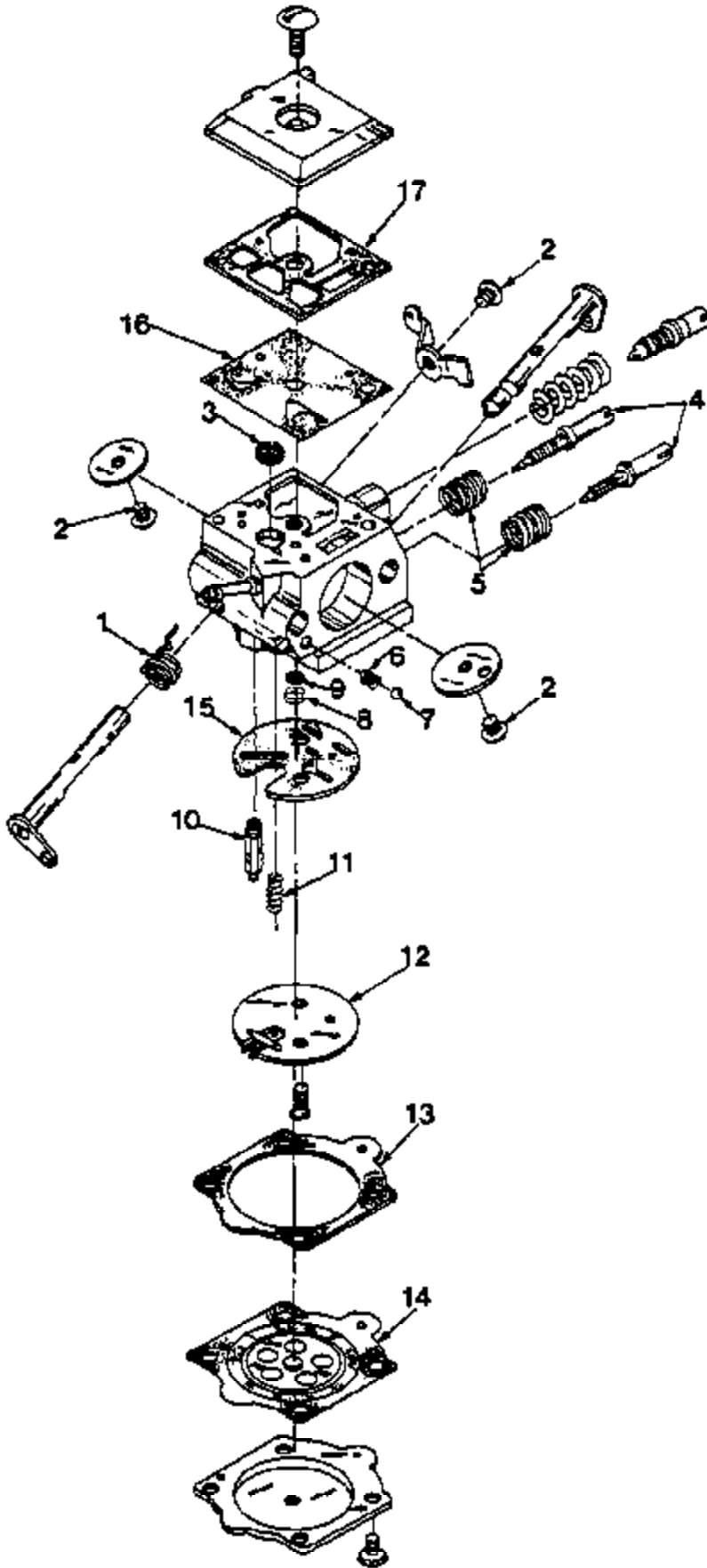

Ref #	Part Number	Qty	Description
1	93200B		Repair Kit Includes Ref. #1 - 17.
2	93200B		Repair Kit Includes Ref. #1 - 17.
3	93200B		Repair Kit Includes Ref. #1 - 17.
4	93200B		Repair Kit Includes Ref. #1 - 17.
5	93200B		Repair Kit Includes Ref. #1 - 17.
6	93200B		Repair Kit Includes Ref. #1 - 17.
7	93200B		Repair Kit Includes Ref. #1 - 17.
8	93200B		Repair Kit Includes Ref. #1 - 17.
9	93200B		Repair Kit Includes Ref. #1 - 17.
10	93200B		Repair Kit Includes Ref. #1 - 17.
11	93200B		Repair Kit Includes Ref. #1 - 17.
12	93200B		Repair Kit Includes Ref. #1 - 17.
13	93200B		Repair Kit Includes Ref. #1 - 17.
	94701		GASKET/Diaphragm Kit Includes Ref. #13 - 17.
14	93200B		Repair Kit Includes Ref. #1 - 17.
	94701		GASKET/Diaphragm Kit Includes Ref. #13 - 17.
15	93200B		Repair Kit Includes Ref. #1 - 17.
	94701		GASKET/Diaphragm Kit Includes Ref. #13 - 17.
16	93200B		Repair Kit Includes Ref. #1 - 17.
	94701		GASKET/Diaphragm Kit Includes Ref. #13 - 17.
17	93200B		Repair Kit Includes Ref. #1 - 17.
	94701		GASKET/Diaphragm Kit Includes Ref. #13 - 17.
	65386		Repair Kit- Check Valve

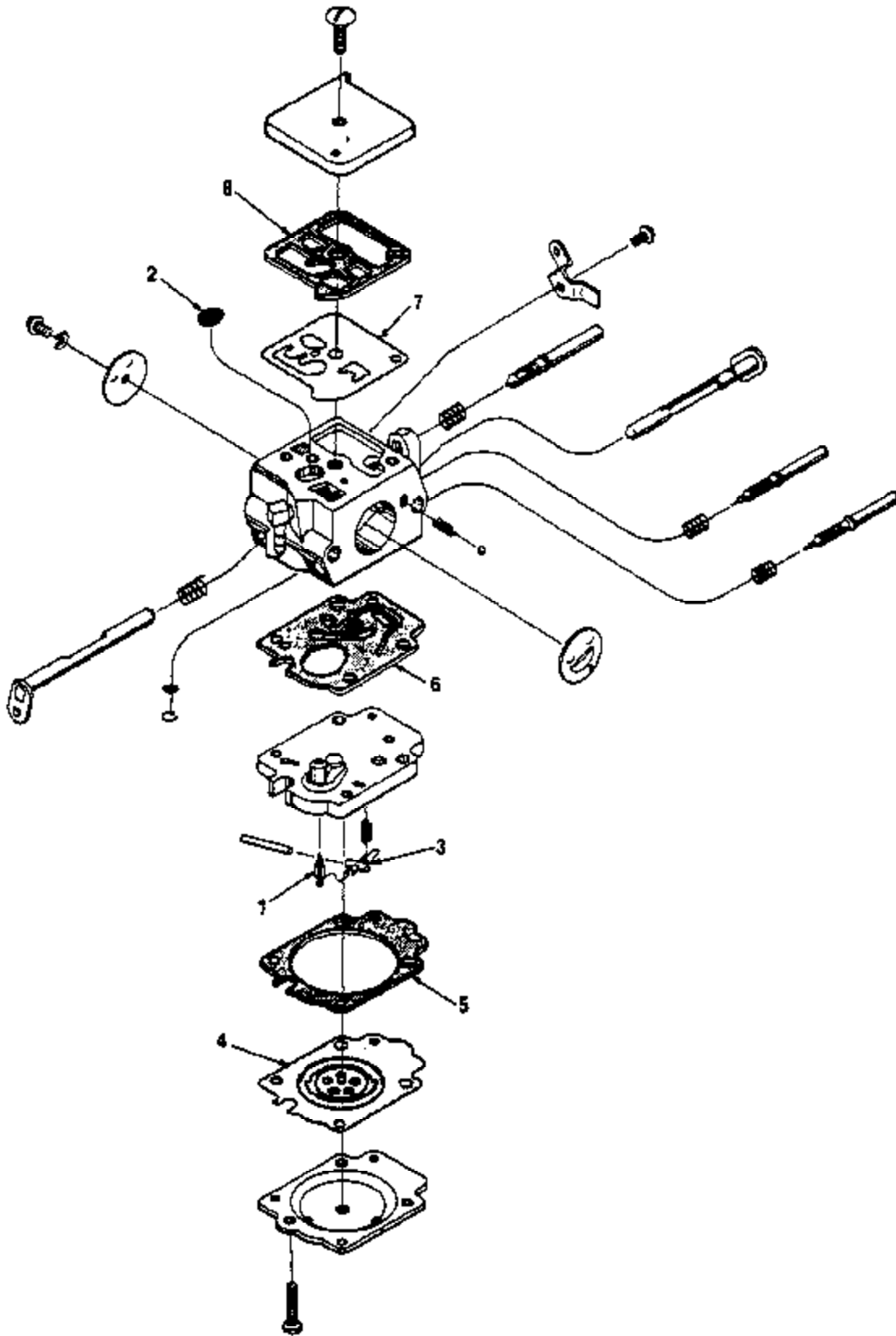

Ref #	Part Number	Qty	Description
1	95697		Repair Kit Includes items 1 - 8.
2	95697		Repair Kit Includes items 1 - 8.
3	95697		Repair Kit Includes items 1 - 8.
4	95697		Repair Kit Includes items 1 - 8.
4	70094		Gasket-Diaphragm Kit Includes items 4 - 8.
5	95697		Repair Kit Includes items 1 - 8.
5	70094		Gasket-Diaphragm Kit Includes items 4 - 8.
6	95697		Repair Kit Includes items 1 - 8.
6	70094		Gasket-Diaphragm Kit Includes items 4 - 8.
7	95697		Repair Kit Includes items 1 - 8.
7	70094		Gasket-Diaphragm Kit Includes items 4 - 8.
8	95697		Repair Kit Includes items 1 - 8.
8	70094		Gasket-Diaphragm Kit Includes items 4 - 8.
	70109		Needle-Inlet

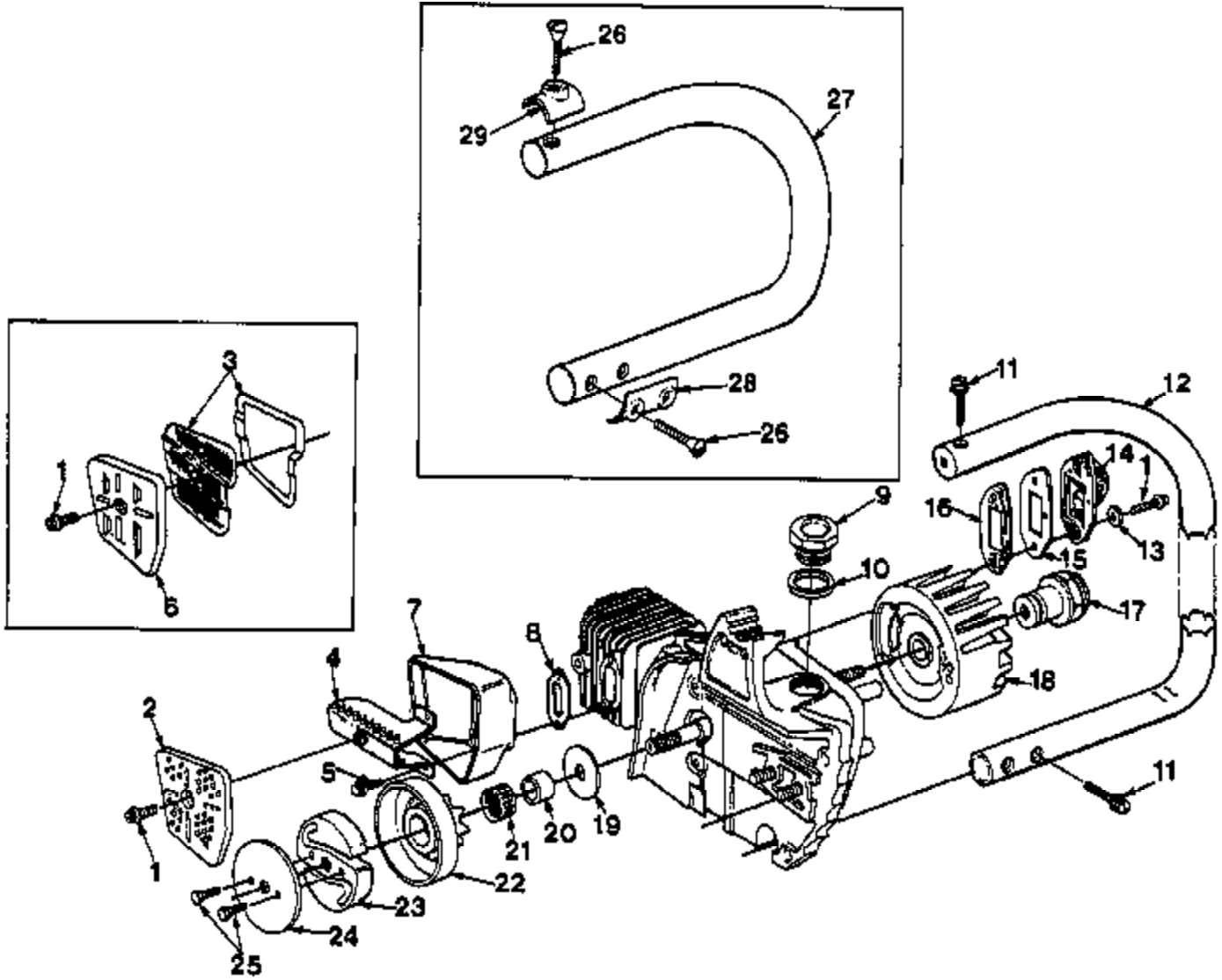

Ref #	Part Number	Qty	Description
1	80983	3	SCREW- Hex washer hd., 8-32 x 1/2
2	685961	1	CAP- Muffler (150 AO)
3	A686661B	1	ARRESTOR- Spark (150 AOW) Included in Muffler temp. kit (150 AOW) P/N A-94068.
4	A68564	1	BAFFLE- Muffler
	A-94068	1	KIT- Muffler temp. (150 AOW) Includes Items 5 - 6.
	A686661B	1	Arrestor Ref. #3
5	80939	4	SCREW- Hex washer hd., 8-32 x 3/8
6	94070	1	CAP- Muffler (150 AOW)
	940711	1	SHIELD (Item 51 in Starter, Tank and Drivecase Cover Diagram)
7	685451	1	BODY- Muffler
8	68542	1	GASKET- Muffler
9	A68557	1	CAP- Oil filler Includes item 10.
10	68533	1	GASKET- Oil filler cap
11	82218	3	SCREW- Oval hd., 10-24 x 1 1/8
12	A709041	1	HANDLE BAR
13	84103	2	WASHER- Flat 7/16 x 3/16 x 1/16
14	A685202	1	MANIFOLD- Intake
15	68671	1	COVER- Pulse
16	68464	1	GASKET- Intake manifold
17	A68610	1	NUT- Rotor Rotor nut A-68610 has left hand threads. Turn nut to the right to remove.
18	68530	1	ROTOR (point ignition) Prior to Lot #D005
18	96891	1	ROTOR (Solid state) After Lot #D005
19	65064	1	WASHER- Thrust
20	65746B	1	RACE- Inner
21	64124	1	BEARING- Needle
22	A95619	1	SPROCKET & DRUM- 7 tooth, 3/8" pitch
	A69953A	1	CLUTCH & PLATE Includes items 23 - 25.
23	683627	1	CLUTCH "S"
24	69915	1	PLATE- Clutch
25	803612	2	SCREW- Hex hd., 10-32 x 1/2
26	82378	2	SCREW- 10-24 x 1 5/8 (150 E)
27	A95291	1	HANDLE BAR (150 E)
28	69301	1	CLAMP- Handle bar (lower)
29	69302	1	CLAMP- Handle bar (upper)



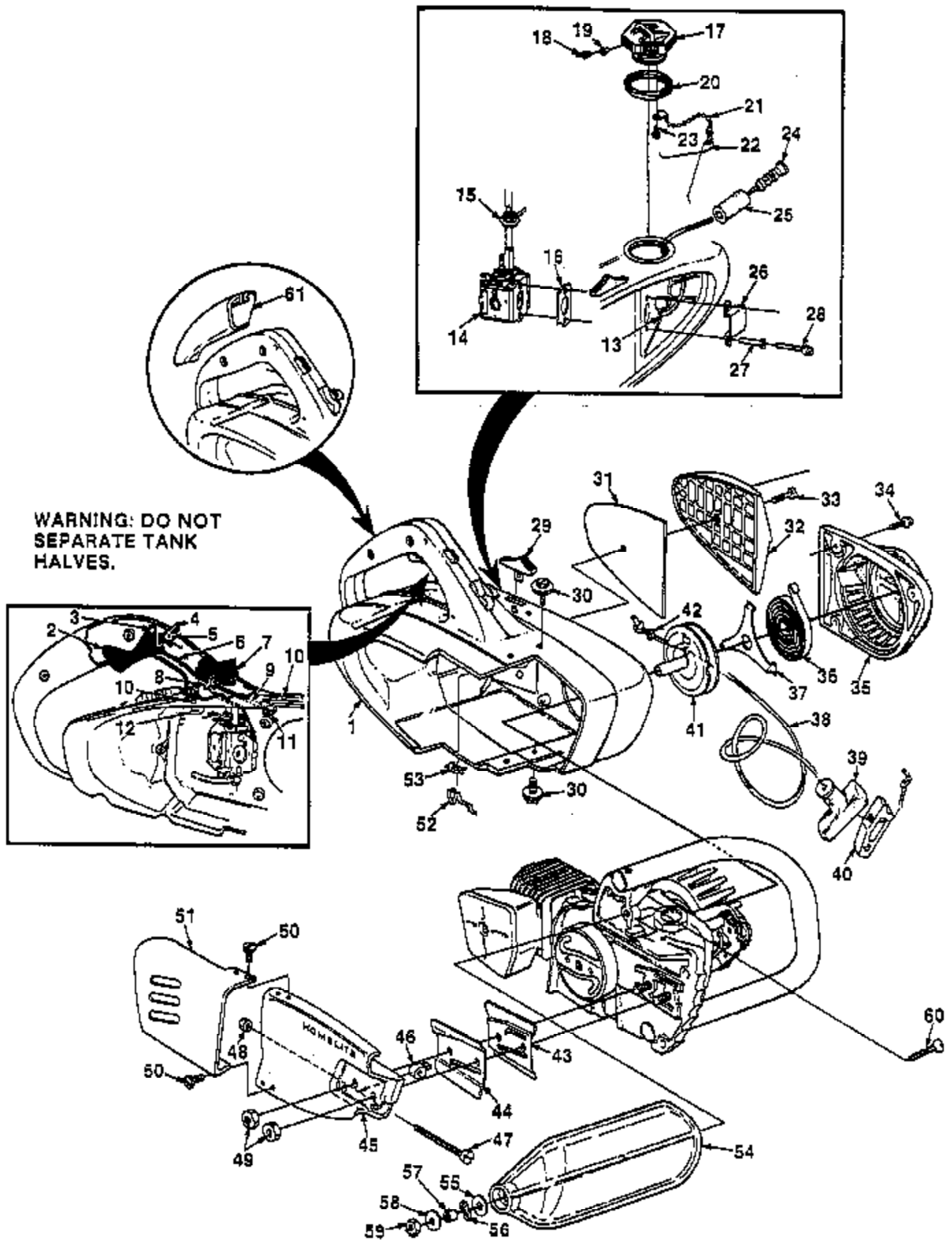

Ref #	Part Number	Qty	Description
1	A686441A	1	ENGINE COVER Includes items 2 - 13.
1	A69549A	1	ENGINE COVER (150-E) Includes items 2 - 13.
2	A-93044	1	TRIGGER- Throttle
3	68548	1	PIN- Trigger
4	68626	1	SPRING- Trigger latch
5	68641	1	PIN- Grooved
6	68550	1	LINKAGE- Throttle
7	68580	1	BUTTON- Stop switch
8	68581	1	SPRING- Stop switch
9	68576	1	LINK- Grounding switch
10	85061	1	RIVET
11	68577	1	CONTACT- Grounding switch
12	68639	1	CLAMP- High tension
13	9477232	1	TUBING- Rubber (fuel) 8"
14	A69957B	1	CARBURETOR- Walbro HDC-54
	A95230A	1	CARBURETOR- Till HK-30 (alternate source)
15	A-70332	1	DETENT- Carburetor
16	68537	1	SPACER- Carburetor
17	A69500A	1	CAP- Fuel filler Includes items 18 - 23.
18	69454	1	FILTER- Fuel cap
19	69451	1	VALVE- Check
20	69501	1	GASKET- Fuel filler cap
21	69502	1	CHAIN- Bead
22	69503	1	RETAINER
23	82256	1	SCREW- Pan hd., #6 x 1/4
24	A-69923	1	FILTER- Fuel
25	64083	1	ELEMENT- Felt filter
26	68534	1	DEFLECTOR- Air
27	68560	1	BUSHING- Flanged
28	82224	2	SCREW- Hex washer hd., 8-32 x 2
29	68551	1	BUTTON- Choke
30	69335A	4	SCREW- Sems hex hd., 10-24 x 5/8
31	68532	1	FILTER- Element air
32	68531A	1	COVER- Air filter
33	68535	1	SCREW- Cover retaining
34	80983	2	SCREW- Hex washer hd., 8-32 x 1/2
	A68611A	1	STARTER- Complete Includes items 35 - 41.
35	A68523A	1	HOUSING- Starter
36	65107	1	SPRING- Rewind
37	68612	1	RETAINER- Rewind spring
38	A-93876	1	ROPE- Starter #4 (42" long)
39	A69962B	1	GRIP- Starter rope
40	70018A	1	INSERT- Rope retaining
41	A68645A	1	PULLEY- Starter Includes item 42.
42	93862	1	WASHER- Nylon
43	67300C	1	PLATE- Guide bar (inner)
44	67299C	1	PLATE- Guide bar (outer)
45	A686141A	1	COVER- Drivecase Includes items 46 - 48.
46	651121	1	PIN- Guide bar adjusting
47	65175A	1	SCREW- Guide bar adjusting
48	81206	1	NUT- Hex centerlock, 10-32
49	81196	2	NUT- Hex 5/16-18
50	80939	2	SCREW- Pan hd., 8-32 x 3/8 (150 AOW)
51	940711	1	SHIELD MUFFLER- (150 AOW) Included in Muffler temp. kit (150 AOW) P/N A-94068.
52	68552	1	ROD- Choke
53	68584A	1	SPRING- Choke

Ref #	Part Number	Qty	Description
54	A-95088	1	HANDGUARD
55	95935	1	WASHER
56	96757	1	WASHER
57	95937	1	SPACER
58	840651	1	WASHER
59	81225	1	NUT- Hex (12-24)
60	80945	1	SCREW- Flat head
61	69303	1	COVER- Right hand (150-E)

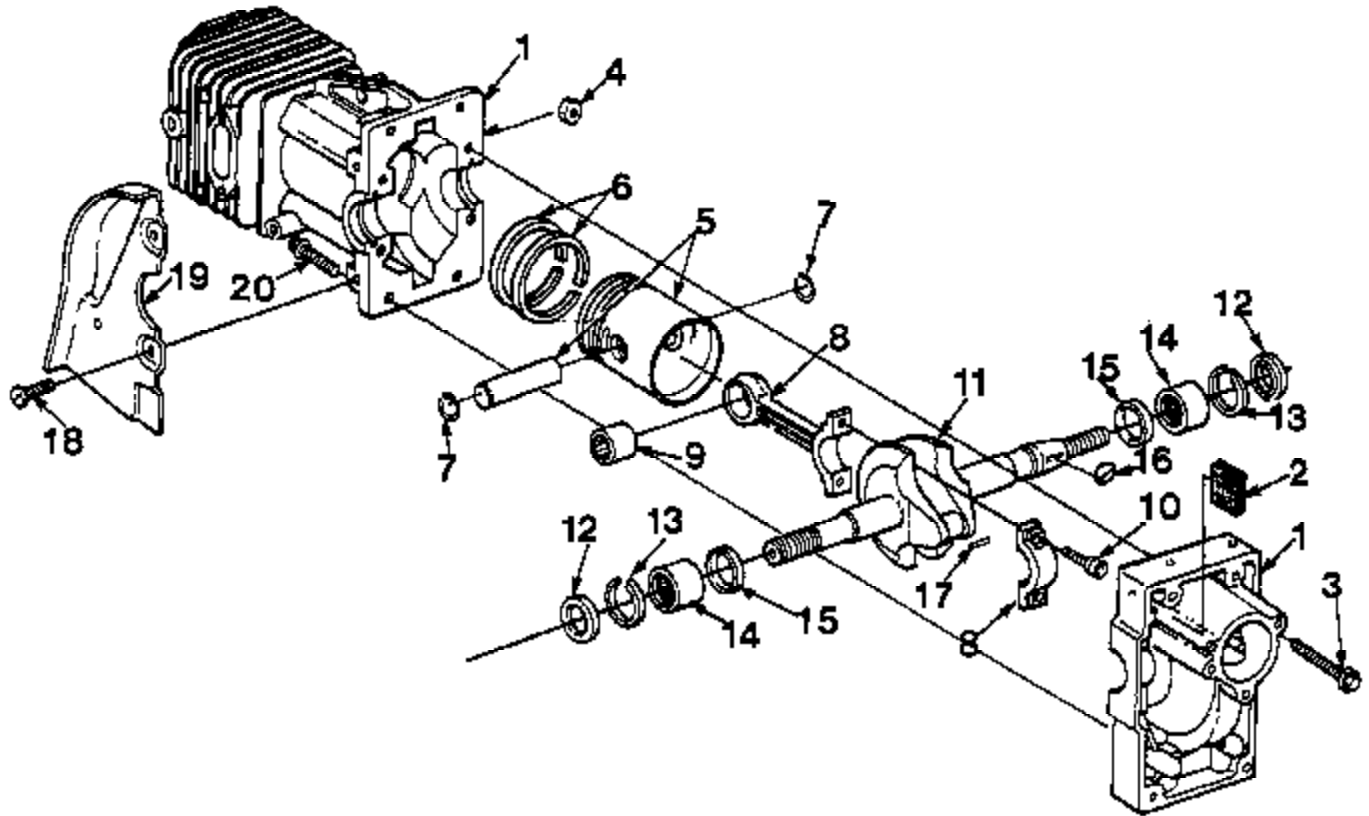

Ref #	Part Number	Qty	Description
1	A68643D	1	CRANKCASE & CYLINDER Includes items 2 - 4.
2	68990A	1	COVER- Vent
3	88044	4	SCREW- Hex washer hd. 8-32 x 1
4	81223	4	NUT- Hex centerlock 8-32
	68623	1	CLAMP (not shown)
	643091	1	PIN- Dowel (not shown)
	80571	2	SCREW- Pan washer hd. 6-32 x 3/8 (not shown)
5	A68642	1	PISTON & PIN Includes items 6 - 10.
6	68508	2	PISTON- Ring
7	64813	2	RING- Piston retaining
8	A68518	1	ROD- Connecting Includes items 9 - 10.
9	68512	1	BEARING- Needle
10	69919	2	SCREW- Soc. hd., 8-32 x 1/2
11	685071	1	CRANKSHAFT
12	94638	2	SEAL
13	68514	2	RING- Retaining
14	12530	2	BEARING- Roller
15	68509A	2	BEARING- Thrust
16	65126	1	KEY- Woodruff
17	A68511	1	ROLLER- Needle (set of 18)
18	95922	3	SCREW- Pan taptite 8-32 x 5/16
19	68596	1	SHIELD- Sawdust
20	82248	4	SCREW- Hex hd. 8-32 x 3/4



Ref #	Part Number	Qty	Description
1	68616S	1	SPARK PLUG
2	A33055	1	TERMINAL- Spark plug
3	88045	4	SCREW- Hex washer hd. 8-32 x 1.25
4	A69341	1	BUSHING & TERMINAL
5	68990A	1	COVER- Vent
6	68623	1	CLAMP- High tension lead
7	A70974A	1	PUMP- Automatic oil Includes items 8 - 15.
8	A68583B	1	PLUNGER- Oil pump
9	82291	2	SCREW- 8-32 x .625
10	A68593	1	FILTER- Oil
11	7030909	1	LINE- Oil pick-up 2 1/4"
12	70204	1	FITTING- Tube
13	60051	1	BALL- Check friction
14	68570	1	SPRING- Choke valve
15	94619	1	FITTING- Tube
16	68589C	1	GASKET- Oil tank
17	81208	1	NUT- Hex centerlock 10-24
18	9311219	1	RUBBER- Tubing 4 3/4
19	A937431A	1	TANK- Oil Includes items 20 - 21.
20	58753	2	BOLT- Guide bar
21	70972	1	FITTING- Tube
22	A97026	1	KIT- Ignition conversion Includes items 23 - 25.
23	84101	2	WASHER- Flat
24	82248	2	SCREW- Mach
25	96907	1	SLEEVE- Insulating
26	68625	1	SLEEVE- Wire (fiberglass)
27	82256	2	SCREW- Pan hd., plastite (6 x 1/4)
28	A93626	1	LEAD- Stop switch
29	A69533A	1	BOX- Breaker Includes items 30 - 32.
30	82256	1	SCREW- Plastite #6 x 1/4
31	A94631	1	POINTS- Breaker
32	A94231	1	COVER- Breaker box Includes item 33.
33	68618A	1	SEAL- Breaker box cover
34	80571	2	SCREW- Pan washer hd., 6-32 x 3/8
35	84025	2	WASHER- Flat #8
36	93849	1	SEAL
37	A68649A	1	COIL- Ignition Includes item 38.
38	68629	1	LEAD- Hi-tension
39	A68648	1	CORE Includes Retainer Coil.
	68257	1	RETAINER- Coil Included in item 39 (not shown)
40	82248	2	SCREW- Hex hd. 8-32 x 3/4
41	68543	1	CONDENSER
42	68613	1	BLOCK- Terminal