

Ref #	Part Number	Qty	Description
1	93205A	1	Repair Kit
2	93205A	1	Repair Kit
3	93205A	1	Repair Kit
4	93205A	1	Repair Kit
5	93205A	1	Repair Kit
6	93205A	1	Repair Kit
7	93205A	1	Repair Kit
8	93205A	1	Repair Kit
9	93205A	1	Repair Kit
10	93205A	1	Repair Kit
11	93205A	1	Repair Kit
12	93205A	1	Repair Kit
13	93205A	1	Repair Kit
	93754	1	Gasket/Diaphragm Kit
14	93205A	1	Repair Kit
	93754	1	Gasket/Diaphragm Kit
15	93205A	1	Repair Kit
	93754	1	Gasket/Diaphragm Kit
16	93205A	1	Repair Kit
	93754	1	Gasket/Diaphragm Kit
17	93205A	1	Repair Kit
	93754	1	Gasket/Diaphragm Kit
18	93910A	1	Check Valve Repair Kit

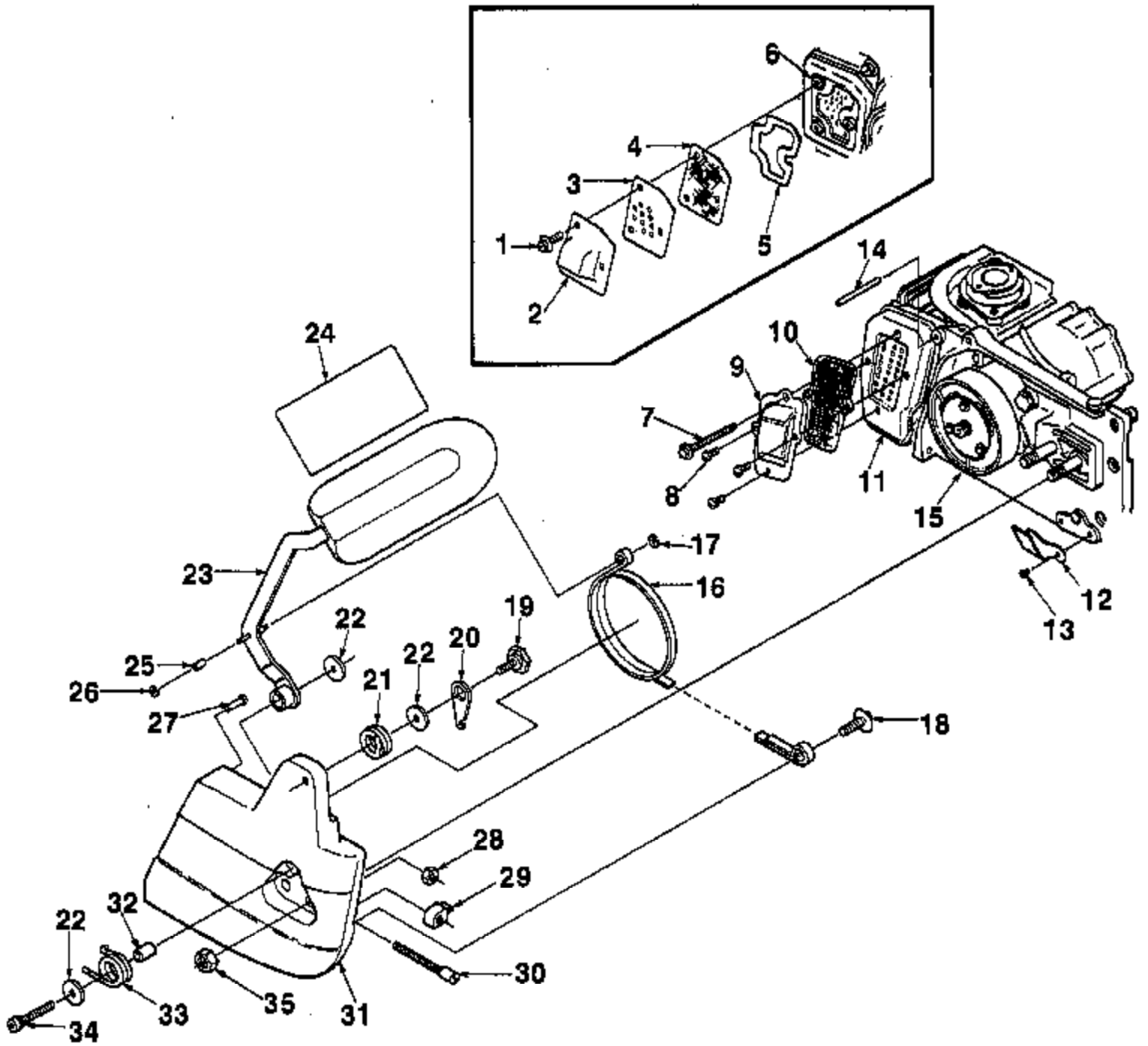

Ref #	Part Number	Qty	Description
1	88041	3	SCREW- Hex sems, 8-32 x 3/8 (prior to lot #C-320)
2	121951	1	PLATE- Muffler exhaust (prior to lot #C-320)
3	12119	1	BAFFLE (prior to lot#C-320)
4	D12270B	1	ARRESTOR- Spark (accessory) prior to lot #C-320)
5	12173	1	GASKET- Exhaust plate (prior to lot #C-320)
6	A12265	1	MUFFLER (prior to lot #C-320)
	12080A	1	GASKET- Muffler (shown on Fig. 2) (prior to lot #C-320)
7	93460	1	SCREW (After lot #C-320)
8	82370	3	SCREW (After lot #C-320)
9	947951	1	PLATE- Exhaust (After lot #C-320)
10	94797	1	SCREEN- Spark arrestor (Opt.) (After lot #C-320)
11	947851	1	MUFFLER (After lot #C-320)
12	70705	1	STOP- Chain
13	88042	1	SCREW- Hex hd. sems 8-32 x 1/2
	A93693A	1	KIT- Chain brake
14	64870	1	PIN- Dowel (125 x 1 3/8)
15	A936302	1	DRUM & HUB
16	A94561	1	BRAKEBAND
17	69599	1	"E" RING
18	82258	1	SCREW- Pan hd. 1/4-20 x 5/8
19	93773	1	SCREW- Shoulder
20	93602A	1	LEVER- Locking
21	93600B	1	SPRING- Locking lever
22	93282	3	WASHER
23	A97221A	1	LEVER- Brake w/guard
24	02661	1	DECAL
25	93625	1	BEARING- Roller
26	70925	1	"E" RING
27	70313	1	SLEEVE- Headed
28	81206	1	NUT- Centerlock
29	651121	1	PIN- Guide bar adjusting
30	93962	1	SCREW- Guide bar adjusting
31	A04241	1	COVER- Drivecase
32	93296	1	SLEEVE- Lever
33	93603	1	SPRING- Brake lever
34	804281	1	SCREW- Soc cap hd.
35	81196	2	NUT- Hex 5/16-18

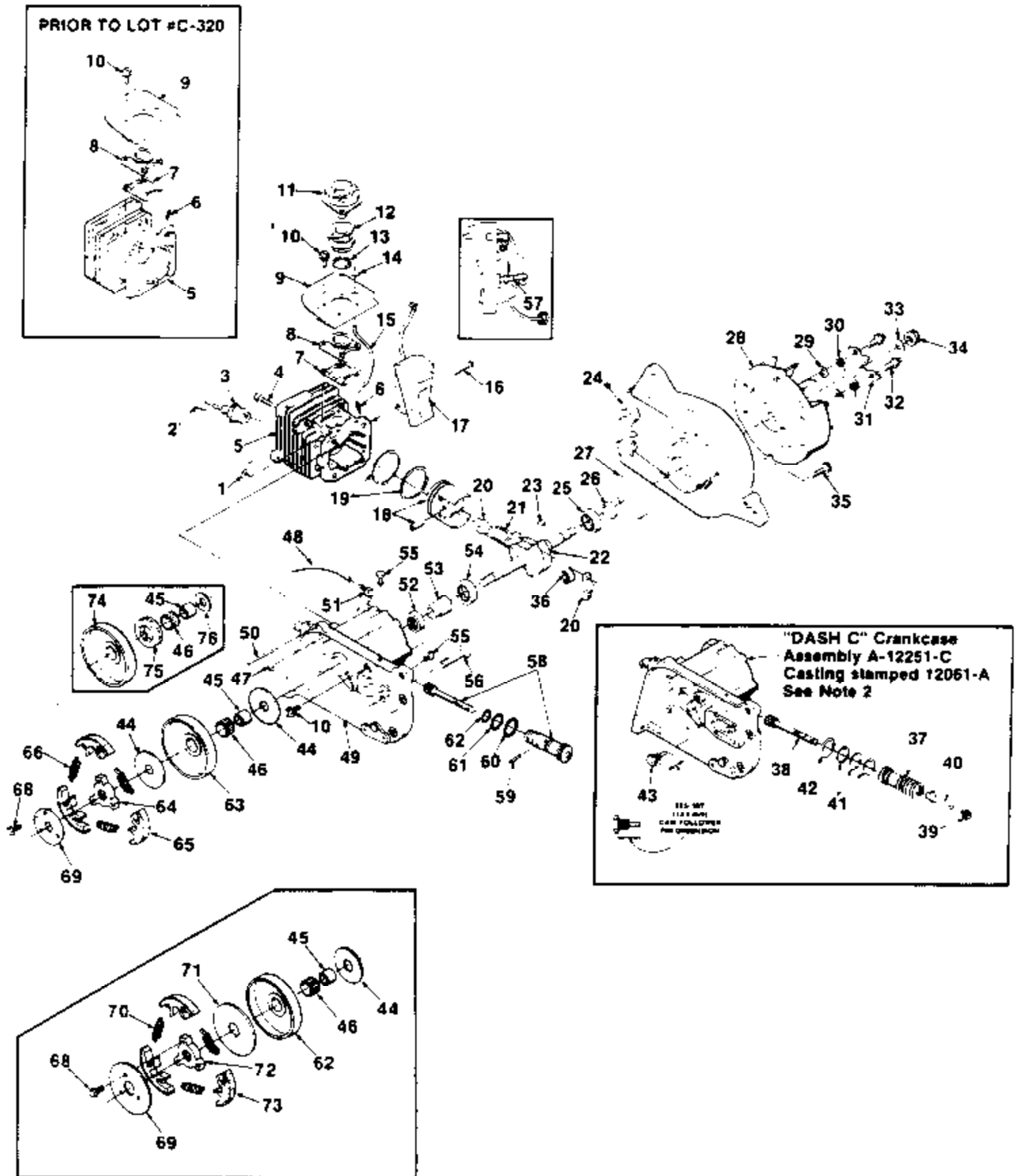

Ref #	Part Number	Qty	Description
1	12021	4	WASHER
2	12191	1	GROMMET- Spark plug
3	63547S	1	SPARK PLUG (Champ CJ6)
4	82262	4	SCREW- Soc. hd. cap #10-24 x 7/8
5	A70716A	1	CYLINDER (Prior to lot #C-320)
	A94781	1	CYLINDER (After lot #C-320)
6	69833	1	FITTING
7	70714	1	GASKET- Intake adapter
8	70715	1	MANIFOLD- Intake
9	121611B	1	DEFLECTOR- Air (Intake)
10	88042	5	SCREW- Hex hd. w/washer 8-32 x 1/2
11	A70246B	1	FLANGE- Carburetor connector
12	12048C	1	CONNECTOR- Carburetor
13	12291	1	SPRING- Garter
14	62740	1	GROMMET
15	9311222	1	LINE- Pulse 5 1/2"
16	88045	2	SCREW- Hex sems 8-32 x 1 1/4
17	12669A	1	MODULE & CORE
18	A12257A	1	PISTON & PIN
19	12040	2	PISTON RING
20	A120681	1	ROD- Connecting
21	69919	2	SCREW- Soc. hd. 80-32 x 9/16
22	120371	1	CRANKSHAFT
23	75078	1	KEY- Woodruff
24	A12204A	1	PLATE- Back
25	63867	1	BEARING- Roller
26	12282A	1	SEAL
27	58785	1	O" RING
28	12101A	1	ROTOR
29	83046	2	WASHER- Lock #10
30	12055	2	SPRING- Starter pawl
31	12056	2	PAWL- Starter
32	65109	2	STUD- Starter pawl
33	95479A	1	WASHER- 3/8"
34	81255	1	NUT- 3/8 - 24
35	88051	5	SCREW- Hex sems 10-24 x 3/4
36	A12913	1	ROLLERS- Needle (Set of 25)
37	A12201A	1	PUMP- Automatic Oil
38	A12202	1	PLUNGER- Oil pump
39	88041	1	SCREW- Hex sems 8-32 x 3/8
40	12141	1	LEVER- Oil Adjustment
41	12095	3	"O" RING
42	12155	1	"O" RING
43	A12144	1	PIN & PLUG
44	63860	2	WASHER- Thrust
45	65985B	1	RACE- Inner
46	64124	1	BEARING- Needle
47	81208	4	NUT- Centerlock #10-24
48	9311219	1	TUBING-Rubber (Oil) 4 3/4"
49	A12251E	1	CRANKCASE
50		1	PIN- Dowel (.125 x 1.375) Install in crankcase for chain brake only Pin #14 supplied loose in SL chain brake kit and 360 service crankcase assy, not available separately. For chain brake mounting only, press pin into hole provided in crankcase boss until there is .375 (.095 MM) remaining for engagement of pin in chainbrake drivecase cover, pin is required only for c

Ref #	Part Number	Qty	Description
51	50558	1	FITTING- Oil line
52	70729	1	SEAL- (Double lips)
53	12071	1	WORM- Gear
54	63867	1	BEARING- Roller
55	12096	2	BUMPER
56	58753	2	BOLT- Guide bar 5/16"
57	12298	1	CABLE TIE- Module lead
58	A70962	1	PUMP- Automatic Oil
59	70920	1	PIN- Pump
60	70921	1	"O" RING
61	12853	1	"O" RING
62	12095	1	"O" RING
63	A95465	1	SPROCKET & DRUM 7T, 3/8 P
	A93867A	1	KIT- Clutch conversion
64	96448	1	SPIDER Clutch (After lot #C-320)
65	A96447A	3	SHOE- Clutch (After lot #C-320)
66	96451	3	SPRING- Extension (After lot #C-320)
	96449	1	COVER- Clutch (After lot #C-320)
68	88041	1	SCREW- Hex sems 8-32 x .375
69	93628	1	COVER- Clutch (Prior to lot #C-320)
70	93638A	3	SPRING- Clutch (Prior to lot #C-320)
71	93643	1	WASHER- Thrust (Prior to lot #C-320)
72	93636	1	SPIDER- Clutch (Prior to lot #C-320)
73	A93632B	3	SHOE- Clutch (Prior to Lot #C-320)
74	A94302	1	DRUM & HUB
75	95058A	1	SPROCKET & RIM 7T 3/8 P (Primary source)
76	588331	1	WASHER- Thrust (Inner) (Prior to Lot #C-320)

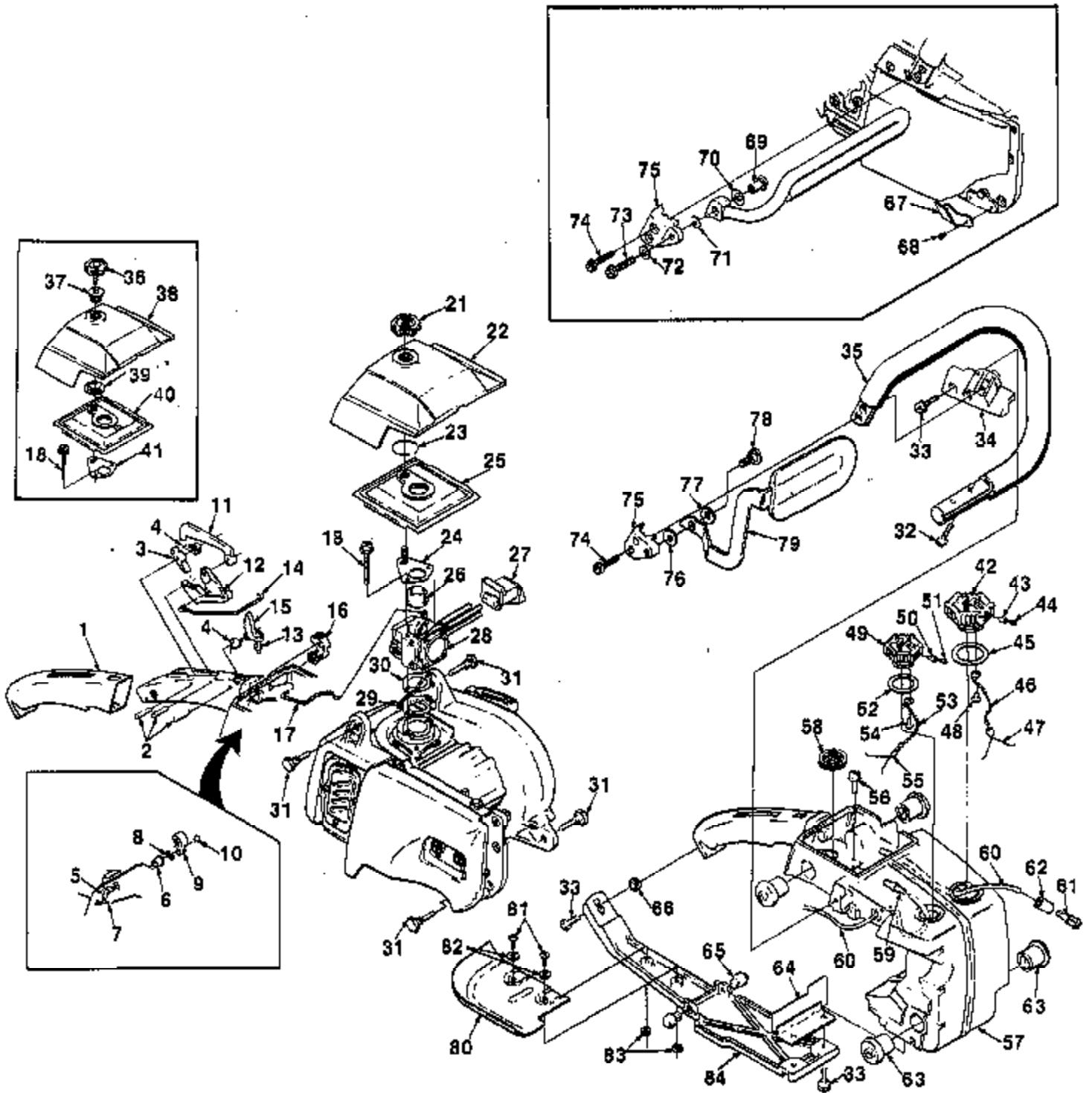

Used with A-12286 housing
with threaded hole.

Ref #	Part Number	Qty	Description
1	12049	1	GRIP- Throttle handle
2	70253	3	PIN- Dowel
3	12092	1	LEVER- Trigger lock
4	12051	2	SPRING- Torsion
5	A12227	1	SHAFT- Choke (prior to lot # 1054)
6	12147	1	BUSHING (prior to lot #1054)
7	12149A	1	ROD- Choke (prior to lot #1054)
8	12150	1	WASHER- Wave (prior to lot #1054)
9	12145	1	KNOB- Choke (prior to lot #1054)
10	88042	1	SCREW- 8-32 x 1/2 (prior to lot #1054)
11	12093	1	LOCK- Trigger
12	A12966	1	KIT- Trigger & Screw
13	120941A	1	SCREW- Trigger latch
14	120781A	1	ROD- Throttle
15	120911A	1	LATCH- Trigger
16	94765	1	KNOB- Choke (After lot #1054)
17	94977	1	ROD- Choke (After lot #1054)
18	93460	2	SCREW- Hex sems 10-24 x 1.75
19	9311219	2	TUBING- Rubber (oil) 4 3/4"
20	12135	1	FITTING- Oil line
	A94055A	1	KIT- Air filter cover
21	A676392	1	NUT- Filter cover mtg.
22	120332A	1	COVER- Filter
23	58319A	1	RING- Retaining
24	A93240	1	BRACKET- Mounting cover
25	A122251	1	FILTER- Air
26	121091	1	BUSHING- Flange
27	12054	1	GROMMET- HI-LOW
28	A97801	1	CARBURETOR- (HDC-39-A)
29	A70923A	1	BUSHING
30	70743A	1	GASKET
	A70624A	1	SET- Isolator pin
31	12100B	4	PIN- Isolator
32	82262	4	SCREW- Soc. hd. 10-24 x 7/8
33	88051	3	SCREW- Hex sems 10-24 x 3/4
34	120592A	1	BRACKET- Handle bar
35	A12107A	1	HANDLE BAR
36	A12112	1	NUT- Filter cover mounting
37	12110	1	BUSHING- Nylon
38	A94055A	1	COVER- Air filter
39	12140	1	NUT- Push on spring
40	A12225	1	FILTER- Element air
41	121171	1	PLATE- Spring
42	A69500A	1	CAP- Fuel filler
43	69451	1	VALVE- Check (oval duckbill)
44	69454	1	FILTER- Filler cap
45	69501	1	GASKET- Fuel cap
46	69502	1	CHAIN- Bead
47	96535	1	RETAINER
48	82256A	1	SCREW- Pan hd. plastite 6 x 1/4
49	A12222	1	CAP- Oil filler
50	69451	1	VALVE- Check (oval duckbill)
51	69454	1	FILTER- Filler cap
52	12126	1	GASKET- Oil cap
53	69502	1	CHAIN- Bead
54	82256A	1	SCREW- Pan hd. plastite 6 x 1/4
55	96535	1	RETAINER- Cap
56	88050	2	SCREW- Hex sems 10-24 x 5/16

Ref #	Part Number	Qty	Description
57	A12286B	1	HOUSING- Engine
58	12269	1	SCREEN- Air inlet
59	A59009A	1	FINDER- Oil
60	9311242	2	TUBING- Rubber (Fuel) 10 1/2"
61	A69923	1	PICK-UP- Fuel
62	64083	1	FILTER- Felt
63	A70623	1	SET- Isolator- soft (set of four)
	A70622	1	SET- Isolator-hard (set of four) (Alternate)
64	A12153	1	DEFLECTOR- Air (exhaust)
65	12096	2	BUMPER
66	70810	1	NUT- Hex 10-24
	A93967A	1	KIT- Hand guard
67	70705	1	STOP- Chain
68	88042	2	SCREW- Hex sems 8-32
69	12240	1	SPACER- Nut (prior to lot #9240)
70	12239	1	WASHER- Cupped spring (prior to lot #9240)
71	83056	1	WASHER (prior to lot #9240)
72	12296	1	WASHER (prior to lot #9240)
73	88054	1	SCREW- Hex sems 10-24 x 1 1/4 (prior to lot #9240)
74	88055	1	SCREW- Hex sems 10-24 x 1 3/8
75	122383	1	BRACKET- Hand guard
76	94867	1	WASHER
77	70788	1	WASHER- Belleville
78	93914	1	SCREW- Shoulder
79	A93968A	1	GUARD- Hand
80	A12267B	1	KIT- Right hand guard
81	82275	2	SCREW- Hex hd. cap
82	84003	2	WASHER
83	81208	2	NUT- Center lock #10-24
84	120422	1	BRACE- Handle

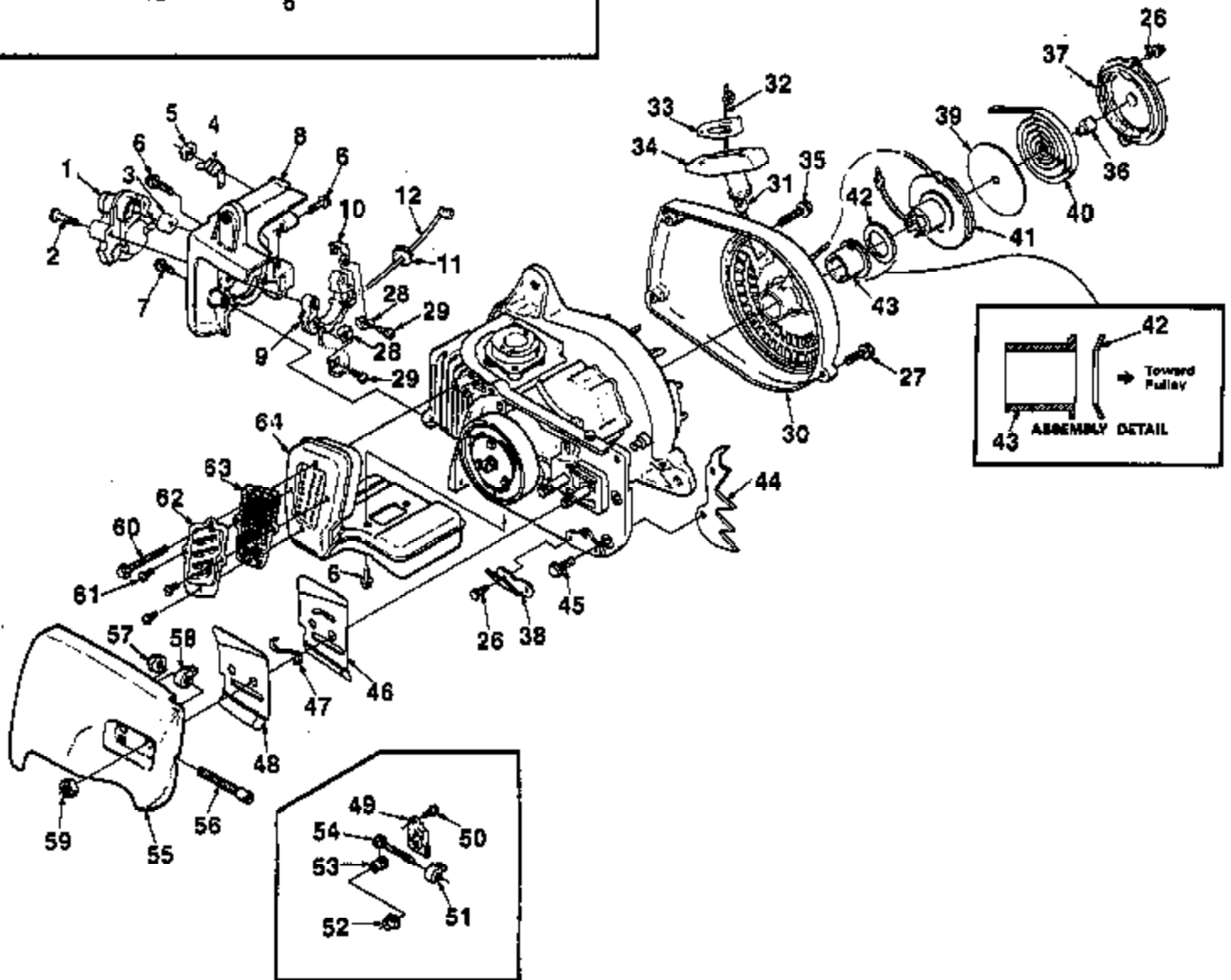
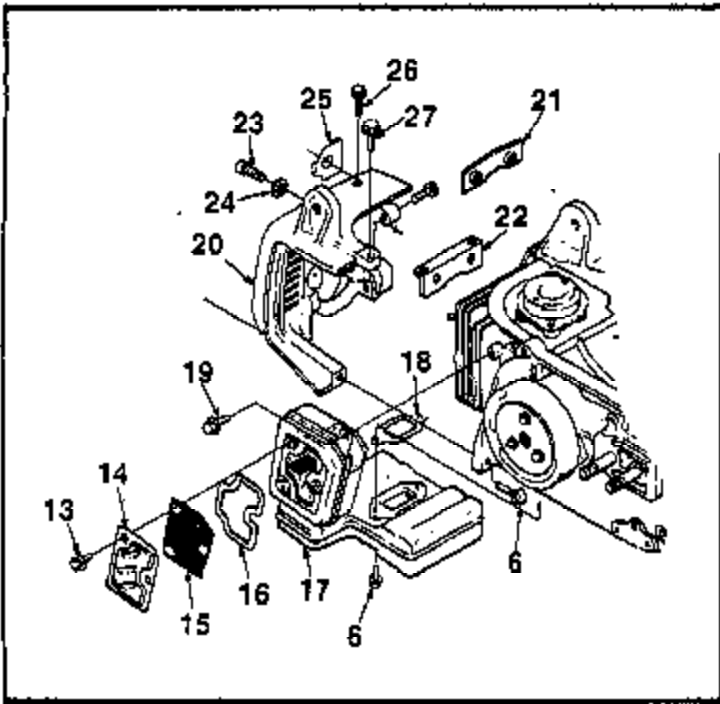

Ref #	Part Number	Qty	Description
1	A12299A	1	TRANSFORMER
2	95270	2	SCREW
3	12191	1	GROMMET
4	A576503A	1	SWITCH- Grounding
5	72084A1	1	NUT
6	88051	4	SCREW- Hex sems 10-24 x 3/4
7	88054	3	SCREW- 10-24 x 1 1/4 (after lot #C-320)
8	947792	1	SHIELD- Cylinder (after lot #C-320)
9	A70088	1	RECEPTACLE- Transformer
10	70720	1	CONTACT- Ground
11	68279	1	GROMMET
12	A12719B	1	LEAD- Low tension
13	88041	3	SCREW- Hex sems 8-32 x 3/8 (Prior to lot #C-320)
14	121761	1	PLATE- Exhaust (W) (prior to lot #C-320)
15	D12270B	1	SPARK ARRESTOR (Accessory) (prior to lot #C-320)
16	12173	1	GASKET- Exhaust plate (prior to lot #C-320)
17	A70784	1	MUFFLER- 360 AO (prior to lot #C-320)
18	12080A	1	GASKET- Muffler
19	88049	1	SCREW- Hex sems 10-24 x 1/2 (prior to lot #C-320)
20	A93128A	1	SHIELD- Cylinder (prior to lot #C-320)
21	93075	1	PLATE- Nut (prior to lot #C-320)
22	93063	1	BRACKET- Cylinder (prior to lot #C-320)
23	69919	2	SCREW (prior to lot #C-320)
24	12071	2	WASHER (prior to lot #C-320)
25	12793A	1	PLATE- (Run - Stop) (prior to lot #C-320)
26	88042	2	SCREW- Hex hd. w/washer 8-32 x 1/2
27	88053	2	SCREW- 10-24 x 1" hex sems
28	12788	2	CONTACT- Transformer
29	82215	2	SCREW- Plastite pan 6 x 3/8
30	A12114A	1	HOUSING- Rewind starter
31	65185	1	BUSHING- Rope
32	94564	1	ROPE- Starter (38" #4)
33	70018A	1	INSERT- Rope retaining
34	A69962B	1	GRIP- Starter rope
35	88055	1	SCREW- Hex sems 10-24 x 1 3/8
36	65102	1	LOCK- Spring
37	12523	1	COVER- Starter
38	70705	1	STOP- Chain
39	12052	1	SPRING- Shield
40	65107	1	SPRING- Rewind
41	A12214A	1	PULLEY & CUP
42	70842	1	WASHER- Spring
43	12053	1	BUSHING- Starter
44	A12272C	1	BUMPER- Spiked (accessory)
45	88048	2	SCREW- Hex hd. 10-24 x 3/8
46	70397	1	PLATE- Guide bar (Inner)
47	69966	1	SPRING- Guide bar
48	70398	1	PLATE- Guide bar (Outer)
49	12134	1	COVER- Gear
50	82251	2	SCREW- Pan hd. mach 6-32 x 3/8
51	651121	1	PIN-Guidebar adjusting
52	70693	1	BUSHING
53	A70694	1	ADJUSTER- Guide bar
54	A12132	1	SCREW-Guidebar adjusting
55	A939302	1	COVER- Drivecase
56	93962	1	SCREW- Guide bar adjusting
57	81206	1	NUT- Centerlock (10-32)
58	651121	1	PIN-Guidebar adjusting

Ref #	Part Number	Qty	Description
59	81196	2	NUT-Hex 5/16-18
60	93460	1	SCREW (After lot #C-320)
61	82370	3	SCREW- (After lot #C-320)
62	947961	1	PLATE- Exhaust (After lot #C-320)
63	94797	1	SPARK ARRESTOR SCREEN (Opt.) (After lot #C-320)
64	A947851	1	MUFFLER (After lot #C-320)

TOOLS

ANVIL- Bearing removal (crankcase)	23848-1
ANVIL- Bearing removal (Crankcase & Backplate)	23848-2
KEY- Hex 5/32 (Cyl. & Handle bar)	22128
KEY- Hex 9/64 (HG-SL)	23528
PULLER- Rotor	A-24290
Includes:	
SCREW- Rotor removal	24301
RING- Retaining	87912
SHIM- Yellow plastic (.020) (air gap)	24853
SLEEVE- Seal assembly (Crankcase & Backplate)	23759
SLEEVE- Seal removal (Crankcase)	23138-8
TOOL & PLUNGER- Piston pin	A-24871
Wrench- Socket	88851
WRENCH- Spanner ("S" Clutch)	A-93791
Includes:	
PIN	23717-A
SCREW DRIVER	24541
CLUTCH TOOL- (3 shoe-clutch)	A-17146
GREASE- Multi use	17193

ACCESSORIES

ADHESIVE- Zip grip	70627
BUMPER- Spiked	DA-12272-E
EXCHANGER- Heat	A-94284-B
KIT- Chain brake	A-93893-A
KIT- Hand guard	A-93967-A
SAFE-T-TIP (STD)	A-70790-B
KIT- Guide bar insert	A-98812
KIT- Sprocket repair	A-88498-B
RUBBER- Tubing 10'	93112-99
ROPE- Starter #4 250 FT. reel	88848
SET- Isolator- hard (set of four)	A-70622
SPRAY CAN- Red	23475

NOTE: Alignment plug required for A-12201-A oil pump only.

BAR & CHAIN COMBINATIONS

BAR LENGTH & TYPE	BAR NUMBER	CHAIN DESCRIPTION	CHAIN NO. (BLISTER PACK)	CHAIN NO. (BOXED)
18" PT GW SP	PT-18381-G5	38-ME50-89	D-92428-A	J1-92059-LB
	GW-18001-G5	38-ME50-89		
	SP-18381-H5	38-ME50-89		
20" PT GW SP	PT-20381-G5	38-ME50-70	D-92431-A	J1-92070-LB
	GW-20001-G5	38-ME50-70		
	SP-20381-H5	38-ME50-70		
24" PT GW SP	PT-24381-G5	38-ME50-81	D-92432-A	J1-92081-LB
	GW-24001-G5	38-ME50-81		
	SP-24381-H5	38-ME50-81		

Ref #	Part Number	Qty	Description
PT-16381-G5	PT16381G5	1	16" PT
GW-16001-G5	GW16001G5	1	16" GW
SP-16381-H5	SP16381HG	1	16" SP
PT-20381-G5	PT20381G5	1	20" PT
GW-20001-G5	GW20001G5	1	20" GW
SP-20381-H5	SP20381H5	1	20" SP
PT-24381-G5	PT24381G5	1	24" PT
GW-24001-G5	GW24001G5	1	24" GW
SP-24381-H5	SP24381H5	1	24" SP
D-92428-A	D92428A	1	38-ME5-59
D-92431-A	D92431A	1	38-ME5-70
D-92432-A	D92432A	1	38-ME5-81
J1-92059-LB	J192059LB	1	38-ME5-59
J1-92070-LB	J192070LB	1	38-ME5-70
J1-92081-LB	J192081LB	1	38-ME5-81
23846-1	238461	1	ANVIL- Bearing removal (crankcase)
23846-2	238462	1	ANVIL- Bearing removal (crankcase & Backplate)
22126	22126	1	KEY- Hex 5/32 (Cyl. & Handle bar)
23528	23528	1	KEY- Hex 9/64 (HG-SL)
A-24290	A24290	1	PULLER- Rotor
24301	24301	1	SCREW- Rotor removal
67912	67912	1	RING- Retaining
24853	24853	1	SHIM- Yellow plastic (.020) (air gap)
23759	23759	1	SLEEVE- Seal assembly (Crankcase & Backplate)
23136-6	231366	1	SLEEVE- Seal removal (Crankcase)
A-24871	A24871	1	TOOL & PLUNGER- Piston Pin
68651	68651	1	Wrench- Socket
A-93791	A93791	1	WRENCH- Spanner ("S" Clutch)
23717A	23717A	1	PIN
24541	24541	1	SCREW DRIVER
A-17146	A17146	1	CLUTCH TOOL- (3 shoe-clutch)
17193	17193	1	GREASE- Multi use
70627	70627	1	ADHESIVE- Zip grip
DA-12272-E	DA12272E	1	BUMPER- Spiked
A-94284-B	A94284B	1	EXCHANGER- Heat
A-93693-A	A93693A	1	KIT- Chain brake
A-93967-A	A93967A	1	KIT- Hand guard
A-70790-B	A70790B	1	SAFE-T-TIP (STD)
A-96612	A96612	1	KIT- Guide bar insert
A-69496-B	A69496B	1	KIT- Sprocket repair
9311299	9311299	1	RUBBER-Tubing 10'
68848	68848	1	ROPE- Starter #4 250 FT. reel
A-70622	A70622	1	SET- Isolator- hard (set of four)
23475	23475	1	SPRAY CAN- Red