

Ref #	Part Number	Qty	Description
1	59274	1	GASKET- Spacer
2	59718	1	SPACER
3	63260A	1	RETAINER- Reed valve
4	63253	1	SEAT- Reed valve
5	59678B	4	VALVE- Reed
6	59722	1	GASKET- Carburetor
7	7031037	1	LINE- Fuel 9 1/4"
8	A68371B	1	CARBURETOR- Walbro (SDC-62)
	A68363BS	1	CARBURETOR- Tillotson (HS-179-B)
	A94953	1	CARBURETOR- Zama (#20-20)
9	68279	1	GROMMET
10	86324	1	PIN- Cotter
11	5877312	1	COVER-Air filter
12	A65272	1	NUT- Air filter cover
13	58319A	1	RING- Retaining
14	63589A	1	ELEMENT- Air filter
15	A59822B	1	BRACKET- Mounting
16	681301	1	ROD- Choke
17	58362	1	GROMMET
18	59763	1	ROD- Throttle
19	80891	5	SCREW- Hex 12-24 x 7/8
20	83046	2	WASHER- Lock #10
21	80921	2	SCREW- Hex 10-32 x 2 11/16
22	95671	1	PIN- Throttle latch
23	58405	1	SPRING- Throttle latch
24	A592131A	1	COVER- Throttle handle
	67752	1	Bushing- Pin (Not shown)
25	80560	2	SCREW- Pan 8-32 x 1/2
26	58859	1	TRIGGER- Throttle
27	58409	1	RING- Retaining
28	A93926	1	THROTTLE HANDLE
29	63290	1	WASHER- Felt
30	86301	1	PIN- Cotter
31	67634	1	BOOT- Throttle rod
32	63303	1	PLUG
33	93209	1	SHIELD- Spark plug
34	94142	1	PIN
35	A59011	1	VALVE- Check
36	63302B	1	SCREW- Idle
37	59770	1	GROMMET- Hi-Lo
38	A93783	1	PLUNGER- Spring
39	59293	1	SPRING- Compression
40	74388	1	"O" RING
42	96479	1	LABEL- Homelite

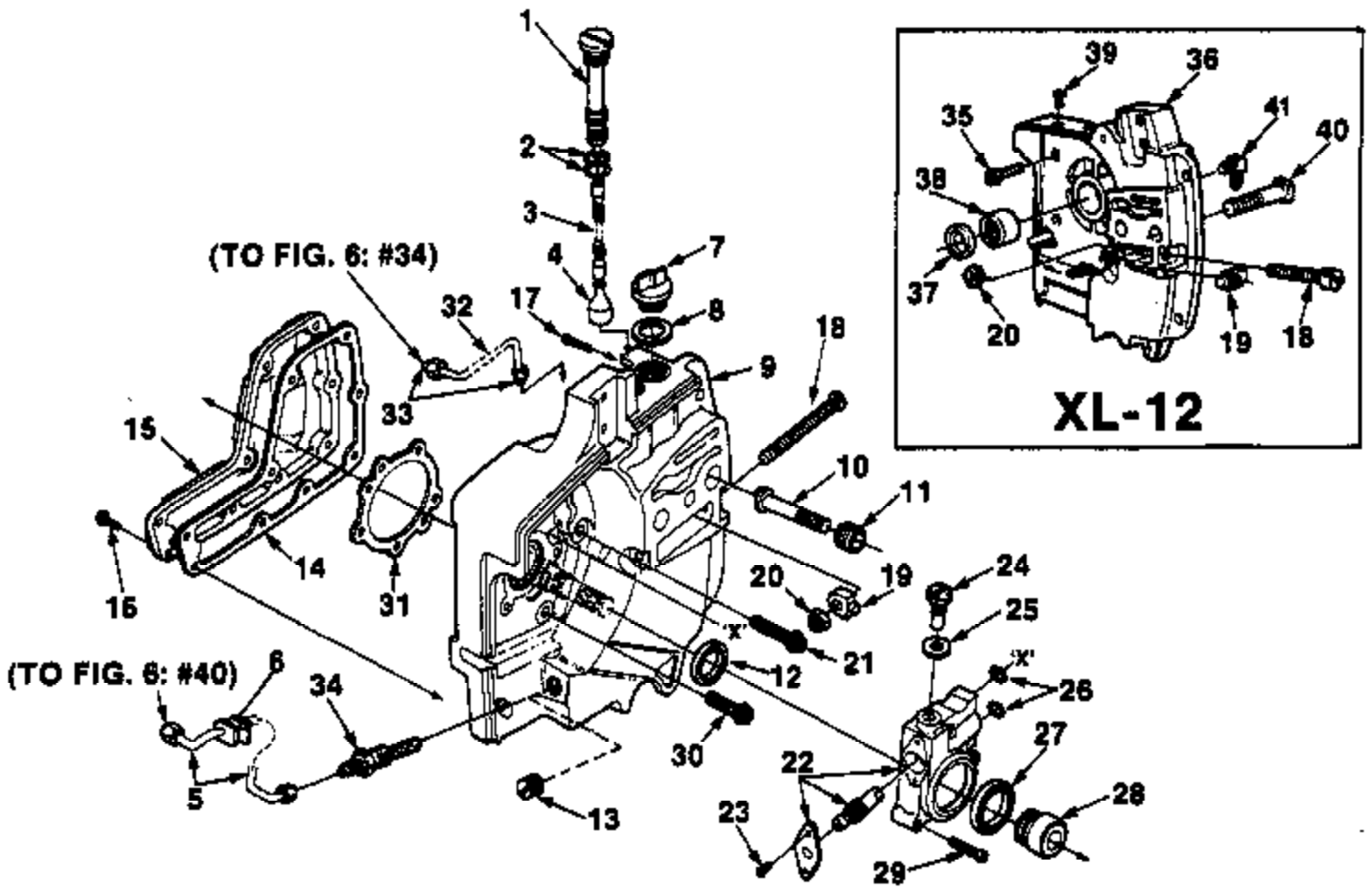

Ref #	Part Number	Qty	Description
7	A63717C	1	CAP- Filler oil
8	56607	1	GASKET
18	63225	1	SCREW- Guide bar adjusting
19	93039	1	PIN- Bar adjusting
20	81204	1	NUT- Lock, 1/4-20
30	80899	4	SCREW- Hex 12-24 x 9/16
31	63355	1	GASKET- Crankcase
35	80899	5	SCREW- (12-24 x 9/16)
36	A58925E	1	DRIVECASE
37	12282A	1	SEAL
38	58956	1	BEARING- Needle
39	94242	1	PLUG- Button
40	67485	2	BOLT- Guide bar
41	56707	1	FITTING- Tube elbow (90

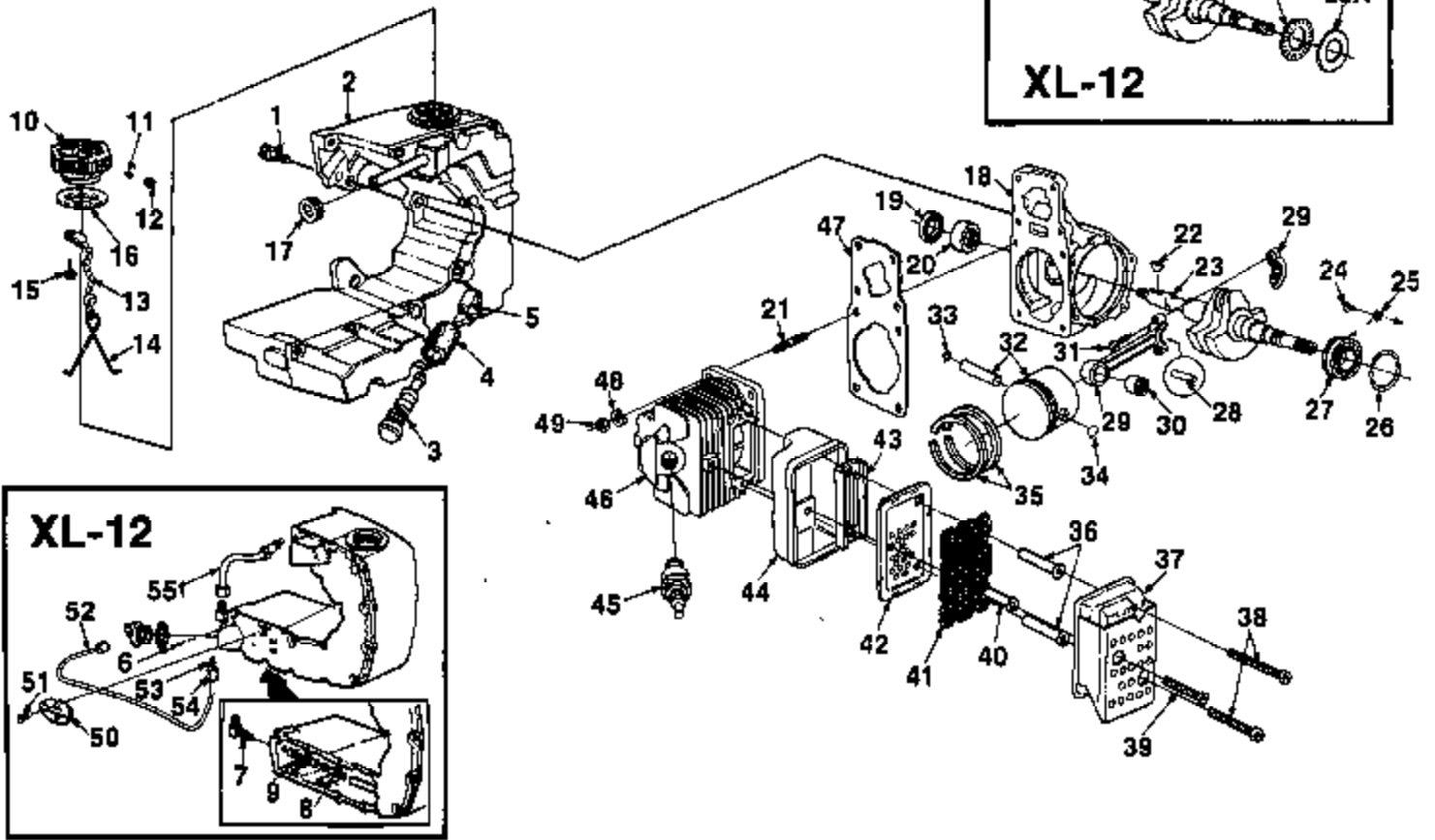

Ref #	Part Number	Qty	Description
1	63407	3	SCREW- Shoulder
2	A63898B	1	TANK- Fuel
3	A69923	1	FILTER- Fuel
4	64083	1	FELT- Filter
5	7031037	1	TUBING- Fuel 9 1/4"
6	86301	1	PIN- Cotter (Manual)
7	A59010	1	VALVE- Inlet check (Manual)
	25527	1	BALL (Not shown)
8	A59009A	1	FILTER- Oil (Manual)
9	59000	1	LINE- Pick-up (Manual)
10	A69500A	1	CAP- Fuel filler
11	69451	1	VALVE- Check
12	69454	1	FILTER- Fuel cap
13	69502	1	CHAIN- Bead
14	96535	1	RETAINER
15	82256A	1	SCREW- Pan hd. #6 x 1/4
16	69501	1	GASKET- Fuel filler cap
17	68046	1	GROMMET
18	A65736	1	CRANKCASE
19	12282A	1	SEAL
20	58956	1	BEARING
21	55871	4	STUD
22	75078	1	KEY- Woodruff
23A	634971	1	CRANKSHAFT
26A	58725	1	RACE- Needle thrust
27A	58726	1	BEARING- Needle thrust
28	A69054	1	ROLLER SET (31)
29	A63477B	1	ROD- Connecting
30	93369	1	BEARING
31	69919	2	SCREW- Cap soc. hd.
32	A58903C	1	PISTON & PIN
33	75120	1	RING- Retaining
34	64813	1	RING- Retaining
35	58877	2	PISTON RING
	A94219A	1	MUFFLER ASSEMBLY
36	9398301	2	SPACER- Muffler
37	A95988	1	CAP- Muffler & Shield
38	94128	2	SCREW- Hex hd. (12-24 x 2 1/4)
39	94129	1	SCREW- Hex hd. (12-24 x 1 7/8)
40	9398302	1	SPACER- Muffler
41	93979	1	SCREEN- Spark arrestor
42	93980	1	BAFFLE- Muffler
43	94133A	1	PLATE- Muffler
44	93981	1	BODY- Muffler
45	63710S	1	SPARK PLUG (CJ8)
46	A69715	1	CYLINDER
47	59771	1	GASKET- Cylinder
48	83061	4	WASHER- Lock 1/4
49	96212	4	NUT- 1/4-28
50	59016	1	PLATE- Retaining
51	80919	2	SCREW- Pan hd. (4-40 x 1/4)
52	A59012	1	LINE- Oil
53	25301	2	SLEEVE- Compression (1/8)
54	25302	1	NUT- Compression (5/16-24)
55	A94946	1	LINE- Oil

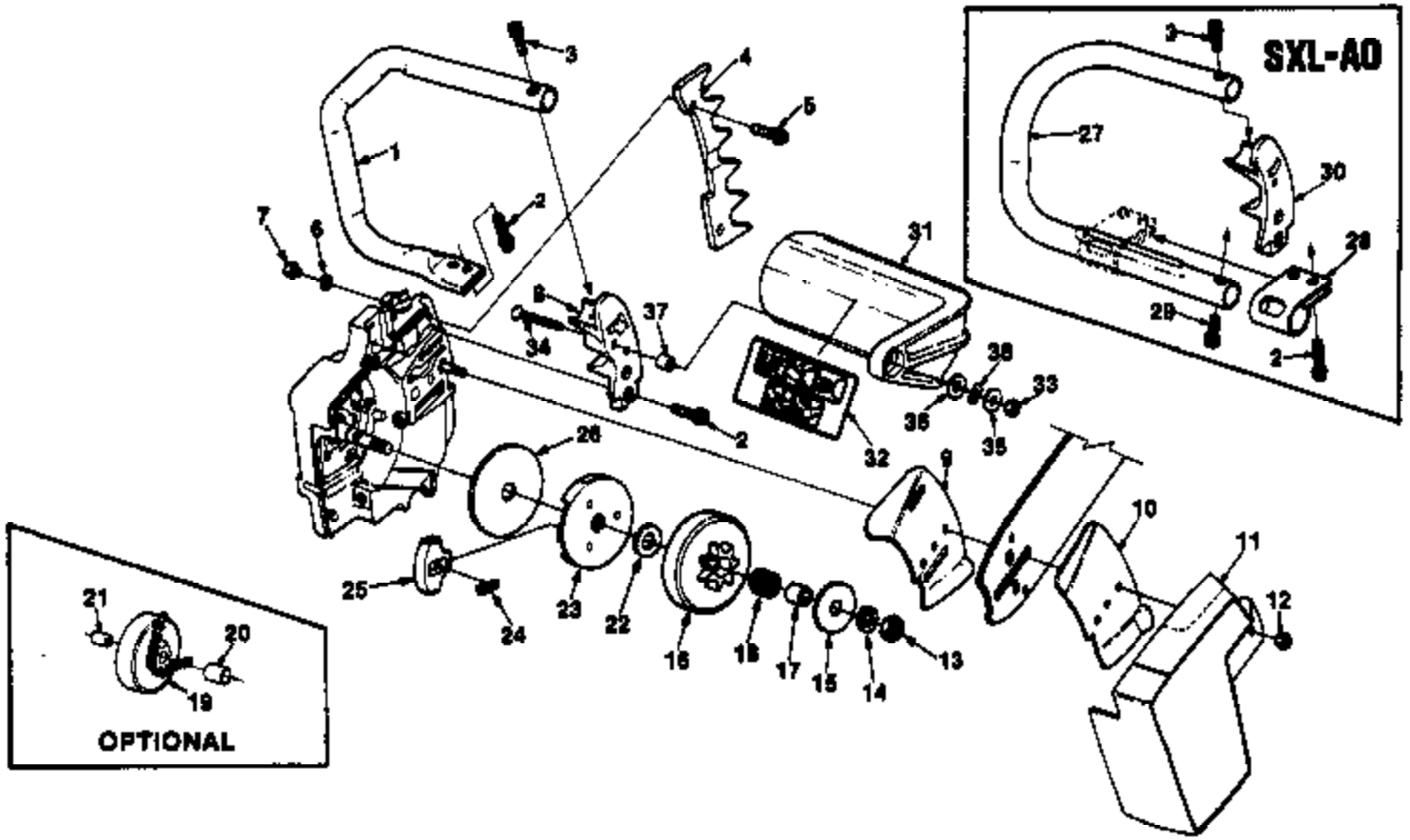

Ref #	Part Number	Qty	Description
1	A58793B	1	HANDLE BAR- Flush cut
2	80867	4	SCREW- 12-24 x 3/4
3	804281	1	SCREW- Socket hd. 1/4-20 x 1
4	DA59043	1	BUMPER KIT- Spiked (Accessory)
5	80867	2	SCREW- Hex 12-24 x 3/4
6	70901	2	WASHER- Lock #12
7	81068	2	NUT- Hex 12-24
8	592467	1	BRACKET- Handle bar
	A70618	1	KIT- Guide bar plate
9	70399	1	PLATE- Guide bar (inner)
10	70400	1	PLATE- Guide bar (outer)
11	5875016	1	COVER- Drivecase
12	810892	2	NUT- Hex 3/8-16
13	81124	1	NUT- Lock 3/8-24
14	83018	1	WASHER- Lock 3/8
15	65064	1	WASHER- Thrust (outer)
16	A95459	1	SPROCKET & DRUM 7 tooth (std.) 3/8,7 tooth
17	65746B	1	RACE- Inner
18	64124	1	BEARING- Roller
19	A63346	1	SPROCKET & DRUM (opt.) 3/8" pitch, 8T
	A59555	1	.404 pitch, 7 T
20	72311	1	BEARING- Needle
21	55584	1	RACE- Inner
	A65990	1	HUB & DRUM- "splined" (opt.) (used with index #17, 18, 22 and rim sprockets
	95058	1	SPROCKET- Splined rim typed 3/8" 7 T
	63285	1	.404 pitch, 7 tooth
22	58833	1	WASHER- Thrust (inner)
	A69480C	1	CLUTCH & COVER
23	657601B	1	PLATE- Clutch
24	67053	3	SPRING- Clutch
25	69461	3	SHOE- Clutch
26	95054	1	COVER- Clutch
31	A95088	1	GUARD- Hand
32	96990	1	DECAL
33	81225	1	NUT- 12/24
34	82223	4	SCREW- (12-24 x 1 1/4)
35	95935	1	WASHER (5/16)
36	84065	1	WASHER
37	95937	1	SPACER
38	96757	1	WASHER- Spring wave

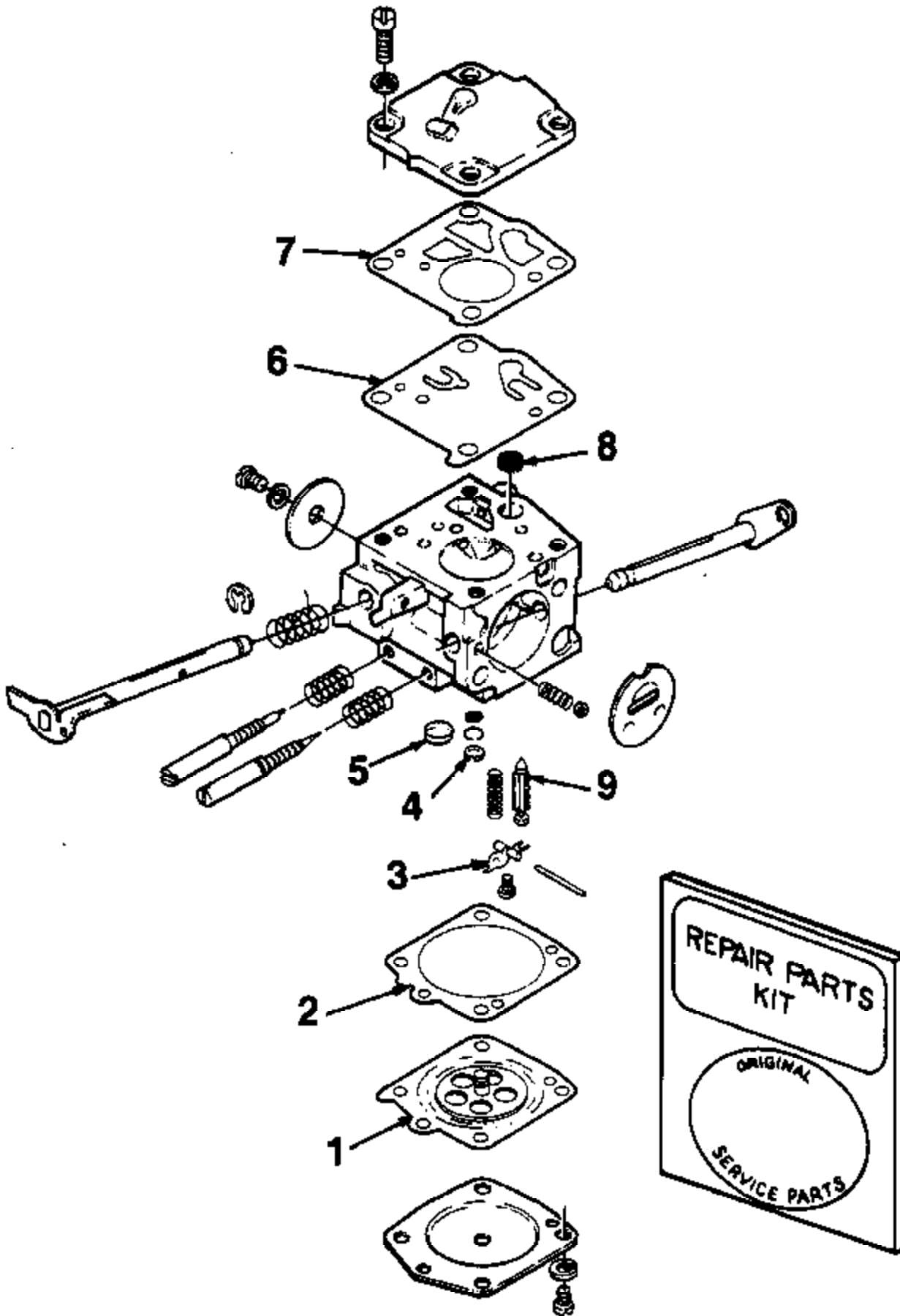

Ref #	Part Number	Qty	Description
1	95698	1	Repair Kit
2	95698	1	Repair Kit
3	95698	1	Repair Kit
4	95698	1	Repair Kit
5	95698	1	Repair Kit
6	95698	1	Repair Kit
7	95698	1	Repair Kit
8	95698	1	Repair Kit
9	95698	1	Repair Kit

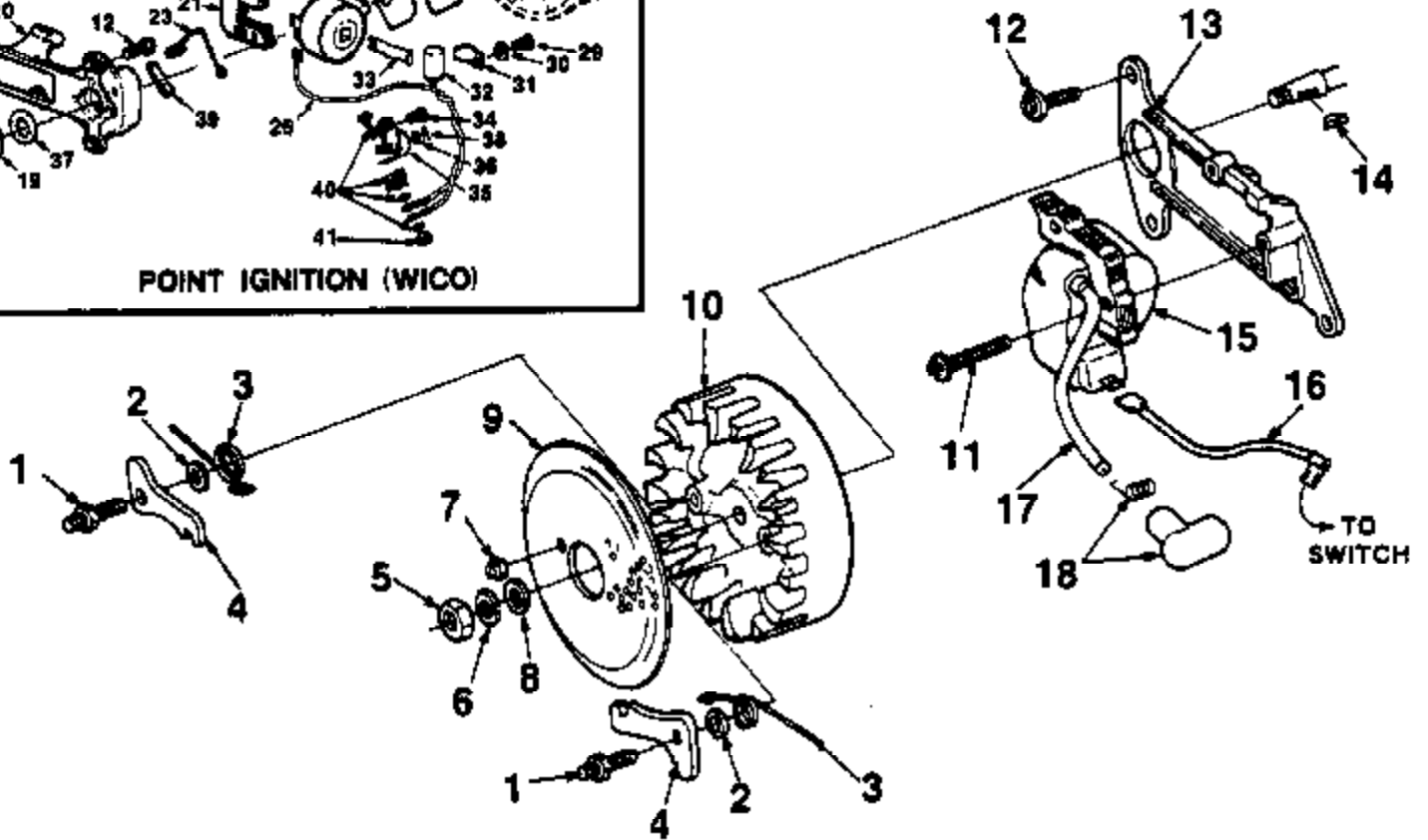
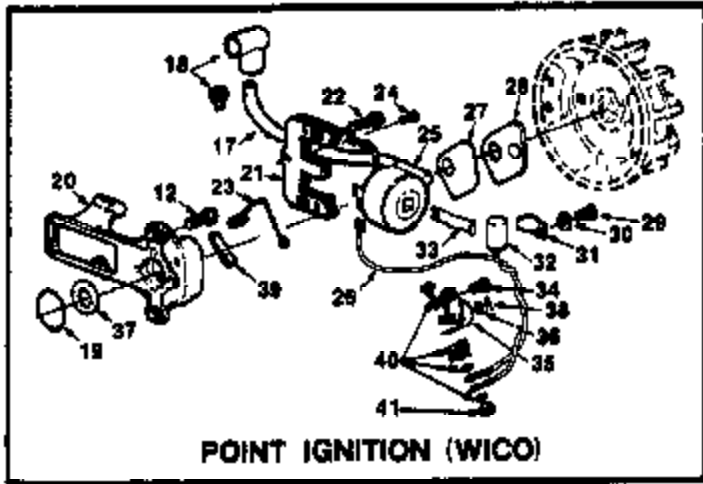

Ref #	Part Number	Qty	Description
1	58757E	2	STUD- Shoulder
2	70901	2	WASHER- Lock
3	653752	2	SPRING- Starter pawl
4	58756	2	PAWL- Starter
5	81117	1	NUT- Hex (5/16-24)
6	83002	1	WASHER- Lock (5/16)
7	81206	2	NUT- Center lock (#10-32)
8	84056	1	WASHER- Flat (5/16)
9	58765	1	SCREEN- Starter
10	70639	1	ROTOR- Magneto
11	82248	2	SCREW- Hex washer hd. (8-32 x 3/4)
12	80899	3	SCREW- Hex hd. (12-24 x 9/16)
13	943261	1	PLATE- Ignition coil mtg. (Solid state)
14	75078	1	KEY- Rotor (woodruff)
15	A94605S	1	MODULE & CORE (Solid state)
16	A94850	1	LEAD- Ground (Solid state)
	A59031	1	LEAD- Ground (Point ignition)
17	58966	1	LEAD- High tension
18	A33055	1	TERMINAL- High tension
19	59538	1	GASKET- Stator (point ignition)
20	A94556	1	BOX- Breaker (point ignition)
21	93098	1	CORE
22	82248	2	SCREW- Hex washer hd. (8-32 x 3/4)
23	76413	1	CLIP- Breaker box cover (point ignition)
24	64090	1	SCREW- Terminal (point ignition)
25	A94325	1	COIL- with lead (point ignition)
26	93095	1	LEAD
27	58810	1	GASKET- Breaker box cover (point ignition)
28	58811	1	COVER- Breaker box (point ignition)
29	30261	1	SCREW- Hd. (8-32 x 5/16) (point ignition)
30	83060	2	WASHER- Lock (point ignition)
31	59622	1	CLAMP- Condenser (point ignition)
32	63250A	1	CONDENSER (point ignition)
33	63726	1	CLIP- Coil retaining (point ignition)
34	76421	1	SCREW- Contact plate (point ignition)
35	A58914A	1	POINTS- Breaker (point ignition)
36	28028	A/R	WASHER- Plain
37	59760	1	SEAL- Felt
38	28008	1	CLIP
39		1	CAM- Felt
40	A68162	1	BLOCK- Terminal (point ignition)
41	93099	1	NUT- Connection stud

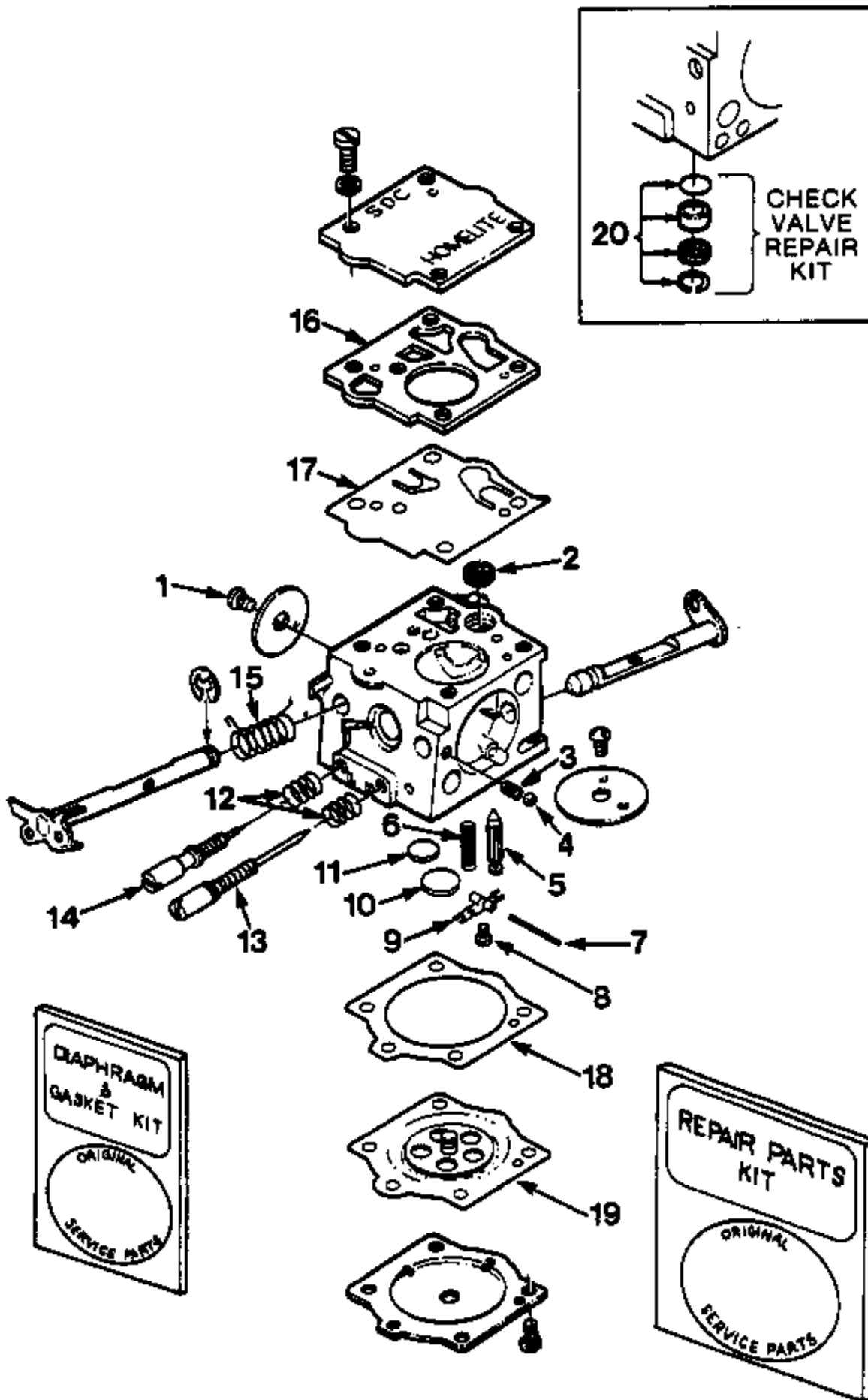

Ref #	Part Number	Qty	Description
1	67020	1	Repair Kit
2	67020	1	Repair Kit
3	67020	1	Repair Kit
4	67020	1	Repair Kit
5	67020	1	Repair Kit
	64229	1	Inlet Needle
6	67020	1	Repair Kit
7	67020	1	Repair Kit
8	67020	1	Repair Kit
9	67020	1	Repair Kit
10	67020	1	Repair Kit
11	67020	1	Repair Kit
12	67020	1	Repair Kit
13	67020	1	Repair Kit
14	67020	1	Repair Kit
15	67020	1	Repair Kit
16	67020	1	Repair Kit
	70811	1	Diaphragm & Gasket Kit
17	67020	1	Repair Kit
	70811	1	Diaphragm & Gasket Kit
18	67020	1	Repair Kit
	70811	1	Diaphragm & Gasket Kit
19	67020	1	Repair Kit
	70811	1	Diaphragm & Gasket Kit
20	93910A	1	Check Valve Kit

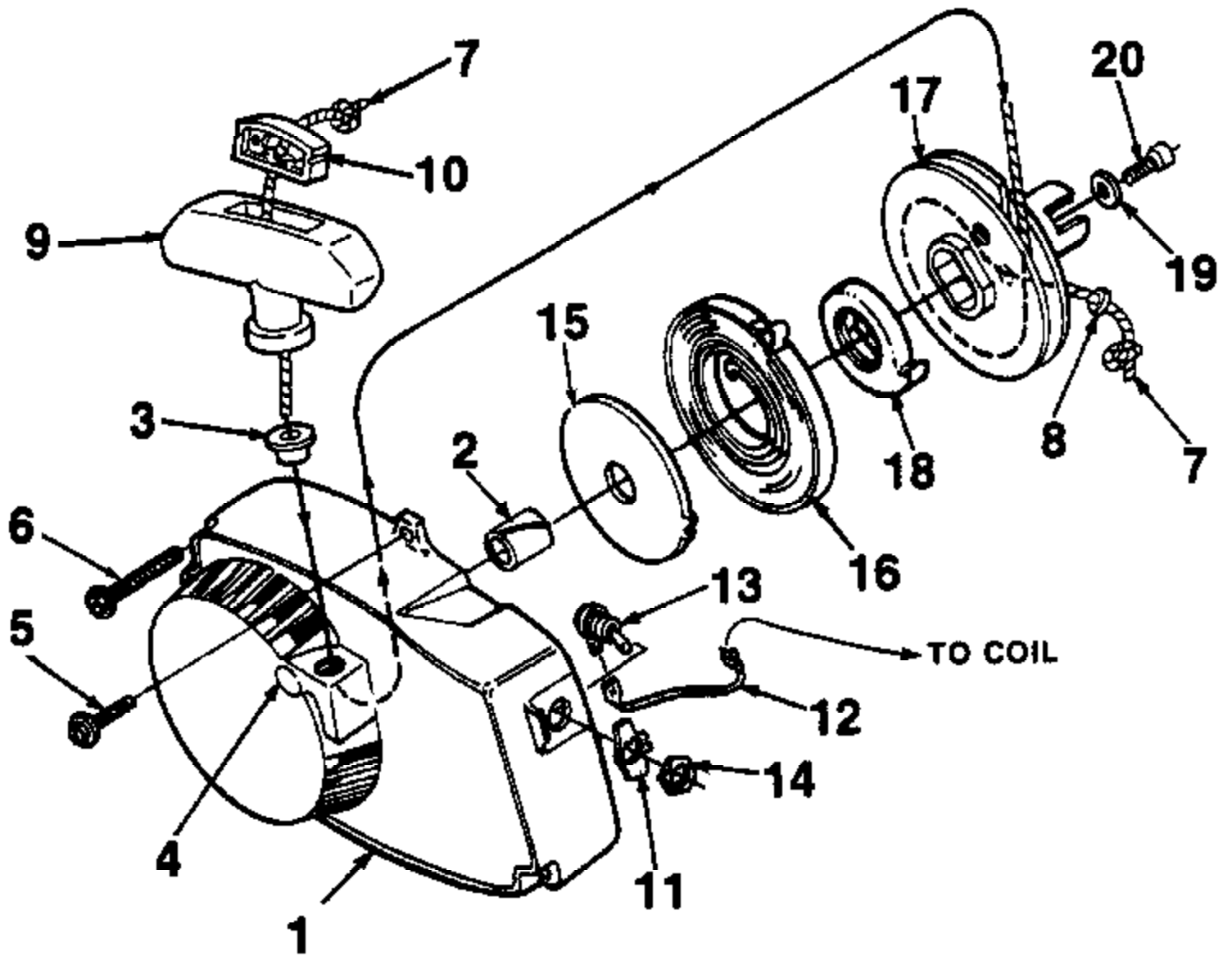

Ref #	Part Number	Qty	Description
1	A64518	1	HOUSING- Fan
2	64443	1	BUSHING- Starter
3	67177	1	BUSHING- Rope
4	59067	1	DRIVE- Stud
5	80899	1	SCREW- Hex 12-24 x 9/16
6	58963	3	SCREW- Hex 12-24 x 1 1/16
7	A93875	1	ROPE- Starter 48" long #5
8	93862	1	WASHER- Flat (nylon)
9	A69962B	1	GRIP- Starter rope
10	70018A	1	INSERT
11	95231	1	PLATE-"On-Off"
12	A94850	1	LEAD- Ground (solid state)
	A59031	1	LEAD- Ground (point ignition)
13	96831	1	SWITCH & LEAD
14	72084A1	1	NUT
15	59638B	1	SHIELD- Spring (inner)
16	A94842	1	SPRING- Recoil
17	A64446	1	PULLEY- Starter
18	94827	1	BUSHING- Spring
19	58763	1	WASHER- Retainer
20	80648	1	SCREW- Hex 10-32 x 1/2

TOOLS FOR XL-12

DESCRIPTION	PART NO.
PLIERS- Piston snap ring	22828
PLUG- Bearing assembly & disassembly	23758
PLUG- Bearing assembly & disassembly Drive & Crankcase	23757
PLUG- Seal assembly-drive & crankcase	23758
PLUG- Piston pin removal Includes:	A-23949
"O" RING	87900
PULLER- Magneto remover	A-24290
SLEEVE- Seal protecting-crankcase	23759
SLEEVE- Seal installation-drive and crankcase	23800
WRENCH- Hex socket screw (conn rod)	23828
WRENCH- Spanner to assemble & disassemble clutch Includes:	A-23834
PIN	23854
WRENCH- Socket	88851
SCREWDRIVER	24541
TOOL- Clutch removal (for clutch conversion kit)	A-17146

TOOLS FOR THE SXL-AO

DESCRIPTION	PART NO.
ANVIL- Crankshaft	23848-4
COLLAR- Ball bearing installation	22820-1
DRIVER- Check valve (for SDC carburetor)	24173
JACKSCREW	A-23137
PLIERS- Piston snap ring	22828
PLUG- Bearing assembly connecting rod Drive & Crankcase	23758 23757
PLUG- Seal assembly - drive & crankcase	23758
PLUG- Seal installation Drivecase assembly	23845
PLUG- Piston pin removal Includes:	A-23949
"O" RING	87900
PULLER- Magneto remover	A-24290
SLEEVE- Bearing & Shaft installation	23864-A
SLEEVE- Bearing & Shaft installation	23136-2A
SLEEVE- Seal protecting	23844
SLEEVE- Seal protecting crankcase	23759
SLEEVE- Seal installation drivecase	23843
SLEEVE- Seal installation drive & crankcase	23800
WRENCH- Hex socket screw (connecting rod)	23828
WRENCH- Spanner to assemble & disassemble clutch Includes:	A-23834
PIN	23854
WRENCH- Socket	88851
WRENCH- Insert	A-24322
SCREWDRIVER	24541
TOOL- Clutch removal (for clutch conversion kit)	A-17146
BIT- Driver torx 1/4" hex shank	24982-01
BIT- Driver torx 5/16" hex shank	24982-02

ACCESSORIES

DESCRIPTION	PART NO.	XL-12	SXL-AO
CLUTCH- Conversion Kit (Lined) Includes:	A-88745	1	1
SHOE- Clutch	A-83832-A	3	3
SPIDER- Clutch	83839	3	3
SPRING- Clutch	83814-A	3	3
SPROCKET & DRUM	A-85485	1	1
THRUST WASHER	83843	1	1
THRUST WASHER	83850	1	1
THRUST WASHER	85084	1	1
KIT- Manual oil pump (Prior to s/n 80440891) Includes:	A-85868	1	
BUTTON	57289-1	1	
LINE- OIL Includes:	A-88819	1	
GROMMET	58794	1	
VALVE- Check	A-88818	1	
FILTER- OIL (Intake)	A-88804-A	1	
PLUNGER Includes:	A-57834-10	1	
"O" RING	74388	1	
"O" RING	88074	1	
SPRING	88283	1	

When this Kit is assembled to the unit, the unit will have a complete manual oil pump system.

KIT- Hand guard Includes:	A-70910-A	1	
WASHER	88851-2	1	
WASHER	70768	1	
SLEEVE	70911	1	
SCREW- Machine flat hd.	70928	1	
SCREW	80946	1	
NUT	81225	1	
SCREW	82223	1	
DECAL	98990	1	
KIT- Hand Guard Includes:	A-70944-A	1	
WASHER	88851-2	1	
WASHER	70768	1	
SLEEVE	70911	1	
SCREW	80946	1	
NUT	81225	1	
KIT- Safe-T-TIP (Standard) Includes:	DA-70780-A	1	1
SCREW	82335	1	1
CARRY CASE	98920	1	1
REEL- Starting rope (250 Ft.) #5	57084-1	1	1
KIT- Insert (for drivecase guide barrels) Includes:	A-70370-A	1	
TUBING- Rubber 10 ft. (Fuel)	70310-88	1	1
TUBING- Rubber 10 ft. (Oil)	70309-89	1	1
THROTTLE HANDLE			
CONVERSION KIT (For the XL-12 single reed system)	A-97553	1	

PAINT

DESCRIPTION	PART NO.	XL-12	SXL-AO
LACQUER- Red	23475	1	1
LACQUER- Black	22772	1	1

Ref #	Part Number	Qty	Description
22828	22828	1	PLIERS- Piston snap ring
23756	23756	1	PLUG- Bearing assembly & disassembly
23757	23757	1	PLUG- Bearing assembly & disassembly Drive & Crankcase
23758	23758	1	PLUG- Seal assembly-drive & crankcase
A-23949	A23949	1	PLUG- Piston pin removal
67900	67900	1	"O" RING
A-24290	A24290	1	PULLER- Magneto remover
23759	23759	1	SLEEVE- Seal protecting-crankcase
23800	23800	1	SLEEVE- Seal installation-drive and crankcase
23528	23528	1	WRENCH- Hex socket screw (conn rod)
A-23934	A23934	1	WRENCH- Spanner to assembly & disassemble clutch
23954	23954	1	PIN
68651	68651	1	WRENCH- Socket
24541	24541	1	SCREWDRIVER
A-17146	A17146	1	TOOL- Clutch removal (for clutch conversion kit)
238464	238464	1	ANVIL- Crankshaft
22820-1	228201	1	COLLAR- Ball bearing installation
24173	24173	1	DRIVER- Check valve (or SDC carburetor)
A-23137	A23137	1	JACKSCREW
22828	22828	1	PLIERS- Piston snap ring
23756	23756	1	PLUG- Bearing assembly connecting rod
23757	23757	1	Drive & Crankcase
23758	23758	1	PLUG- Seal assembly - drive & crankcase
23845	23845	1	PLUG- Seal installation drivecase assembly
A-23949	A23949	1	PLUG- Piston pin removal
67900	67900	1	"O" RING
A-24290	A24290	1	PULLER- Magneto remover
23884-A	23884A	1	SLEEVE- Bearing & Shaft installation
23136-2A	231362A	1	SLEEVE- Bearing & Shaft installation
23844	23844	1	SLEEVE- Seal protecting
23759	23759	1	SLEEVE- Seal protecting crankcase
23843	23843	1	SLEEVE- Seal installation drivecase
23800	23800	1	SLEEVE- Seal installation drive & crankcase
23528	23528	1	WRENCH- Hex socket screw (connecting rod)
A-23934	A23934	1	WRENCH- Spanner to assemble & Disassemble clutch
23954	23954	1	PIN
68651	68651	1	WRENCH- Socket
A-24322	A24322	1	WRENCH- Insert
24541	24541	1	SCREWDRIVER
A-17146	A17146	1	TOOL- Clutch removal (for clutch conversion kit)
2498201	2498201	1	BIT- Driver torx 1/4" hex shank
2498202	2498202	1	BIT- Driver torx 5/16" hex shank
A-96745	A96745	1	CLUTCH- Conversion Kit (Lined)
A-93632-A	A93632A	3	SHOE- Clutch
93639	93639	3	SPIDER- Clutch
93814-A	93814A	3	SPRING- Clutch
A-95465	A95465	1	SPROCKET & DRUM
93643	93643	1	THRUST WASHER
93650	93650	1	THRUST WASHER
65064	65064	1	THRUST WASHER
A-65868	A65868	1	KIT- Manual oil pump (Prior to s/n 50440501)
57289-1	572891	1	BUTTON
A-59819	A59819	1	LINE- Oil
59794	59794	1	GROMMET
A-59818	A59818	1	VALVE- Check
A-59804-A	A59804A	1	FILTER- Oil (intake)
A-57834-10	A5783410	1	PLUNGER
74388	74388	1	"O" RING

Ref #	Part Number	Qty	Description
59074	59074	1	"O" RING
59293	59293	1	SPRING
A-70910-A	A70910A	1	KIT- Hand guard
588512	588512	1	WASHER
70788	70788	1	WASHER
70911	70911	1	SLEEVE
70926	70926	1	SCREW- Machine flat hd.
80945	80945	1	SCREW
81225	81225	1	NUT
82223	82223	1	SCREW
96990	96990	1	DECAL
A-70944-A	A70944A	1	KIT- Hand Guard
588512	588512	1	WASHER
70788	70788	1	WASHER
70911	70911	1	SLEEVE
80945	80945	1	SCREW
81225	81225	1	NUT
DA70790A	DA70790A	1	KIT- Safe-T-TIP (Standard)
82335	82335	1	SCREW
95920	95920	1	CARRY CASE
57084-1	570841	1	REEL- Starting rope (250 Ft.) #5
A-70370-A	A70370A	1	KIT- Insert (for drivecase guide barstuds)
7031099	7031099	1	TUBING- Rubber 10 ft. (Fuel)
7030999	7030999	1	TUBING- Rubber 10 ft. (Oil)
A-97553	A97553	1	THROTTLE HANDLE CONVERSION KIT (For the XL-12 single reed system)
23475	23475	1	LACQUER- Red
22772	22772	1	LACQUER- Black

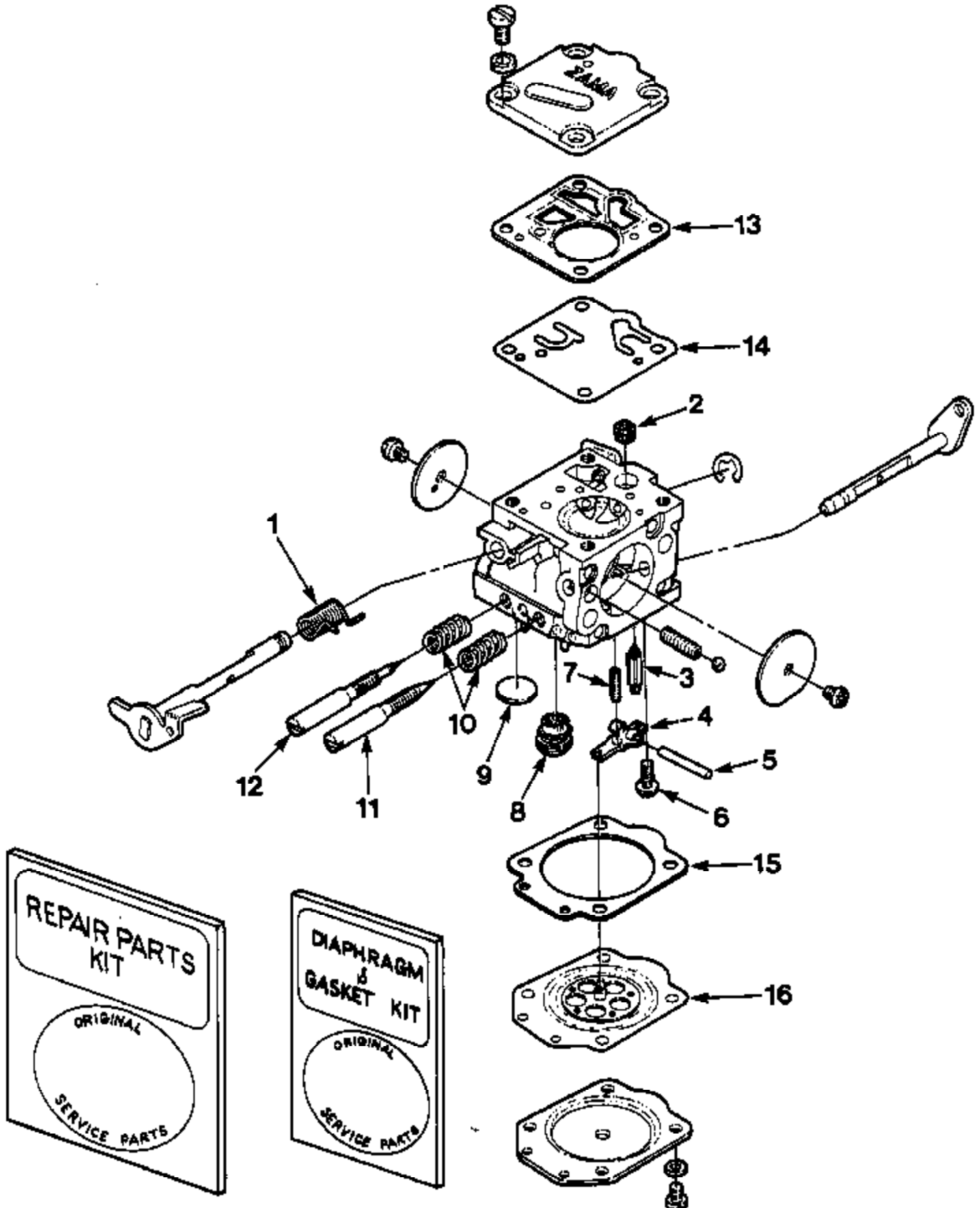

Ref #	Part Number	Qty	Description
1	94954	1	Repair Kit
2	94954	1	Repair Kit
3	94954	1	Repair Kit
4	94954	1	Repair Kit
5	94954	1	Repair Kit
6	94954	1	Repair Kit
7	94954	1	Repair Kit
8	94954	1	Repair Kit
9	94954	1	Repair Kit
10	94954	1	Repair Kit
11	94954	1	Repair Kit
12	94954	1	Repair Kit
13	94954	1	Repair Kit
	94952	1	Diaphragm & Gasket Kit
14	94954	1	Repair Kit
	94952	1	Diaphragm & Gasket Kit
15	94954	1	Repair Kit
	94952	1	Diaphragm & Gasket Kit
16	94954	1	Repair Kit
	94952	1	Diaphragm & Gasket Kit