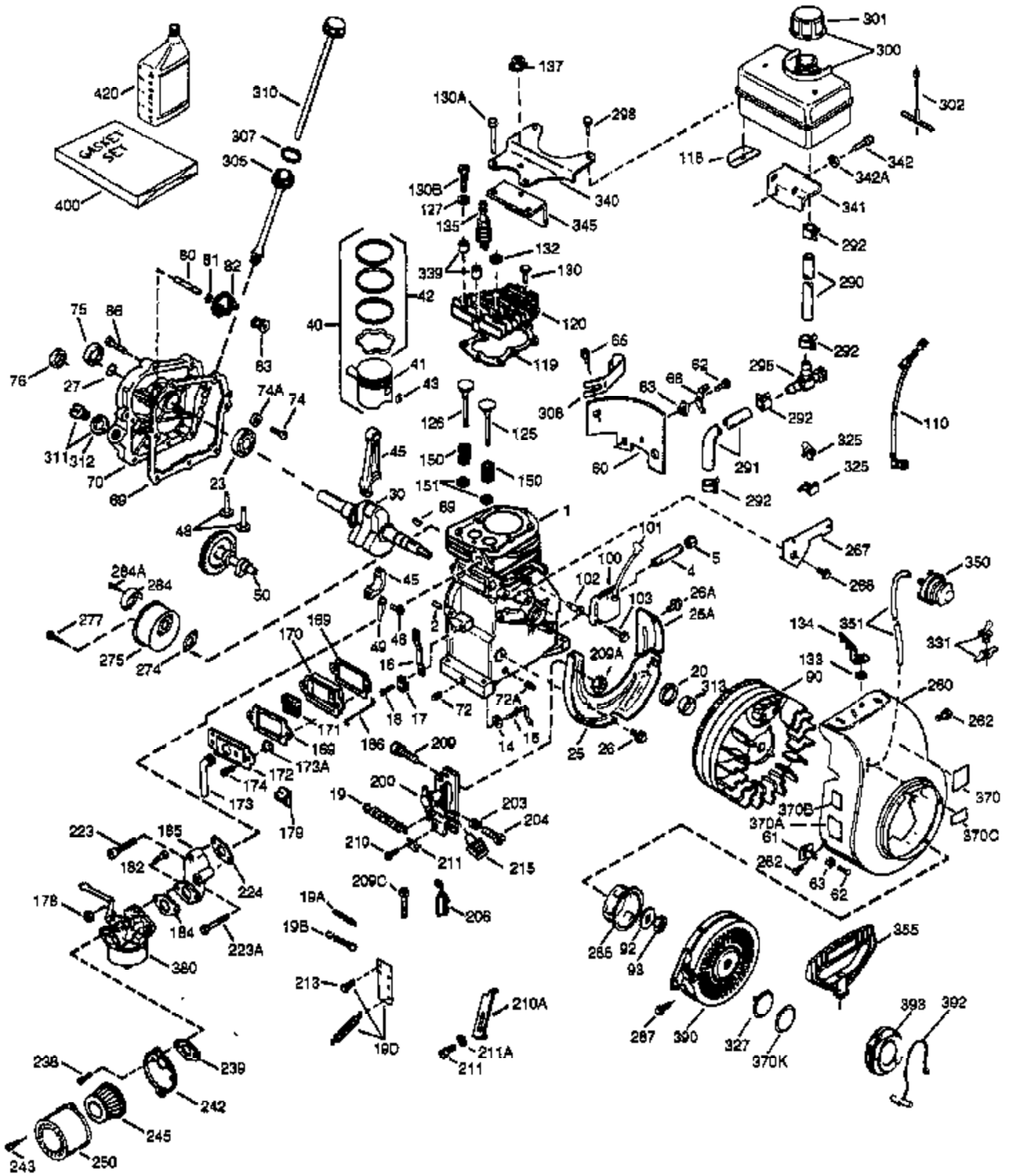

ILLUSTRATION SHOWS TYPICAL PARTS ONLY. ORDER BY PART NUMBER. PARTS NOT LISTED ARE SUPPLIED BY OEM.

VIEW 1 OF 2



Ref #	Part Number	Qty	Description
1	35764	1	Cylinder (Incl. 2, 20 & 72)
2	26727	2	Dowel Pin
14	28277	1	Washer
15	31334	1	Governor Rod
16	31510	1	Governor Lever
17	31335	1	Governor Lever Clamp
18	650548	1	Screw, 8-32 x 5/16"
19	31426	1	Extension Spring
20	32600	1	Oil Seal
23	28458	1	Ball Bearing
25	33342	1	Blower Housing Baffle
25A	35883	1	Baffle Extension
26	650561	2	Screw, 1/4-20 x 5/8"
26A	650926	1	Screw, 8-32 x 21/64"
27	28539	1	Retaining Ring
30	34727	1	Crankshaft
40	34514	1	Piston, Pin & Ring Set (Std.)
40	34515	1	Piston, Pin & Ring Set (.010" OS)
40	34516	1	Piston, Pin & Ring Set (.020" OS)
41	32538B	1	Piston & Pin Ass'y. (Std.) (Incl. 43)
41	32548B	1	Piston & Pin Ass'y. (.010" OS) (Incl. 43)
41	32549B	1	Piston & Pin Ass'y. (.020" OS) (Incl. 43)
42	28986	1	Ring Set (Std.)
42	28987	1	Ring Set (.010" OS)
42	28988	1	Ring Set (.020" OS)
43	20381	2	Piston Pin Retaining Ring
45	30963B	1	Connecting Rod Ass'y. (Incl. 46 & 49)
46	32610A	2	Connecting Rod Bolt
48	27241	2	Valve Lifter
49	28594	1	Oil Dipper
50	33149A	1	Camshaft (BCR)
60	29745	1	Blower Housing Extension
65	650128	1	Screw, 10-24 x 1/2"
69	27677A	1	* Cylinder Cover Gasket
70	30756C	1	Cylinder Cover (Incl. 75 thru 83, 311 & 312)
72	27642	2	Oil Drain Plug
74	30200	2	Screw, 10-24 x 9/16"
74A	28537	2	Washer
75	28540	1	Oil Seal
80	30574A	1	Governor Shaft
81	30590A	1	Washer
82	30591	1	Governor Gear Ass'y. (Incl. 81)
83	30588A	1	Governor Spool
86	650488	7	Screw, 1/4-20 x 1-1/4"
89	610961	1	Flywheel Key
90	611080	1	Flywheel
92	650815	1	Belleville Washer
93	650816	1	Flywheel Nut
100	34443A	1	Solid State Ignition
101	610118	1	Spark Plug Cover
102	650872	2	Solid State Mounting Stud
103	650814	2	Screw, Torx T-15, 10-24 x 1
110	35182	1	Ground Wire
119	29953C	1	* Cylinder Head Gasket
120	30579A	1	Cylinder Head (Incl. 130)
125	29313C	1	Exhaust Valve (Std.) (Incl. 151)
125	29315C	1	Exhaust Valve (1/32" OS) (Incl. 151)
126	29314B	1	Intake Valve (Std.) (Incl. 151)

Ref #	Part Number	Qty	Description
126	29315C	1	Intake Valve (1/32" OS) (Incl. 151)
130	650694A	5	Screw, 5/16-18 x 2"
131	6021A	3	Screw, 5/16-18 x 1-1/2"
135	33636	1	Resistor Spark Plug (RJ17LM)
150	31672	2	Valve Spring
151	31673	2	Valve Spring Cap
169	27234A	2	* Valve Cover Gasket
170	27666	1	Breather Body
171	31410	1	Breather Element
172	34146	1	Valve Cover
173	35350	1	Breather Tube
174	30200	2	Screw, 10-24 x 9/16"
178	29752	2	Nut & Lock Washer, 1/4-28
182	6201	2	Screw, 1/4-28 x 7/8"
184	26756	1	* Carburetor To Intake Pipe Gasket
185	28416A	1	Intake Pipe
186	31858	1	Governor Link
200	33858A	1	Control Bracket (Incl.19,203,204,206)
203	31342	1	Compression Spring
204	650549	1	Screw, 5-40 x 7/16"
206	610973	1	Terminal
215	32410	1	Control Knob
223A	650840	1	Screw, 1/4-20 x 1-7/32"
223	650664	1	Screw, 1/4-20 x 1-19/32"
224	26754A	1	* Intake Pipe Gasket
238	28820	2	Screw, 10-32 x 1/2"
239	27272A	1	* Air Cleaner Gasket
242	31691	1	Air Cleaner Base
243	650152	2	Screw, 8-32 x 3/8"
245	31700	1	Air Cleaner Filter
250	31715	1	Air Cleaner Cover
260	35585	1	Blower Housing
261	29212	2	Screw, 1/4-28 x 7/16"
267	34212	1	Hold Down Bracket
268	30200	1	Screw, 10-24 x 9/16"
275	35603A	1	Muffler (Incl. 277)
277	650795	2	Screw, 1/4-20 x 2-1/4"
285	34694	1	Starter Cup
287	650926	2	Screw, 8-32 x 21/64"
290	30705	1	Fuel Line
292	26460	2	Fuel Line Clamp
298	650665	2	Screw, 1/4-15 x 7/8"
300	35584	1	Fuel Tank (Incl. 292 & 301)
301	35355	1	Fuel Cap
311	27625	1	Oil Fill Plug (Incl. 312)
312	29673	1	* Oil Fill Plug Gasket
313	34080	1	Spacer
327	35392	1	Starter Plug
340	36247	1	Fuel Tank Bracket
342	650751	1	Screw, 1/4-20 x 7/16"
345	33344	1	Heat Baffle
370	34686	1	Name Decal
370A	34346	1	Lubrication Decal
370B	35344	1	Throttle Decal
380	631921	1	Carburetor (Incl. 184)
390	590688	1	Rewind Starter

Ref #	Part Number	Qty	Description
400	33233A	1	* Gasket Set (Incl. items marked PK i n notes) Incl. part #'s 26754A (1), 26756 (1), 27234A (2), 27272A (1), 27677A (1), 29673 (2), 29953C (1), 30081A (1), 31340A (1), 31619A (1), 31688A (2), 32649A (1), 33170A (1)
420	730225	1	SAE 30 4-Cycle Engine Oil (Quart)

ILLUSTRATION SHOWS TYPICAL PARTS ONLY. ORDER BY PART NUMBER. PARTS NOT LISTED ARE SUPPLIED BY OEM.

VIEW 2 OF 2

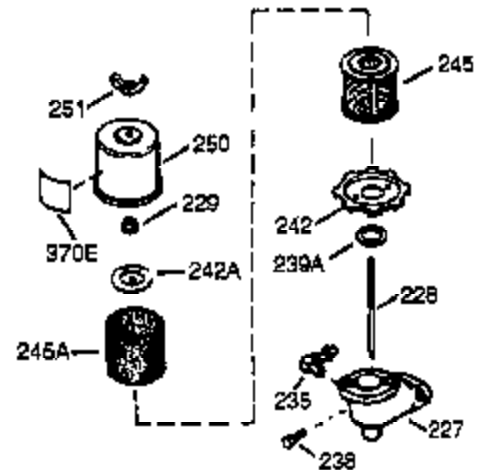
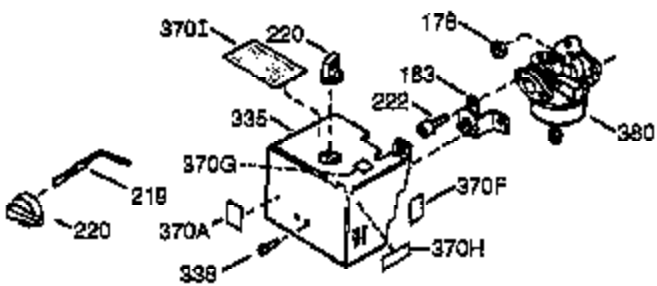
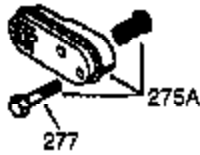
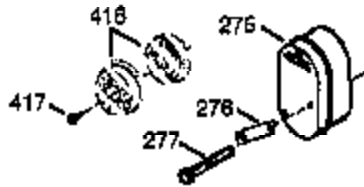
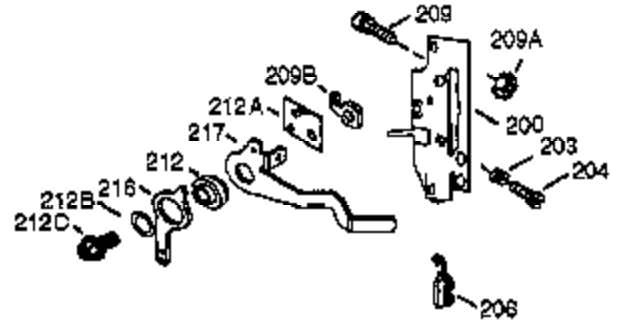
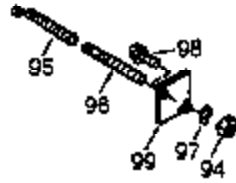

OPTIONAL 110 - 120 VOLT  
STARTER MOTOR KIT



396

Ref #	Part Number	Qty	Description
16	31510	1	Governor Lever
17	31335	1	Governor Lever Clamp
18	650548	1	Screw, 8-32 x 5/16"
131	6021A	3	Screw, 5/16-18 x 1-1/2"
178	29752	2	Nut & Lock Washer, 1/4-28
200	33858A	1	Control Bracket (Incl.19,203,204,206)
203	31342	1	Compression Spring
204	650549	1	Screw, 5-40 x 7/16"
206	610973	1	Terminal
238	28820	2	Screw, 10-32 x 1/2"
242	31691	1	Air Cleaner Base
245	31700	1	Air Cleaner Filter
250	31715	1	Air Cleaner Cover
261	29212	2	Screw, 1/4-28 x 7/16"
275	35603A	1	Muffler (Incl. 277)
276	33753	1	Locking Plate
277	650795	2	Screw, 1/4-20 x 2-1/4"
370A	34346	1	Lubrication Decal
380	631921	1	Carburetor (Incl. 184)