

ILLUSTRATION SHOWS TYPICAL PARTS ONLY. ORDER BY PART NUMBER. PARTS NOT LISTED ARE SUPPLIED BY OEM.

VIEW 1 OF 2



Ref #	Part Number	Qty	Description
	1 36560	1	Cylinder (Incl. 2,20,72 & 125)
	2 26727	2	Dowel Pin
	14 28277	1	Washer
	15 31334	1	Governor Rod
	16 31336	1	Governor Lever
	17 31335	1	Governor Lever Clamp
	18 651018	1	Screw, Torx T-15, 8-32 x 19/64"
	19 34593	1	Extension Spring
	20 32600	1	Oil Seal
	25A 35883	1	Baffle Extension
	25 36552	1	Blower Housing Baffle (Incl. 262)
	26A 650926	1	Screw, 8-32 x 21/64"
	26 650802	2	Screw, 1/4-20 x 5/8"
	30 34709	1	Crankshaft
	40 40020	1	Piston, Pin & Ring Set (Std.)
	40 40021	1	Piston, Pin & Ring Set (.010" OS)
	41 40018	1	Piston & Pin Ass'y. (Std.) (Incl. 43)
	41 40019	1	Piston & Pin Ass'y. (.010" OS) (Incl. 43)
	42 40022	1	Ring Set (Std.)
	42 40023	1	Ring Set (.010" OS)
	43 20381	2	Piston Pin Retaining Ring
	45 30963B	1	Connecting Rod Ass'y. (Incl. 46 & 49)
	46 32610A	2	Connecting Rod Bolt
	48 27241	2	Valve Lifter
	49 28594	1	Oil Dipper
	50 32197A	1	Camshaft (MCR)
	60 29745	1	Blower Housing Extension
	65 650128	1	Screw, 10-24 x 1/2"
	69 27677A	1	* Cylinder Cover Gasket
	70 35863A	1	Cylinder Cover (Incl. 75 thru 83,311)
	72 27642	2	Oil Drain Plug
	75 26208	1	Oil Seal
	80 30574A	1	Governor Shaft
	81 30590A	1	Washer
	82 30591	1	Governor Gear Ass'y. (Incl. 81)
	83 30588A	1	Governor Spool
	86 650488	7	Screw, 1/4-20 x 1-1/4"
	89 610961	1	Flywheel Key
	90 611195	1	Flywheel
	92 650815	1	Belleville Washer
	93 650816	1	Flywheel Nut
	100 34443B	1	Solid State Ignition
	101 610118	1	Spark Plug Cover
	102 650872	2	Solid State Mounting Stud
	103 651007	2	Screw, Torx T-15, 10-24 x 15/16"
	110 35182	1	Ground Wire
	119 36437	1	* Cylinder Head Gasket
	120 36438	1	Cylinder Head (Incl. 119 & 130)
	125 36471	1	Exhaust Valve (Std.) (Incl. 151)
	125 36472	1	Exhaust Valve (1/32" OS) (Incl. 151)
	126 29314C	1	Intake Valve (Std.) (Incl. 151)
	126 29315C	1	Intake Valve (1/32" OS) (Incl. 151)
	130A 6021A	1	Screw, 5/16-18 x 1-1/2"
	130 650694A	7	Screw, 5/16-18 x 2"
	132 650708	1	Washer
	135 33636	1	Resistor Spark Plug (RJ17LM)
	150 31672	2	Valve Spring
	151 31673	2	Valve Spring Cap

Ref #	Part Number	Qty	Description
169	27234A	2	* Valve Cover Gasket
170	27666	1	Breather Body
171	31410	1	Breather Element
172	34146	1	Valve Cover
173A	32446	1	Breather Tube Grommet
173	32447	1	Breather Tube
174	650783	2	Screw, 10-24 x 3/4"
178	29752	2	Nut & Lock Washer, 1/4-28
179	30593	1	Retainer Clip
182	6201	2	Screw, 1/4-28 x 7/8"
184	26756	1	* Carburetor To Intake Pipe Gasket
185	36703	1	Intake Pipe (Incl. 182,184,224)
186	31341	1	Governor Link
200	36677	1	Control Bracket (Incl.203 thru 209A)
203	31342	1	Compression Spring
204	651029	1	Screw, 5-40 x 7/16"
206	610973	1	Terminal
209	650139	2	Screw, 8-32 x 1/2"
209A	30322	2	Lock Nut, 8-32
215	35440	1	Control Knob
223	650451	2	Screw, 1/4-20 x 1"
224	26754A	1	* Intake Pipe Gasket
238	650932	2	Screw, 10-32 x 49/64"
239	34338	1	* Air Cleaner Gasket
245	35066	1	Air Cleaner Filter
250	35986	1	Air Cleaner Cover
260	35585	1	Blower Housing
262	650737	2	Screw, 1/4-20 x 1/2"
275	40024	1	Muffler (W/Catalyst)
277	650988	2	Screw, 1/4-20 x 2-5/16"
285	36467A	1	Starter Cup
287	650926	2	Screw, 8-32 x 21/64"
290	29774	1	Fuel Line
292	26460	2	Fuel Line Clamp
298	650665	2	Screw, 1/4-15 x 7/8"
300	35591	1	Fuel Tank (Incl. 292 & 301)
301	36246	1	Fuel Cap
311	27625	1	Oil Fill Plug
313	34080	1	Spacer
339	28212	2	Spacer
340	35926	1	Fuel Tank Bracket
342	650751	1	Screw, 1/4-20 x 7/16"
345	32664	1	Baffle Heat
370A	36261	1	Lubrication Decal
370B	35703	1	Control Decal
370K	36695	1	Starter Decal
380	640172	1	Carburetor (Incl. 184)
390	590732	1	Rewind Starter (NOTE: This engine could have been built with 590738 starter).
400	36439	1	* Gasket Set (Incl. items marked PK in notes) Incl. part #'s 26754A (1), 26756 (1), 27234A (2), 27272A (1), 27677A (1), 29673 (2), 30081A (1), 31688A (2), 36437 (1)
420	730225	1	SAE 30 4-Cycle Engine Oil (Quart)

ILLUSTRATION SHOWS TYPICAL PARTS ONLY. ORDER BY PART NUMBER. PARTS NOT LISTED ARE SUPPLIED BY OEM.

VIEW 2 OF 2

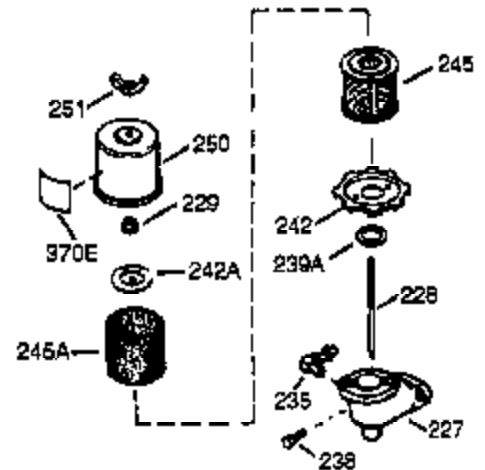
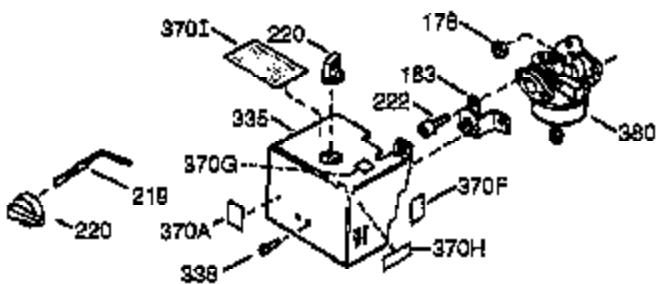
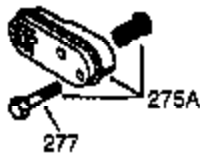
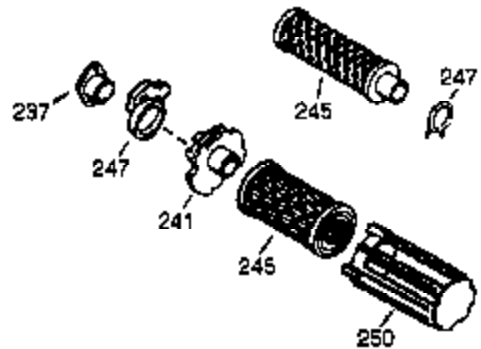
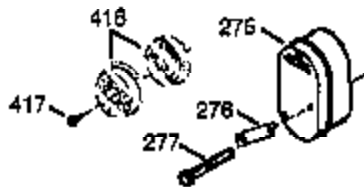
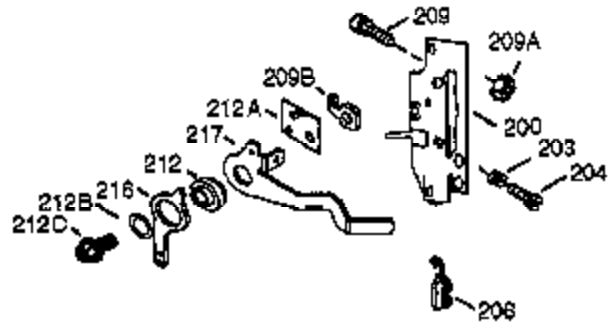
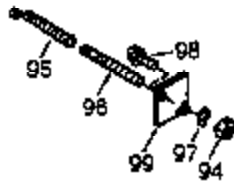

OPTIONAL 110 - 120 VOLT
STARTER MOTOR KIT



396

Ref #	Part Number	Qty	Description
16	31336	1	Governor Lever
17	31335	1	Governor Lever Clamp
18	651018	1	Screw, Torx T-15, 8-32 x 19/64"
178	29752	2	Nut & Lock Washer, 1/4-28
200	36677	1	Control Bracket (Incl.203 thru 209A)
203	31342	1	Compression Spring
204	651029	1	Screw, 5-40 x 7/16"
206	610973	1	Terminal
209A	30322	2	Lock Nut, 8-32
209	650139	2	Screw, 8-32 x 1/2"
238	650932	2	Screw, 10-32 x 49/64"
241	35797	1	Air Cleaner Collar
245	35066	1	Air Cleaner Filter
250	35986	1	Air Cleaner Cover
275	40024	1	Muffler (W/Catalyst)
277	650988	2	Screw, 1/4-20 x 2-5/16"
370A	36261	1	Lubrication Decal
380	640172	1	Carburetor (Incl. 184)