

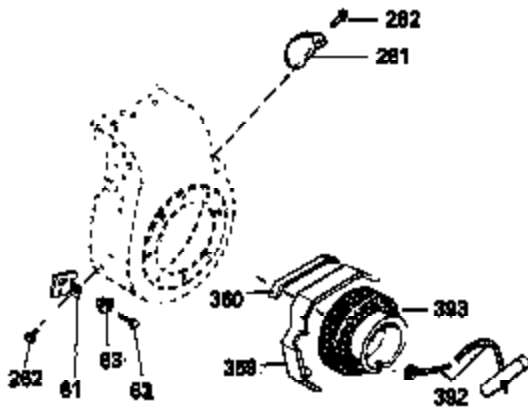

Ref #	Part Number	Qty	Description
1	34919B	1	Cylinder (Incl. 2, 20 & 72)
2	27652	2	Dowel Pin
15B	650494	1	Screw, 6-40 x 5/16"
15	30699C	1	Governor Rod (Incl. 15A & 15B)
15A	30700	1	Governor Yoke
16	32326A	1	Governor Lever
16A	30205	1	Governor Bracket
18	650548	1	Screw, 8-32 x 5/16"
20	32630	1	Oil Seal
25	29536	1	Blower Housing Baffle
26	650561	2	Screw, 1/4-20 x 5/8"
30	35191	1	Crankshaft
35	29826	1	Screw, 10-32 x 3/4"
36	29918	1	Lock Washer
37	29216	1	Lock Nut, 10-32
38	29642	1	Retaining Ring
40	34531	1	Piston, Pin & Ring Set (Std.)
40	34532	1	Piston, Pin & Ring Set (.010" OS)
40	34533	1	Piston, Pin & Ring Set (.020" OS)
41	33312B	1	Piston & Pin Ass'y. (Std.) (Incl. 43)
41	33313B	1	Piston & Pin Ass'y. (.010" OS) (Incl. 43)
41	33314B	1	Piston & Pin Ass'y. (.020" OS) (Incl. 43)
42	34854	1	Ring Set (Std.)
42	34855	1	Ring Set (.010" OS)
42	34856	1	Ring Set (.020" OS)
43	27888	2	Piston Pin Retaining Ring
45	31295C	1	Connecting Rod Ass'y. (Incl. 46)
46	650662C	2	Connecting Rod Bolt
48	34034	2	Valve Lifter
50	33156	1	Camshaft (BCR)
60	30622A	1	Blower Housing Extension
65	650128	1	Screw, 10-24 x 1/2"
69	30684	1	* Cylinder Cover Gasket
70	31303C	1	Cylinder Cover (Incl. 71, 75 & 80)
71	31546	1	Crankshaft Bushing
72	27642	2	Oil Drain Plug
75	28427	1	Oil Seal
80	31845	1	Governor Shaft
81	30590A	1	Washer
82	30591	1	Governor Gear Ass'y. (Incl. 81)
83	30588A	1	Governor Spool
84	29193	1	Retaining Ring
86	650488	7	Screw, 1/4-20 x 1-1/4"
87	650493	1	Screw, 1/4-20 x 1-3/4"
89	32589	1	Flywheel Key
90	611084	1	Flywheel
92	650815	1	Belleville Washer
93	8116	1	Flywheel Nut
100	34443A	1	Solid State Ignition
102	650872	2	Solid State Mounting Stud
103	650814	2	Screw, Torx T-15, 10-24 x 1"
110	35269	1	Ground Wire
119	28938B	1	* Cylinder Head Gasket
120	30938A	1	Cylinder Head (Incl. 3 of 130)
125	27878A	1	Exhaust Valve (Std.) (Incl. 151)
125	27880A	1	Exhaust Valve (1/32" OS) (Incl. 151)
126	32783	1	Intake Valve (Std.) (Incl. 151)
126	32784	1	Intake Valve (1/32" OS) (Incl. 151)

Ref #	Part Number	Qty	Description
127	650691	3	Washer
128	650690	3	Belleville Washer
130	650697A	8	Screw, 5/16-18 x 2-1/2"
135	33636	1	Resistor Spark Plug (RJ17LM)
139	31843A	1	Governor Gear Bracket
140	650836	2	Screw, 10-24 x 1/2"
149	27882	2	Valve Spring Cap
150	27881	2	Valve Spring
151	32581	2	Valve Spring Keeper
169	27896	2	* Valve Cover Gasket
170	28423	1	Breather Body
171	28424	1	Breather Element
172	28425	1	Valve Cover
173	35350	1	Breather Tube
174	650128	1	Screw, 10-24 x 1/2"
182	650517	2	Screw, 1/4-20 x 27/32"
184	31688	1	* Carburetor To Intake Pipe Gasket
207	32327	1	Throttle Link
224	27915	1	* Intake Pipe Gasket
238	650152	2	Screw, 8-32 x 3/8"
239	27272A	1	* Air Cleaner Gasket
240	31691	1	Air Cleaner Bracket
243	28820	2	Screw, 10-32 x 1/2"
245	30727	1	Air Cleaner Filter
250	31715	1	Air Cleaner Cover
260	32158E	1	Blower Housing
262	29747B	2	Screw, Torx T-40, 5/16-24 x 21/32"
265	30939A	1	Cylinder Head Cover
272	30196	2	Screw, 5/16-18 x 3/4"
273	34712	1	Carburetor Flange
274	35865	1	* Exhaust Manifold Gasket
275	32401	1	Muffler
277A	30196	1	Screw, 5/16-18 x 3/4"
277	650694A	1	Screw, 5/16-18 x 2"
279A	26073	1	Washer
285	32125	1	Starter Cup
286	35009	1	Starter Screen
287	29716	4	Screw, 1/4-28 x 7/16"
291	30962	1	Fuel Line
292	26460	2	Fuel Line Clamp
298	650665	2	Screw, 1/4-15 x 3/4"
300	34186A	1	Fuel Tank (Incl. 292 & 301)
301	35355	1	Fuel Cap
305	35554	1	Oil Fill Tube
307	35499	1	"O" Ring
308	35540	1	Fill Tube Clip
310	35555	1	Dipstick
331A	610650B	1	Toggle Switch
340	34159	1	Fuel Tank Bracket
341	34158	1	Fuel Tank Bracket
342	650561	1	Screw, 1/4-20 x 5/8"
370A	33183	1	Stop-Run Decal
380	632230	1	Carburetor (Incl. 184)
390	590420	1	Rewind Starter
400	33235A	1	* Gasket Set (Incl. items marked PK i n notes) Incl. part #'s 27272A (2), 27896A (2), 27913A (1), 27915A (2), 28938C (1), 29673 (1), 30684 (1), 31688A (1), 33355A (1), 35865 (1)

Ref #	Part Number	Qty	Description
420	730225	1	SAE 30 4-Cycle Engine Oil (Quart)
453	29538	1	Engine Mounting Base
454	650542	4	Screw, 5/16-18 x 3/4"



OPTIONAL 110-120
VOLT STARTER
MOTOR KIT

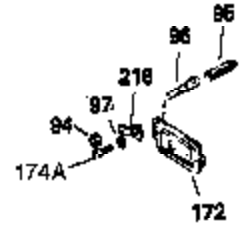
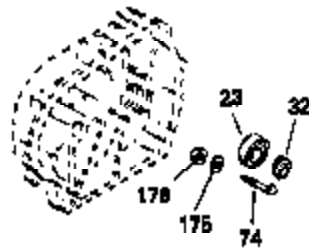
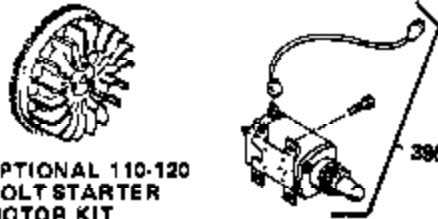

OPTIONAL SPARK ARREST
MUFFLER

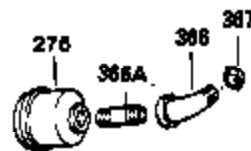
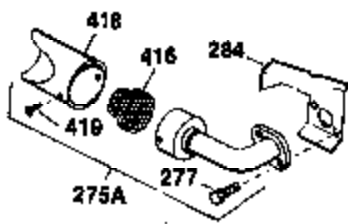

Ref #	Part Number	Qty	Description
94	33450	1	Lock Nut, 10-32
95	30886A	1	Extension Spring
96	30845A	1	R.P.M. Adjusting Bolt
97	xxxxx	1	Lock Washer (Purchase Locally)
110	35269	1	Ground Wire
172	28425	1	Valve Cover
174A	650597	1	Screw, 10-24 x 5/8"
216	32328	1	R.P.M. Adjusting Bracket
262	29747B	2	Screw, Torx T-40, 5/16-24 x 21/32"
274	35865	1	* Exhaust Manifold Gasket
275	32401	1	Muffler
277A	30196	1	Screw, 5/16-18 x 3/4"
277	650694A	1	Screw, 5/16-18 x 2"
291	30962	1	Fuel Line
331A	610650B	1	Toggle Switch
370B	35274	1	Instruction Decal
370	34346	1	Instruction Decal

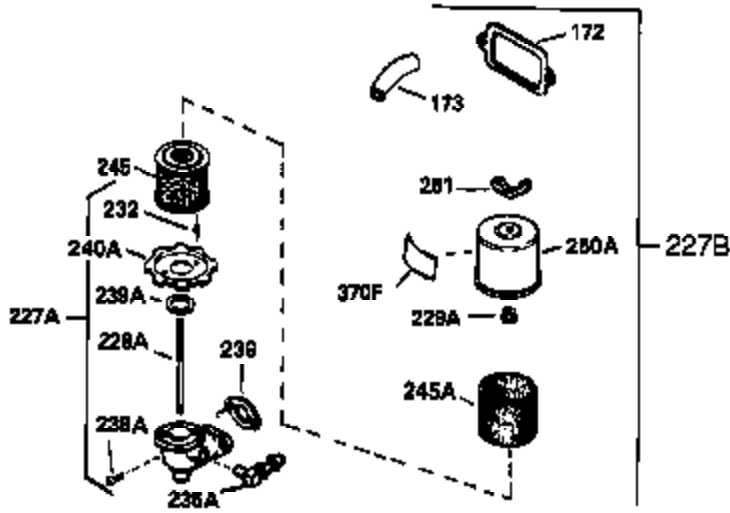

**ADD-ON ALTERNATOR
 AC LIGHTING OR DC CHARGING**



**OPTIONAL
 STARTER MUFF KIT**
 730571
 Can be used on H50-60 with
 stamped steel starter.

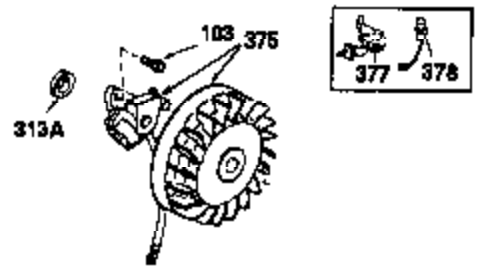

SOLID STATE



Ref #	Part Number	Qty	Description
90	611084	1	Flywheel
100	34443A	1	Solid State Ignition
102	650872	2	Solid State Mounting Stud
103	650814	2	Screw, Torx T-15, 10-24 x 1"
172	28425	1	Valve Cover
173	35350	1	Breather Tube
239	27272A	1	* Air Cleaner Gasket
245	30727	1	Air Cleaner Filter
277A	30196	1	Screw, 5/16-18 x 3/4"
291	30962	1	Fuel Line
331A	610650B	1	Toggle Switch