

Ref #	Part Number	Qty	Description
	1 35385	1	Cylinder (Incl. 2, 20 & 72)
	2 27652	2	Dowel Pin
	3 650820	2	Screw, 1/4-20 x 1/2"
	4 34171	1	Oil Drain Extension
	5 30969	1	Extension Cap
	15B 650494	1	Screw, 6-40 x 5/16"
	15A 30700	1	Governor Yoke
	15 30699C	1	Governor Rod (Incl. 15A & 15B)
	16 33454	1	Governor Lever
	17 29916	1	Governor Lever Clamp
	18 650548	1	Screw, 8-32 x 5/16"
	19 34663	1	Speed Control Spring
	20 35319	1	Oil Seal
	25 36460	1	Blower Housing Baffle
	26 650561	2	Screw, 1/4-20 x 5/8"
	28 30322	1	Lock Nut, 8-32
	30 35980A	1	Crankshaft
	35 29826	1	Screw, 10-32 x 3/4"
	36 29918	1	Lock Washer
	37 29216	1	Lock Nut, 10-32
	38 29642	1	Retaining Ring
	40 34552	1	Piston, Pin & Ring Set (Std.)
	40 34553	1	Piston, Pin & Ring Set (.010" OS)
	40 34554	1	Piston, Pin & Ring Set (.020" OS)
	41 34329A	1	Piston & Pin Ass'y. (Std.) (Incl. 43)
	41 34330A	1	Piston & Pin Ass'y. (.010" OS) (Incl. 43)
	41 34331A	1	Piston & Pin Ass'y. (.020" OS) (Incl. 43)
	42 34332	1	Ring Set (Std.)
	42 34333	1	Ring Set (.010" OS)
	42 34334	1	Ring Set (.020" OS)
	43 27888	2	Piston Pin Retaining Ring
	45 35373A	1	Connecting Rod Ass'y. (Incl.46,47,49)
	46 650908	1	Connecting Rod Bolt
	47 650882	1	Connecting Rod Bolt
	48 34034	2	Valve Lifter
	49 35374	1	Oil Dipper
	50 35981	1	Camshaft (MCR)
	60 33273A	1	Blower Housing Extension
	61 34126	1	Grommet Mounting Bracket
	62 650760	1	Screw, 8-32 x 3/8"
	63 28545	1	Grommet
	65 650128	1	Screw, 10-24 x 1/2"
	69 35262	1	* Cylinder Cover Gasket
	70 35445A	1	Cylinder Cover (Incl. 71, 75 & 80)
	71 35377	1	Crankshaft Bushing
	75 35319	1	Oil Seal
	76 28926	1	* Camshaft Seal
	80 31845	1	Governor Shaft
	81 30590A	1	Washer
	82 35378	1	Governor Gear Ass'y. (Incl. 81)
	83 30588A	1	Governor Spool
	84 29193	1	Retaining Ring
	86 650833	7	Screw, 1/4-20 x 1-3/16"
	87 650832	1	Screw, 1/4-20 x 1-11/16"
	89 32589	1	Flywheel Key
	90 611093	1	Flywheel (W/Ring Gear)
	92 650880	1	Lock Washer
	93 650881	1	Flywheel Nut

Ref #	Part Number	Qty	Description
100	35135	1	Solid State Ignition
101	610118	1	Spark Plug Cover
102	650872	2	Solid State Mounting Stud
103	650814	2	Screw, Torx T-15, 10-24 x 1"
110	35253	1	Ground Wire
119	36448	1	* Cylinder Head Gasket
120	36449	1	Cylinder Head
125	27878A	1	Exhaust Valve (Std.) (Incl. 151)
125	27880A	1	Exhaust Valve (1/32" OS) (Incl.151)
126	34036	1	Intake Valve (1/32" OS) (Incl.151)
126	34035	1	Intake Valve (Std.) (Incl. 151)
127	650691	2	Washer
129	650727	2	Screw, 5/16-18 x 1-3/4"
130	6021A	7	Screw, 5/16-18 x 1-1/2"
131A	650713	2	Screw, 5/16-18 x 5/8"
135	35395	1	Resistor Spark Plug (RJ17LM)
139	33369	1	Governor Gear Bracket
140	650836	2	Screw, 10-24 x 1/2"
149A	35862	1	Valve Spring Cap
149	27882	1	Valve Spring Cap
150	27881	2	Valve Spring
151	32581	2	Valve Spring Keeper
169	27896A	2	* Valve Cover Gasket
170	28423	1	Breather Body
171	28424	1	Breather Element
172	28425	1	Valve Cover
173	35350	1	Breather Tube
174	650128	2	Screw, 10-24 x 1/2"
178	29752	2	Nut & Lock Washer, 1/4-28
182	30088A	2	Screw, 1/4-28 x 1"
183	34587	1	Choke Bracket
184	33263	1	* Carburetor To Intake Pipe Gasket
185	33877	1	Intake Pipe
186	34667	1	Governor Link
200	34677	1	Control Bracket (Incl. 19, 203, 204 & 206)
203	31342	1	Compression Spring
204	650549	1	Screw, 5-40 x 7/16"
206	610973	1	Terminal
207	33878	1	Throttle Link
209	650821	2	Screw, 10-32 x 1/2"
215	35440	1	Control Knob
219	34586	1	Choke Rod
220	35438	1	Choke Knob
222	28820	2	Screw, 10-32 x 1/2"
223	650378	2	Screw, Torx T-30, 5/16-18 x 1-1/8"
224	27915A	1	* Intake Pipe Gasket
260	35447A	1	Blower Housing
261	650788	2	Screw, 5/16-18 x 3/4"
262	29747B	2	Screw, Torx T-40, 5/16-24 x 21/32"
264A	650802	1	Screw, 1/4-20 x 5/8"
265	33272B	1	Cylinder Head Cover
275	35056	1	Muffler
276	31588	1	Locking Plate
277	651002	2	Screw, 5/16-18 x 4-3/16"
285	35985A	1	Starter Cup
287	29752	4	Nut & Lock Washer, 1/4-28
290	29774	1	Fuel Line
291	30705	1	Fuel Line

Ref #	Part Number	Qty	Description
292	26460	4	Fuel Line Clamp
295	35857	1	Fuel Shut-Off Valve
298	650665	2	Screw, 1/4-15 x 7/8"
300	34156A	1	Fuel Tank (Incl. 292 & 301)
301	35355	1	Fuel Cap
305	35554	1	Oil Fill Tube
307	35499	1	"O" Ring
308	35540	1	Fill Tube Clip
310	36205	1	Dipstick
314	650873	1	Screw, 1/4-20 x 3/4"
315	611111	1	Alternator Coil (18 Watt)(Incl. 323)
323	611118	1	Terminal
325	29443	1	Wire Clip
328	35062	2	Ignition Key
329	610973	1	Terminal
335	35057A	1	Carburetor Cover
336	650765	1	Screw, 10-32 x 1/2"
338	28942	2	Screw, 10-32 x 3/8"
340	34154	1	Fuel Tank Bracket
341	34155	1	Fuel Tank Bracket
342	650561	1	Screw, 1/4-20 x 5/8"
350	570682	1	Primer Ass'y.
351	32180C	1	Primer Line
355	590574	1	Starter Handle
361	30063	2	Screw, Torx T-30, 1/4-20 x 1/2"
361A	650819	2	Screw, 6-32 x 2-1/2"
364	33377	1	Carburetor Cover Bracket
365	650767	2	Screw, 8-32 x 27/64"
370C	34414	1	Warning Decal
370B	36261	1	Instruction Decal
370A	36501	1	Primer Decal
370	35077	1	Control Decal
380	632334A	1	Carburetor (Incl. 184)
390	590672	1	Rewind Starter
395	33329D	1	Electric Starter Motor (120 Volt)
400	36450	1	* Gasket Set (Incl. items marked PK i n notes) Incl. part #'s 27272A (1),27896A (2), 27915A (1), 29673 (1), 33263 (1), 33629 (1), 34689A (1), 35262 (1), 36448 (1)
420	730226	1	SAE 5W30 4-Cycle Engine Oil (Quart)

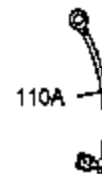
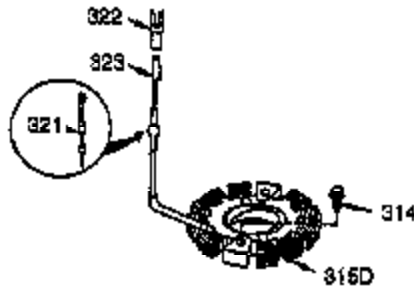
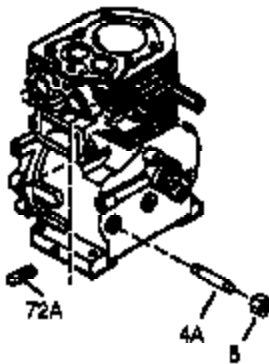
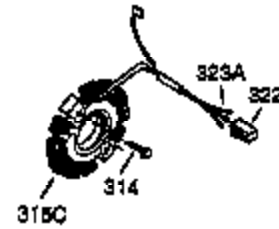
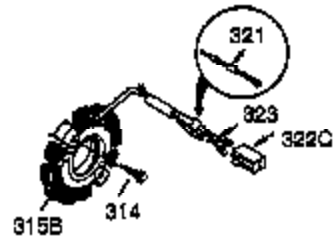
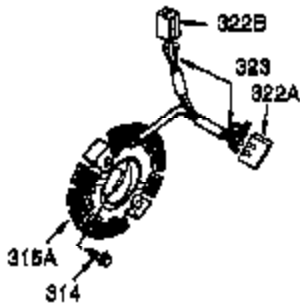
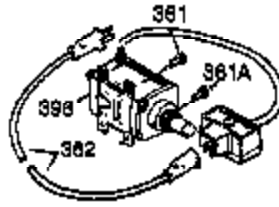
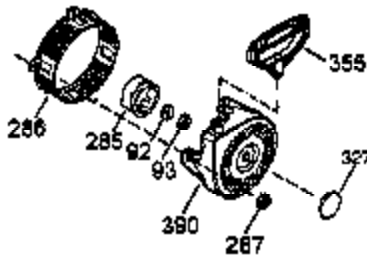

Ref #	Part Number	Qty	Description
	5 30969	1	Extension Cap
	62 650760	1	Screw, 8-32 x 3/8"
	63 28545	1	Grommet
	92 650880	1	Lock Washer
	93 650881	1	Flywheel Nut
110A	35305	1	Ground Wire
129	650727	2	Screw, 5/16-18 x 1-3/4"
131A	650713	2	Screw, 5/16-18 x 5/8"
	285 35985A	1	Starter Cup
	286 35446	1	Starter Screen
	287 29752	4	Nut & Lock Washer, 1/4-28
	314 650873	1	Screw, 1/4-20 x 3/4"
	323 611118	1	Terminal
	327 35392	1	Starter Plug
	355 590574	1	Starter Handle
361A	650819	2	Screw, 6-32 x 2-1/2"
	361 30063	2	Screw, Torx T-30, 1/4-20 x 1/2"
	390 590672	1	Rewind Starter