

Ref #	Part Number	Qty	Description
	1 xxxxx	1	Cylinder (Order S/B if replacement is needed)
16B	490291A	1	Air Vane
19	570707	1	Extension Spring
24	530110	1	Ball Bearing
29A	530104A	1	Cartridge Bearing
29	530150	1	Needle Bearing & Liner Set (37 Needle s)
30	290607	1	Crankshaft
33A	570644	1	Cover Plate
34A	650579	4	Screw, Torx T-25, 10-24 x 1/2"
41	310283A	1	Piston & Pin Ass'y. (Incl. 43)
42	310190	2	Ring Set
43	310167	2	Piston Pin Retaining Ring
45	310235B	1	Connecting Rod Ass'y. (Incl. 29, 29A, & 46)
46	650633	4	Connecting Rod Bolt
69	510292A	1	* Cylinder Cover Gasket
69A	510323A	1	* Cover Plate Gasket
75	510319	2	Oil Seal
77	530105	1	Cartridge Bearing
89A	611032	1	Adapter Sleeve
90	611066	1	Flywheel
92	650815	1	Belleville Washer
93	650390	1	Flywheel Nut
100	34443A	1	Solid State Ignition (Incl. 101)
101	610118	1	Spark Plug Cover
103	650814	2	Screw, Torx T-15, 10-24 x 1"
105A	650796	4	Stud
110	611129	1	Ground Wire
119	510274A	1	* Cylinder Head Gasket
120	250240B	1	Cylinder Head
131	650477	5	Screw, Torx T-30, 1/4-20 x 3/4"
135	611049	1	Resistor Spark Plug (RCJ8Y)
163	650838	1	Washer
169	510325A	1	* Compression Release Cover Gasket
172A	570708	1	Compression Release Cover
174	650579	1	Screw, Torx T-25, 10-24 x 1/2"
177	650959	2	Screw, 5/32 Allen, 1/4-20 x 1"
184	510326A	2	* Carburetor Gasket
186	490322	1	Governor Link
187	570438A	1	Spacer
216	570645	1	R.P.M. Adjusting Lever
257	650911	4	Screw, Torx T-30, 1/4-20 x 5/8"
258	350422	1	Blower Housing Base (Incl. 75)
260	350424	1	Blower Housing
261	650737	4	Screw, 1/4-20 x 1/2"
274	510207A	1	* Exhaust Gasket
277	650869	2	Screw, 1/4-20 x 2-3/4"
285	590551	1	Starter Cup
287	xxxxx	4	Rivet (Can be purchased locally)
325	29443	1	Wire Clip
370	35977	1	Instruction Decal
380	632396A	1	Carburetor (Incl. 184)
390	590537	1	Rewind Starter
400	510324B	1	* Gasket Set (Incl. items marked PK i n notes) Incl. (1) each of part #'s 510207A, 510274A, 510292A, 510323A, 510325A, 510326A, 510346A, and (2) of part # 510110A

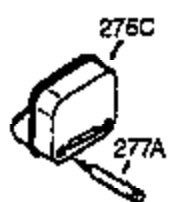
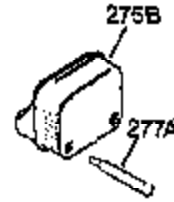
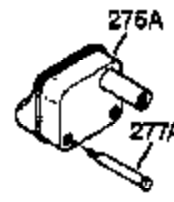
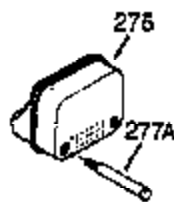
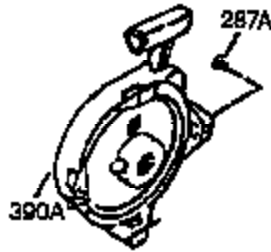
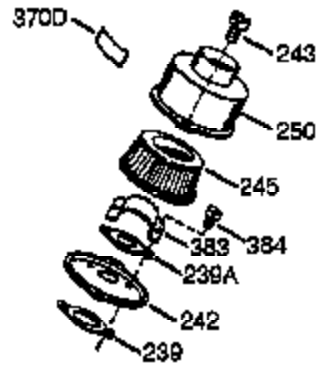
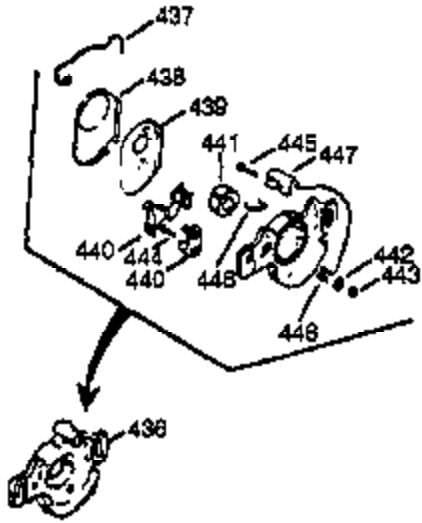

Ref #	Part Number	Qty	Description
275	390330	1	Muffler (Incl. 274 & 277)
420	730227A	1	2-Cycle Oil (8 oz.)
