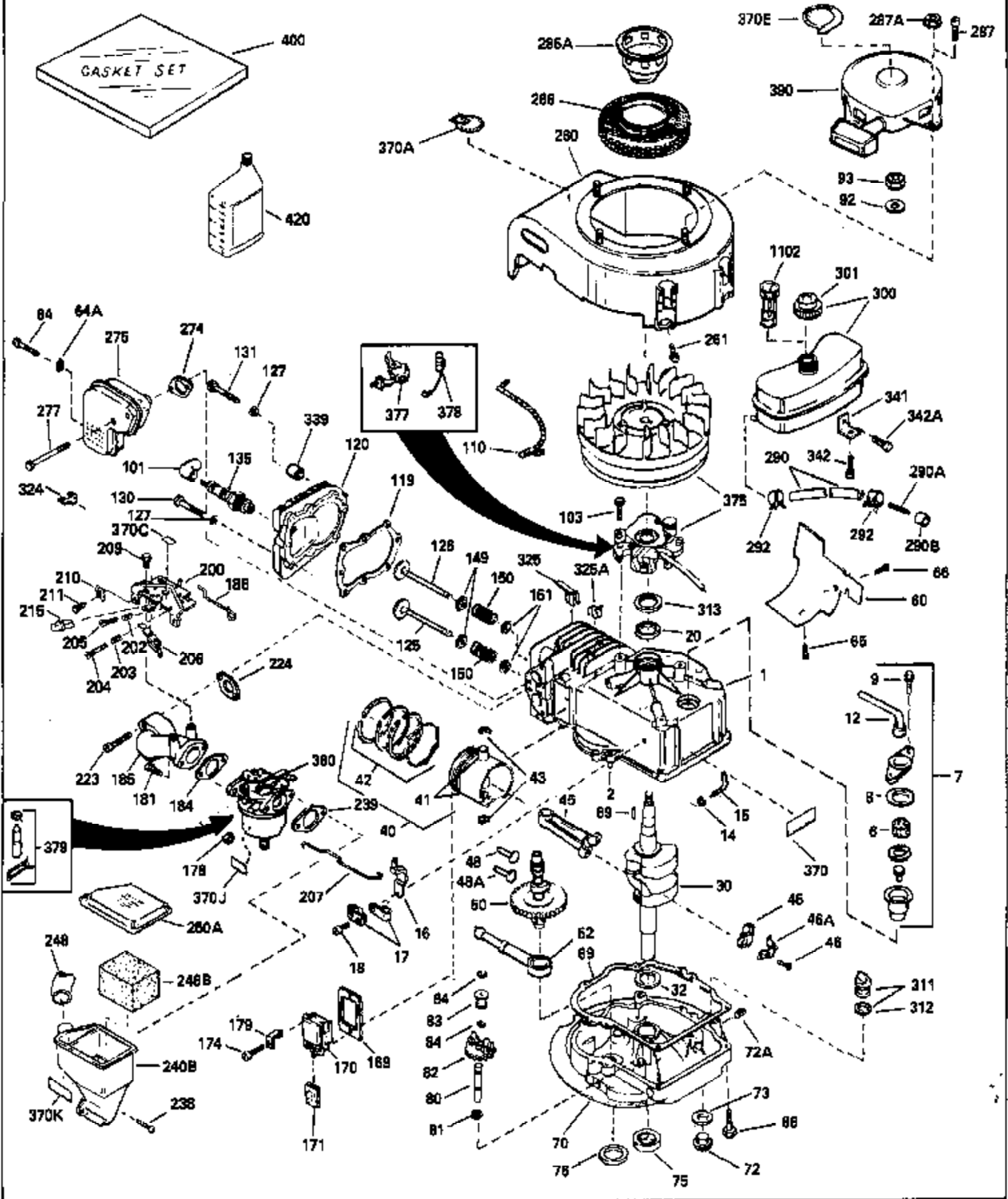

ILLUSTRATION SHOWS TYPICAL PARTS ONLY. ORDER BY PART NUMBER. PARTS NOT LISTED ARE SUPPLIED BY OEM.



Ref #	Part Number	Qty	Description
1	32601A		Cylinder (Incl. 2, 20, 119 & 120) (2- 5/8")
2	26727		Pin, Dowel
14	28277		Washer, Flat
15	30589		Rod, Governor (Incl. 14)
16	32651		Lever, Governor
17	31335		Clamp, Governor lever (Clamp is positioned towardspark plug end on 1977-78 and latermodels. It is positioned opposite spark plugend on earlier models.)
18	650548		Screw, 8-32 x 5/16"
19	31386		Spring, Governor
20	32600		Seal, Oil
30	32602A		Crankshaft (Incl. 45)
32	32323		Washer, Thrust
40	34851		Piston, Pin & Ring Set (Std.) (2-5/8" Bore)
40	34852		Piston, Pin & Ring Set (.010" OS)
40	34853		Piston, Pin & Ring Set (.020" OS)
41	32603B		Piston & Pin Ass'y.(Std.)(Incl. 43)(2 -5/8")
41	32604B		Piston & Pin Ass'y. (.010" OS) (Incl. 43)
41	32605B		Piston & Pin Ass'y. (.020" OS) (Incl. 43)
42	34854		Ring Set (Std.) (2-5/8" Bore)
42	34855		Ring Set (.010" OS)
42	34856		Ring Set (.020" OS)
43	20381		Ring, Piston pin retaining
45	32875		Rod Assy., Connecting (Incl. 18)
46A	32609		Plate, Lock (Do not use with 32610A locking type screw)
46	32610		Connecting Rod Bolt (Early Production )
46	32610A		Bolt, Connecting rod
48	27241		Lifter, Exhaust valve
48A	32646		Lifter, Intake valve
50	32647		Camshaft (MCR)
52	29914		Pump Assy., Oil
60	29745		Extension, Blower housing
65	650128		Screw, 10-24 x 1/2"
66	30063		Screw, Torx T-30, 1/4-20 x 1/2"
69	35261		* Gasket, Mounting flange
70	32612A		Flange Ass'y. (Incl. 72, 75 & 80)
72	30572		Plug, Oil drain (Incl. 73)
72A	9556		Oil Drain Plug (Use as required)
73	28833		* Drain Plug Gasket (Do not use w/plastic plug)
75	27897		Seal, Oil
80	30574		Shaft, Mechanical governor
81	30590A		Washer, Flat
82	30591		Gear Assy., Governor (Incl. 81)
83	30588A		Spool, Governor
84	29193		Ring, Retaining
86	650488		Screw, 1/4-20 x 1-1/4"
89	610951		Key, Flywheel
92	650815		Washer, Belleville
93	650607		Nut, Flywheel
103	650489		Screw, 1/4-20 x 5/8"
110	35349		Ground Wire
119	32643A		* Gasket, Cylinder head
120	30579A		Head, Cylinder (Incl. 131)
125	32644A		Intake Valve (STD)(Incl.151) (Inverted Ports)
125	32645A		Intake Valve (1/32" OS)(Incl.151) (Inverted Ports)
126	29313C		Exhaust Valve (STD)(Incl. 151) (Inverted Ports)
126	29315C		Exhaust Valve (1/32" OS)(Incl. 151) (Inverted Ports)

Ref #	Part Number	Qty	Description
127	26073		Washer (Not used in late production)
127	650691		Washer (Used on late production)
130	6021A		Screw, 5/16-18 x 1-1/2" (Use as requi red)
130	650818		Screw, 5/16-18 x 1-1/2" (Use as requi red)
131	650694A		Screw, 5/16-18 x 2" (Use as required)
131	650697A		Screw, 5/16-18 x 2-1/2" (Use as requi red)
135	33636		Spark Plug (J-8C)
149	31671		Valve Spring Cap) (Used in early prod uction)
150	31672		Spring, Valve
151	31673		Cap, Lower valve spring
169	31619A		* Gasket, Valve spring cover
170	31337A		Body Assy., Breather (Incl. 169 & 171 )
171	31410		Element, Breather
174	650128		Screw, 10-24 x 1/2"
178	29752		Nut & Lockwasher, 1/4-28
181	6201		Screw, 1/4-28 x 7/8"
182	6201		Screw, 1/4-28 x 7/8"
184	31688A		* Gasket, Carburetor
185	32650		Pipe, Intake
186	32653		Link, Governor spring
200	32181A		Control Bracket (Incl. 203, 204 & 206 )
203	31342		Spring, Compression
204	650549		Screw, 5-40 x 7/16"
206	610973		Terminal Assy.
207	32652		Link, Governor-to-throttle
209	30200		Screw, 10-24 x 9/16"
210	27793		Clip, Conduit
211	28942		Screw, 10-32 x 3/8"
223	650664		Screw, 1/4-20 x 1-19/32"
224	32649A		* Gasket, Intake
238	28820		Screw, 10-32 x 1/2"
239	27272A		* Gasket, Air cleaner
260	32455B		Housing, Blower NOTE: Replacement hardware may differ when servicing starter assy. or blower housing. Refer to Service Bulletin 508.
261	650561		Screw, 1/4 20 x 5/8"
274	26754A		* Gasket, Exhaust
275	35771		Muffler (Incl. 274)
277	30063		Screw, Torx T-30, 1/4-20 x 1/2" (Use as req.)
285A	590416		Cup, Starter
286	590417		Screen, Starter cup
287	29716		Screw, 1/4-28 x 7/16" (Use as require d)
287	30513		Screw & Lockwasher, 1/4-28 x 1/2"
287			Pop Rivet (Purchase locally) (3/16" d ia.)
287A	29752		Nut & Lockwasher, 1/4-28 (Use as requ ired)
290	29774		Fuel Line(Braided 8-1/4")(21 cm)(Use as req.)
290	34357		Fuel Line (Epichlorohydrin 6-3/4") (1 7 cm)
290	30705		Fuel Line (Braided 16")(40 cm)(Use as req.)
290B	29774		Connector, Fuel line (Braided 8-1/4") (21cm)
290A	31400		Fuel Line (Metal 3-3/8")
292	26460		Fuel Line Clamp (Use as required)
300	32671		Fuel Tank (Incl. 292 & 301)
301	410144B		Fuel Cap (Std.) (Use as required)
301	33032		Fuel Cap (Use as required)
301	34210		Fuel Cap (use as required)
311	27625		Plug, Oil filler (Incl. 312)
312	29673		* Gasket, Oil filler

Ref #	Part Number	Qty	Description
325A	27275		Clip, Hi-tension wire (Use as require d)
370C	35344		Decal, Speed control
370	34346		Decal, Instruction
370A	550223		Name & Instruction Decal
375	610755		Magneto (W/Ring Gear) NOTE: This magneto is not available as an assembly. The magneto number is shown for reference purposes only. Order component parts individually, as shown in parts breakdown. Refer to Division 5, Section B, page24 or Fiche 6, Grid F-11 for breakdown)
377	30547A		Contact Assy., Breaker
378	30548B		Condenser
379	631021		Inlet Needle, Seat & Clip Assy.
380	631452		Carburetor (Incl. 184) Refer to Division 5, SectionA, page 100 or Fiche 6, Grid D-13 for breakdown)
390	590420A		Rewind Starter NOTE: Replacement hardware may differ when servicing starter assy. or blower housing. Refer to Service Bulletin 508. (Refer to Division 5, Section C, page 25 or Fiche 6, Grid G-3 for breakdown)
400	33238D		* Gasket Set (Incl. items marked *)
420	730225		SAE 30 4-Cycle Engine Oil (Quart)

ILLUSTRATION SHOWS TYPICAL PARTS ONLY. ORDER BY PART NUMBER. PARTS NOT LISTED ARE SUPPLIED BY OEM.

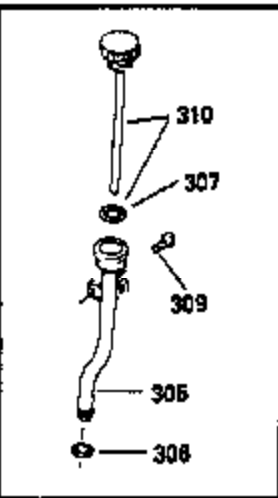
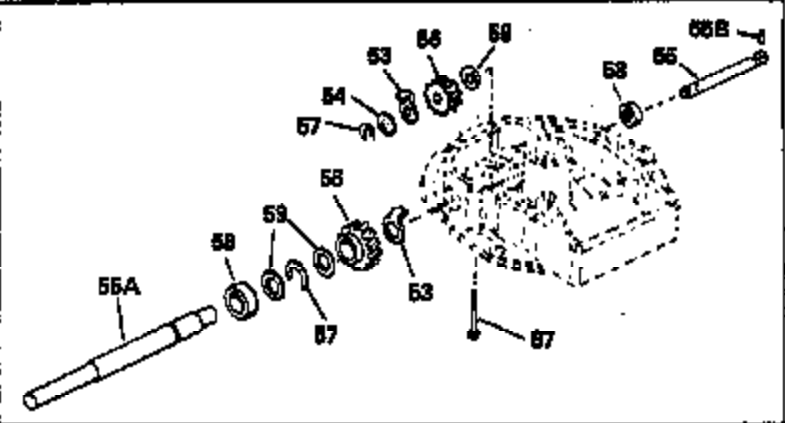
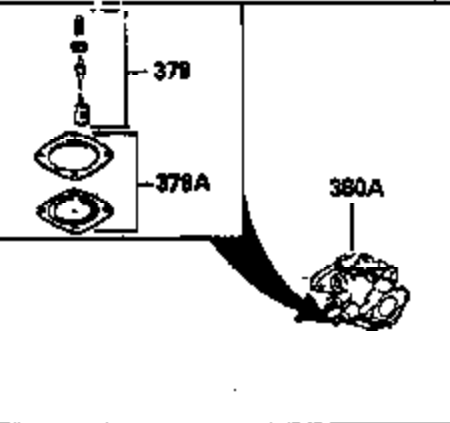
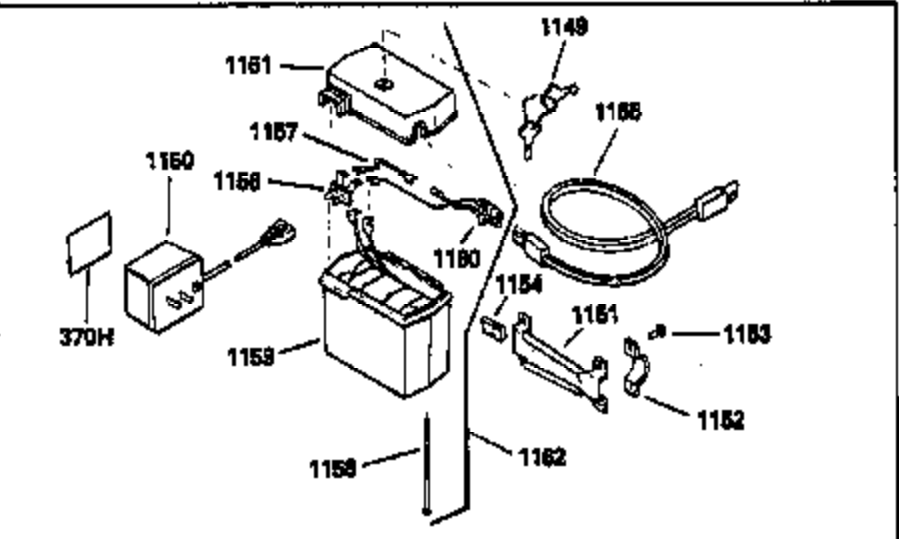
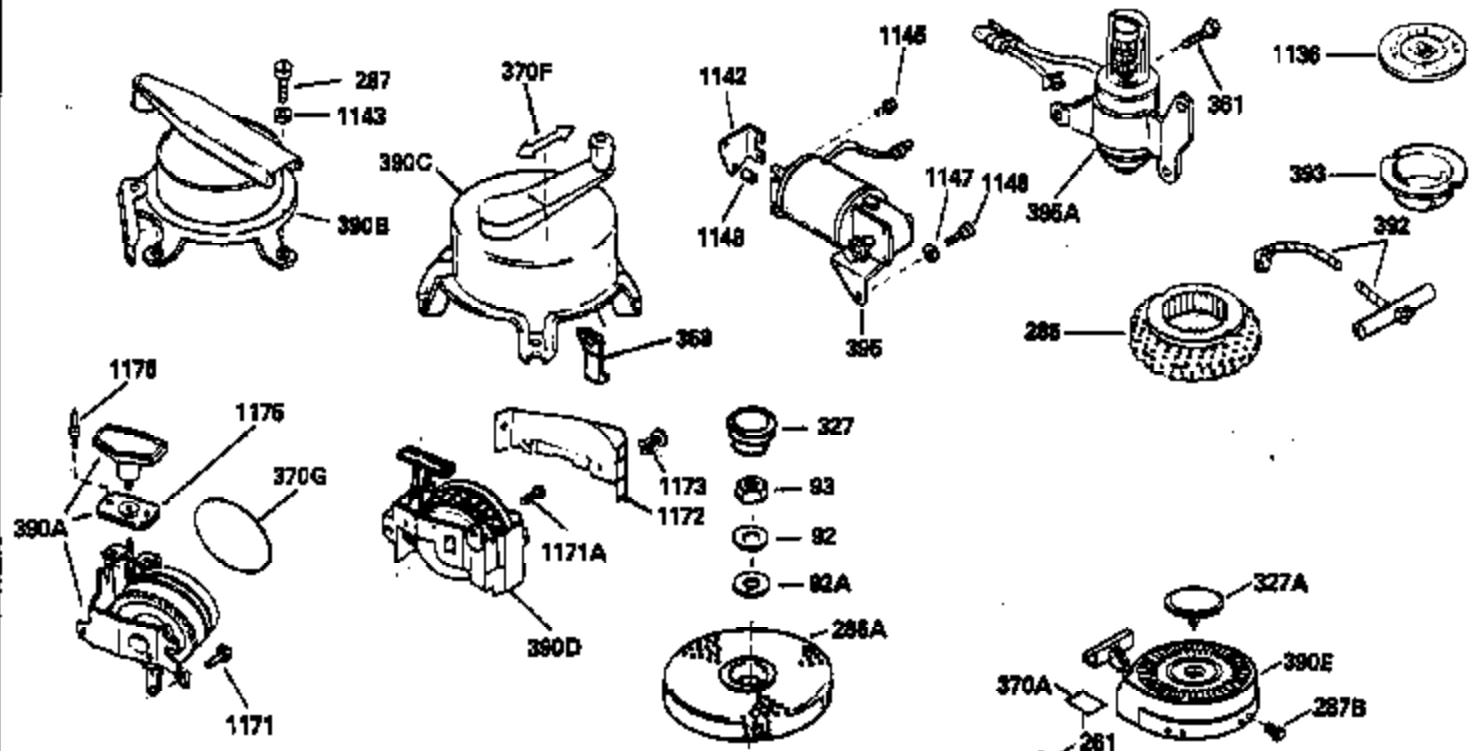

Ref #	Part Number	Qty	Description
19	31386		Spring, Governor
32	32323		Washer, Thrust
92	650815		Washer, Belleville
93	650607		Nut, Flywheel
182	6201		Screw, 1/4-28 x 7/8"
261	650561		Screw, 1/4 20 x 5/8"
262	650561		Screw, 1/4-20 x 5/8"
287	29716		Screw, 1/4-28 x 7/16" (Use as require d)
287	30513		Screw & Lockwasher, 1/4-28 x 1/2"
287			Pop Rivet (Purchase locally) (3/16" d ia.)
306	34282		"O" Ring (This "O" ring is required with metal fill tube only when replacement mounting flange with .777 dia. oil fill hole has been used.)
370A	550223		Name & Instruction Decal
370	34346		Decal, Instruction
379	631021		Inlet Needle, Seat & Clip Assy.
1175	590441		Bracket Ass'y. (Use as required)
1176	650639		Open End Rivet (Use as required)

ILLUSTRATION SHOWS TYPICAL PARTS ONLY. ORDER BY PART NUMBER. PARTS NOT LISTED ARE SUPPLIED BY OEM.

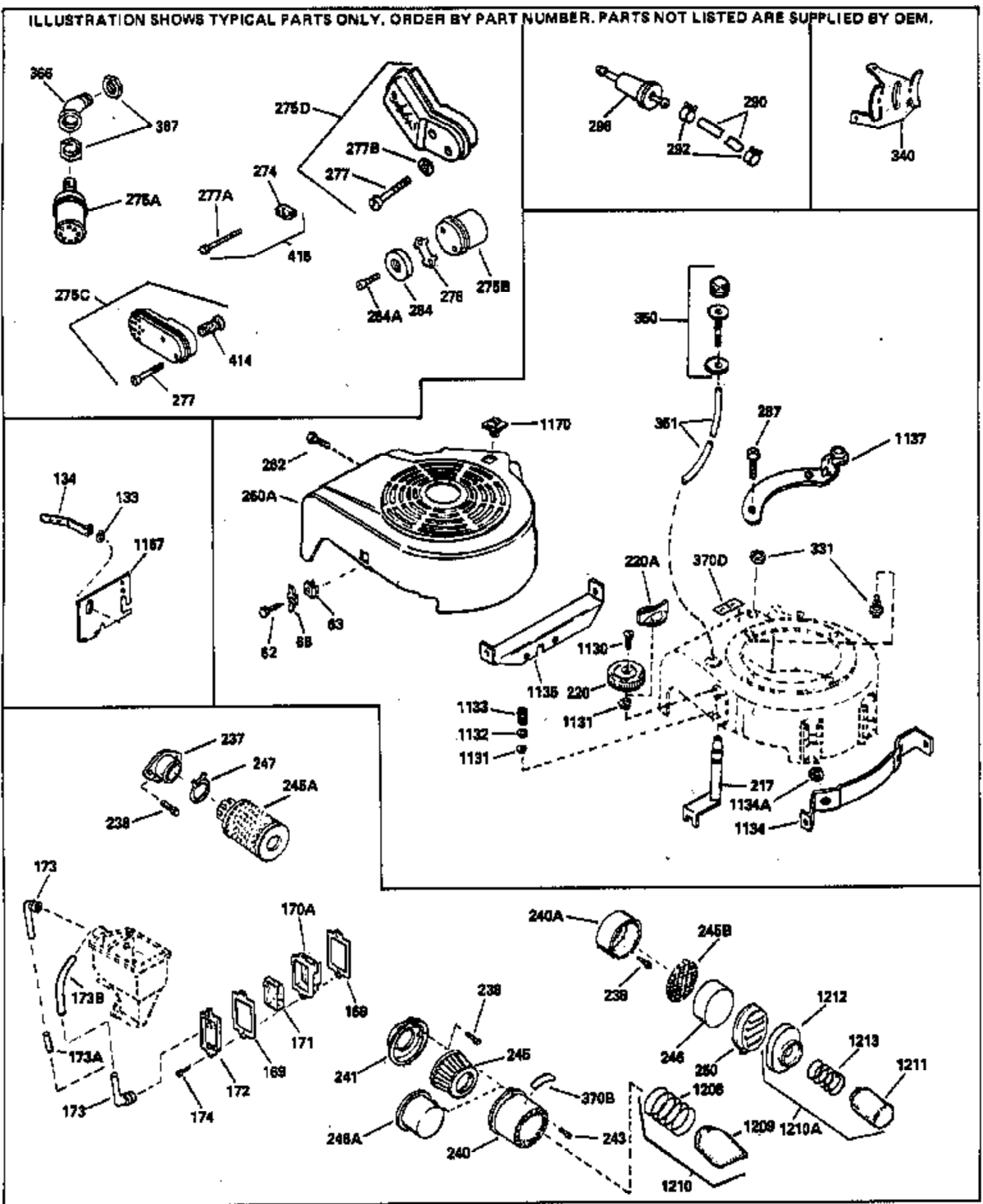

Ref #	Part Number	Qty	Description
19	31386		Spring, Governor
32	32323		Washer, Thrust
169	31619A		* Gasket, Valve spring cover
171	31410		Element, Breather
174	650128		Screw, 10-24 x 1/2"
182	6201		Screw, 1/4-28 x 7/8"
238	28820		Screw, 10-32 x 1/2"
240	31715		Body, Air cleaner
241	31691		Bracket, Air cleaner
243	650152		Screw, 8-32 x 3/8"
245	30727		Air Cleaner Filter
262	650561		Screw, 1/4-20 x 5/8"
274	26754A		* Gasket, Exhaust
277	30063		Screw, Torx T-30, 1/4-20 x 1/2" (Use as req.)
277A	650774		Screw, 1/4-20 x 2-3/8"
287	29716		Screw, 1/4-28 x 7/16" (Use as require d)
287	30513		Screw & Lockwasher, 1/4-28 x 1/2"
287			Pop Rivet (Purchase locally) (3/16" d ia.)
290	29774		Fuel Line(Braided 8-1/4")(21 cm)(Use as req.)
290	34357		Fuel Line (Epichlorohydrin 6-3/4") (1 7 cm)
290	30705		Fuel Line (Braided 16")(40 cm)(Use as req.)
292	26460		Fuel Line Clamp (Use as required)
370B	31752		Decal, Air cleaner
415	730162		Muffler Adapter Kit (Incl. 274 & 277A ) (Inverted Ports)