

ILLUSTRATION SHOWS TYPICAL PARTS ONLY. ORDER BY PART NUMBER. PARTS NOT LISTED ARE SUPPLIED BY OEM.



Ref #	Part Number	Qty	Description
1	35010		Cylinder (Incl. 2 & 20) (2-5/8" Bore)
2	26727		Pin, Dowel
14	28277		Washer, Flat
15	30589		Rod, Governor (Incl. 14)
16	31383A		Lever, Governor
17	31335		Clamp, Governor lever (Clamp is positioned towardspark plug end on 1977-78 and latermodels. It is positioned opposite spark plugend on earlier models.)
18	650548		Screw, 8-32 x 5/16"
19	31361		Spring, Governor
20	32600		Seal, Oil
30	34187		Crankshaft
32	32323		Washer, Thrust
40	34851		Piston, Pin & Ring Set (Std.) (2-5/8" Bore)
40	34852		Piston, Pin & Ring Set (.010" OS)
40	34853		Piston, Pin & Ring Set (.020" OS)
41	32603B		Piston & Pin Ass'y.(Std.)(Incl. 43)(2 -5/8")
41	32604B		Piston & Pin Ass'y. (.010" OS) (Incl. 43)
41	32605B		Piston & Pin Ass'y. (.020" OS) (Incl. 43)
42	34854		Ring Set (Std.) (2-5/8" Bore)
42	34855		Ring Set (.010" OS)
42	34856		Ring Set (.020" OS)
43	20381		Ring, Piston pin retaining
45	32875		Rod Assy., Connecting (Incl. 18)
46	32610		Connecting Rod Bolt (Early Production )
46	32610A		Bolt, Connecting rod
46A	32609		Plate, Lock (Do not use with 32610A locking type screw)
48	27241		Lifter, Exhaust valve
48A	27241		Lifter, Intake valve
50	33148A		Camshaft
52	29914		Pump Assy., Oil
60	29745		Extension, Blower housing
66	30063		Screw, Torx T-30, 1/4-20 x 1/2"
69	35261		* Gasket, Mounting flange
70	34311C		Mounting Flange Ass'y. (Incl. 72, 75 & 80)
72	30572		Plug, Oil drain (Incl. 73)
72A	9556		Oil Drain Plug (Use as required)
73	28833		* Drain Plug Gasket (Do not use w/plastic plug)
75	27897		Seal, Oil
80	30574		Shaft, Mechanical governor
81	30590A		Washer, Flat
82	30591		Gear Assy., Governor (Incl. 81)
83	30588A		Spool, Governor
84	29193		Ring, Retaining
86	650488		Screw, 1/4-20 x 1-1/4"
89	610951		Key, Flywheel
92	650815		Washer, Belleville
93	650607		Nut, Flywheel
103	650489		Screw, 1/4-20 x 5/8"
110	34231		Ground Wire
119	33015A		* Gasket, Cylinder head
120	33016A		Head, Cylinder (Incl. 131)
125	29313C		Exhaust Valve (STD)(Incl. 151) (Conventional Ports)
125	29315C		Exhaust Valve (1/32" OS)(Incl. 151) (Conventional Ports)
126	29314B		Intake Valve (STD)(Incl. 151) (Conventional Ports)
126	29315C		Intake Valve (1/32" OS)(Incl. 151) (Conventional Ports)
127	26073		Washer (Not used in late production)

Ref #	Part Number	Qty	Description
127	650691		Washer (Used on late production)
130	6021A		Screw, 5/16-18 x 1-1/2" (Use as required)
130	650818		Screw, 5/16-18 x 1-1/2" (Use as required)
131	650694A		Screw, 5/16-18 x 2" (Use as required)
131	650697A		Screw, 5/16-18 x 2-1/2" (Use as required)
135	33636		Spark Plug (J-8C)
149	31671		Valve Spring Cap (Used in early production)
150	31672		Spring, Valve
151	31673		Cap, Lower valve spring
169	31619A		* Gasket, Valve spring cover
170	31337A		Body Assy., Breather (Incl. 169 & 171 )
171	31410		Element, Breather
174	650128		Screw, 10-24 x 1/2"
178	29752		Nut & Lockwasher, 1/4-28
179	30593		Clip, Magneto wire
181	6201		Screw, 1/4-28 x 7/8"
182	6201		Screw, 1/4-28 x 7/8"
184	26756		* Gasket, Carburetor
185	31384A		Pipe, Intake (Incl. 224)
186	33151		Link, Governor spring
200	33131A		Control Bracket (Incl. 203 thru 206)
202	33802		Spring, Compression
203	31342		Spring, Compression
204	650549		Screw, 5-40 x 7/16"
205	650777		Screw, 6-32 x 21/32"
206	610973		Terminal Assy.
207	33133		Link, Governor-to-throttle
209	30200		Screw, 10-24 x 9/16"
210	27793		Clip, Conduit
211	28942		Screw, 10-32 x 3/8"
223	650451		Screw, 1/4-20 x 1"
224	32649A		* Gasket, Intake
238	650709		Screw, 10-32 x 7/16"
239	27272A		* Gasket, Air cleaner
260	34076		Blower Housing NOTE: Replacement hardware may differ when servicing starter Assy. or blower housing. Refer to Service Bulletin 508.
261	650561		Screw, 1/4 20 x 5/8"
277	30063		Screw, Torx T-30, 1/4-20 x 1/2" (Use as req.)
277	650795		Screw, 1/4-20 x 2-1/4"
287	30513		Screw & Lockwasher, 1/4-28 x 1/2"
287			Pop Rivet (Purchase locally) (3/16" d ia.)
287	29716		Screw, 1/4-28 x 7/16" (Use as required)
287A	29752		Nut & Lockwasher, 1/4-28 (Use as required)
290A	31400		Fuel Line (Metal 3-3/8")
290	29774		Fuel Line(Braided 8-1/4")(21 cm)(Use as req.)
290	34357		Fuel Line (Epichlorohydrin 6-3/4") (1 7 cm)
290	30705		Fuel Line (Braided 16")(40 cm)(Use as req.)
290B	29774		Connector, Fuel line (Braided 8-1/4") (21cm)
292	26460		Fuel Line Clamp (Use as required)
300	33882		Fuel Tank (Incl. 102)
301	410144B		Fuel Cap (Std.) (Use as required)
301	33032		Fuel Cap (Use as required)
301	34210		Fuel Cap (use as required)
305	32750		Oil Fill Tube
313	33876		Gasket, Stator
325A	27275		Clip, Hi-tension wire (Use as required)

Ref #	Part Number	Qty	Description
375	610964		Magneto (W/Ring Gear) NOTE: This magneto is not available as an assembly. The magneto number is shown for reference purposes only. Order component parts individually, as shown in parts breakdown. Refer to Division 5, Section B, page35 or Fiche 6, Grid F-13 for breakdown)
377	30547A		Contact Assy., Breaker
378	30548B		Condenser
379	631021		Inlet Needle, Seat & Clip Assy.
380	631699		Carburetor (Incl. 184) (Refer to Division 5, Section A, page 112 or Fiche 6, Grid E-5 for breakdown)
400	33238D		* Gasket Set (Incl. items marked *)
420	730225		SAE 30 4-Cycle Engine Oil (Quart)

ILLUSTRATION SHOWS TYPICAL PARTS ONLY. ORDER BY PART NUMBER. PARTS NOT LISTED ARE SUPPLIED BY OEM.

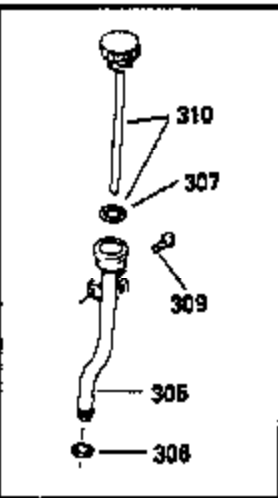
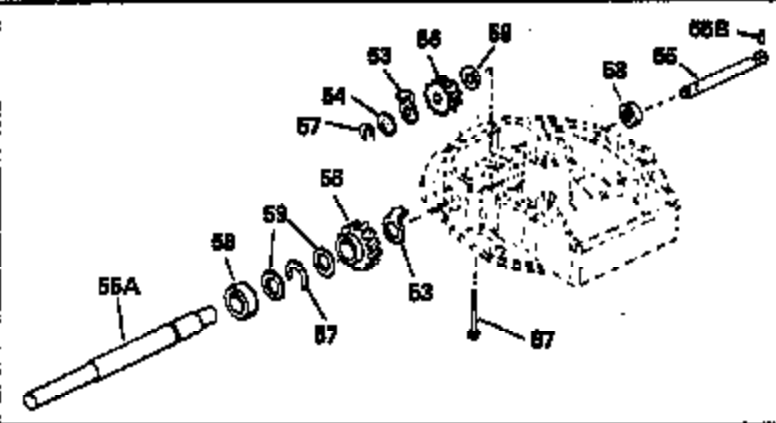
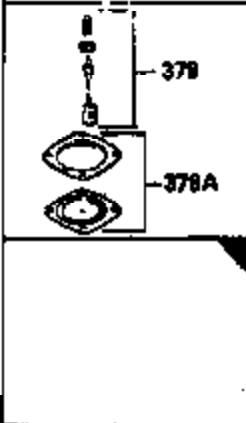
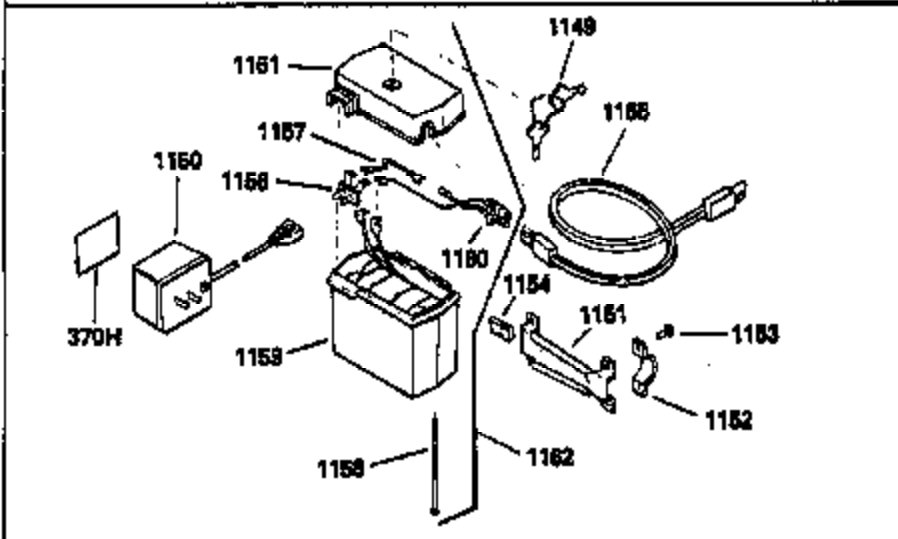
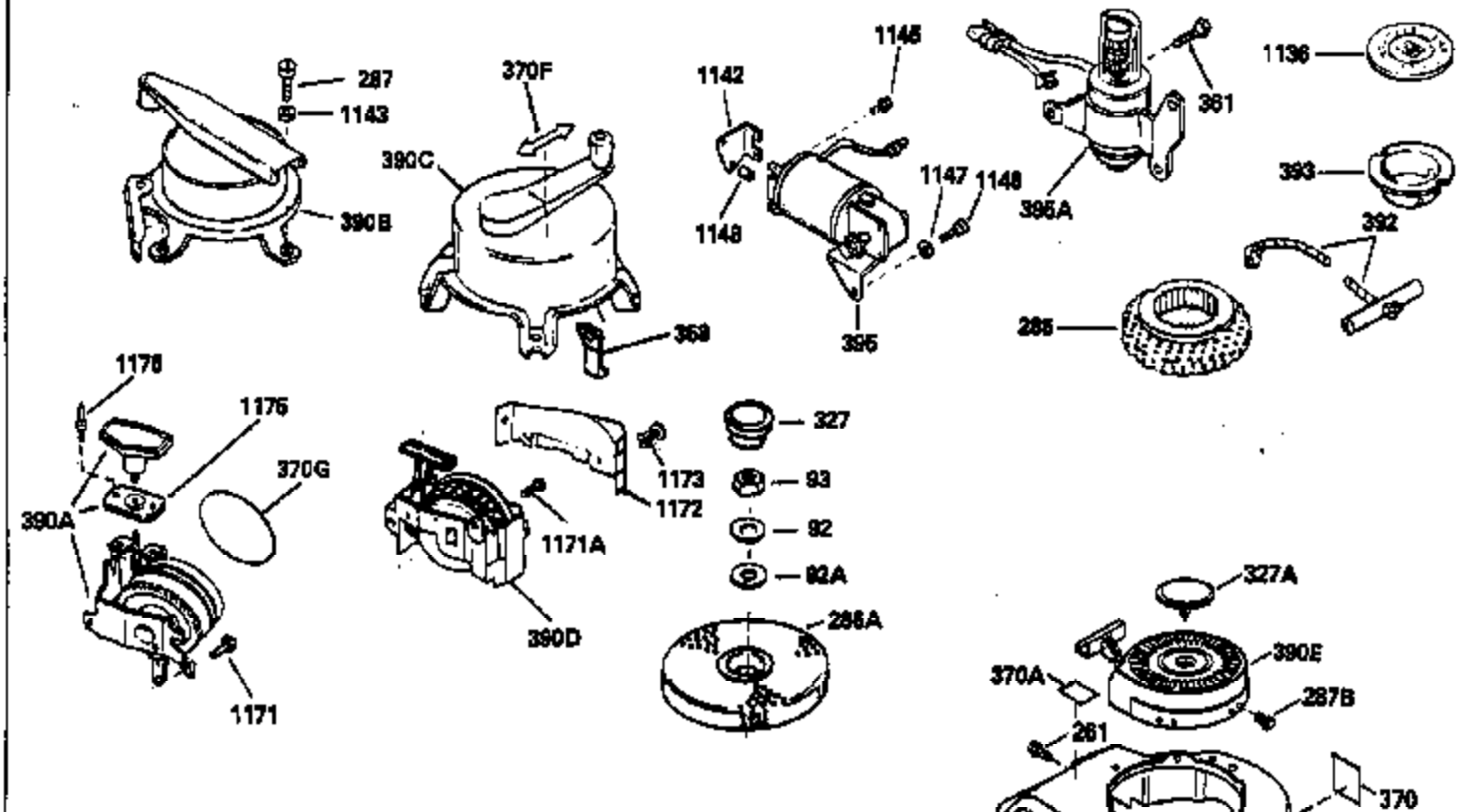

Ref #	Part Number	Qty	Description
19	31361		Spring, Governor
32	32323		Washer, Thrust
92	650815		Washer, Belleville
93	650607		Nut, Flywheel
182	6201		Screw, 1/4-28 x 7/8"
261	650561		Screw, 1/4 20 x 5/8"
262	650561		Screw, 1/4-20 x 5/8"
286A	32237		Screen, Flywheel
287	30513		Screw & Lockwasher, 1/4-28 x 1/2"
287			Pop Rivet (Purchase locally) (3/16" d ia.)
287	29716		Screw, 1/4-28 x 7/16" (Use as require d)
305	32750		Oil Fill Tube
306	34282		"O" Ring (This "O" ring is required with metal fill tube only when replacement mounting flange with .777 dia. oil fill hole has been used.)
306	30139		"O" Ring
307	29985		"O" Ring
309	650562		Screw, 10-32 x 1/2"
310	34227		Dipstick (Incl. 307)
327	32236		Plug, Screen
379	631021		Inlet Needle, Seat & Clip Assy.
390A	590450A		Side Mount Rewind Starter NOTE: Replacement hardware may differ when servicing starter assy. or blower housing. Refer to Service Bulletin 508. (Refer to Division 5, Section C, page 27 or Fiche 6, Grid G-4 for breakdown)
1171	650737		Screw, 1/4-20 x 1/2"
1175	590441		Bracket Ass'y. (Use as required)
1176	650639		Open End Rivet (Use as required)

ILLUSTRATION SHOWS TYPICAL PARTS ONLY. ORDER BY PART NUMBER. PARTS NOT LISTED ARE SUPPLIED BY OEM.

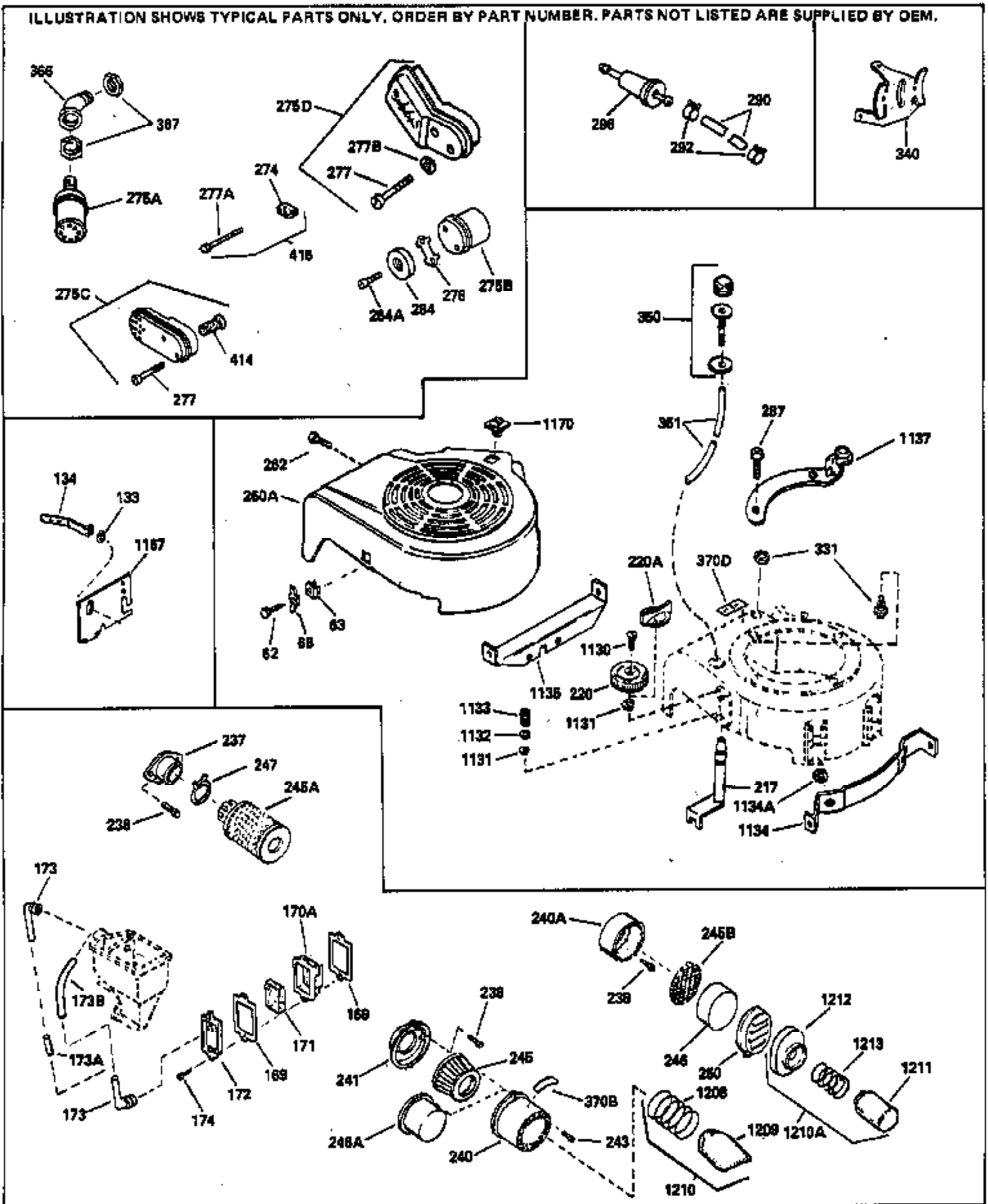

Ref #	Part Number	Qty	Description
19	31361		Spring, Governor
32	32323		Washer, Thrust
169	31619A		* Gasket, Valve spring cover
171	31410		Element, Breather
174	650128		Screw, 10-24 x 1/2"
182	6201		Screw, 1/4-28 x 7/8"
237	32971		Adapter, Air cleaner
238	650709		Screw, 10-32 x 7/16"
245A	32972		Air Cleaner Filter
247	33168		Clamp, Corbin
262	650561		Screw, 1/4-20 x 5/8"
275B	27181B		Muffler (Incl. 274 & 277)
277	30063		Screw, Torx T-30, 1/4-20 x 1/2" (Use as req.)
277	650795		Screw, 1/4-20 x 2-1/4"
287	30513		Screw & Lockwasher, 1/4-28 x 1/2"
287			Pop Rivet (Purchase locally) (3/16" d ia.)
287	29716		Screw, 1/4-28 x 7/16" (Use as require d)
290	29774		Fuel Line(Braided 8-1/4")(21 cm)(Use as req.)
290	34357		Fuel Line (Epichlorohydrin 6-3/4") (1 7 cm)
290	30705		Fuel Line (Braided 16")(40 cm)(Use as req.)
292	26460		Fuel Line Clamp (Use as required)
305	32750		Oil Fill Tube
415	730162		Muffler Adapter Kit (Incl. 274 & 277A ) (Inverted Ports)