

Ref #	Part Number	Qty	Description
	1 37791	1	Cylinder (Incl. 2 & 20)
	2 26727	2	Dowel Pin
	6 33734	1	Breather Element
	7 36557	1	Breather Ass'y. (Incl. 6 & 12A)
	12 32447	1	Breather Tube
	12A 36558	1	Breather Cover & Tube
	12B 36694	1	Breather Tube Elbow
	14 28277	1	Washer
	15 30589	1	Governor Rod (Incl. 14)
	16 34839A	1	Governor Lever
	17 31335	1	Governor Lever Clamp
	18 651018	1	Screw, T-15, 8-32 x 19/64"
	19 33578	1	Extension Spring
	20 32600	1	Oil Seal
	30 37810	1	Crankshaft
	40 40053	1	Piston, Pin & Ring Set (Std.)
	41 40051	1	Piston & Pin Ass'y. (Std.) (Incl. 43)
	42 40022	1	Ring Set (Std.)
	43 20381	2	Piston Pin Retaining Ring
	45 30963B	1	Connecting Rod Ass'y. (Incl. 46)
	46 32610A	2	Connecting Rod Bolt
	48 27241	2	Valve Lifter
	50 37575	1	Camshaft (NCR)(Incl. 104)
	52 29914	1	Oil Pump Ass'y.
	69 37609	1	* Mounting Flange Gasket
	70 37608	1	Mounting Flange (Incl. 72-83,306,309A & 311A)
	72 37614	1	Oil Drain Plug
	75 27897	1	Oil Seal
	80 30574A	1	Governor Shaft
	81 30590A	1	Washer
	82 30591	1	Governor Gear Ass'y. (Incl. 81)
	83 30588A	1	Governor Spool
	86 650488	6	Screw, 1/4-20 x 1-1/4"
	89 611004	1	Flywheel Key
	90 611112	1	Flywheel
	92 650815	1	Belleville Washer
	93 650816	1	Flywheel Nut
	100 34443C	1	Solid State Ignition
	101 610118	1	Spark Plug Cover
	103 651007	2	Screw, T-15, 10-24 x 15/16"
	104 37480	1	Cam Bushing
	110 37047	1	Ground Wire
	119 37755	1	* Cylinder Head Gasket
	120 37807	1	Cylinder Head
	125 37806	1	Exhaust Valve (Std.) (Incl. 151)
	126 37805	1	Intake Valve (Std.) (Incl. 151)
	130 6021A	8	Screw, 5/16-18 x 1-1/2"
	135 35395	1	Resistor Spark Plug (RJ19LM)
	150 31672	2	Valve Spring
	151A 40016A	1	Intake Valve Seal
	151 31673	2	Valve Spring Cap
	169 36783	1	* Valve Cover Gasket
	172 36784	1	Valve Cover
	174 30200	2	Screw, 10-24 x 9/16"
	178 29752	2	Nut & Lock Washer, 1/4-28
	182 6201	2	Screw, 1/4-28 x 7/8"
	184 26756	1	* Carburetor To Intake Pipe Gasket
	185 37794	1	Intake Pipe

Ref #	Part Number	Qty	Description
186	32653	1	Governor Link
189	650839	2	Screw, 1/4-20 x 3/8"
191	36559A	1	S.E. Brake Bracket (Incl. 195)
195	610973	1	Terminal
207	34336A	1	Throttle Link
216	33086	1	R.P.M. Adjusting Lever
223	650451	2	Screw, 1/4-20 x 1"
224	37793	1	* Intake Pipe Gasket
238	650932	2	Screw, 10-32 x 49/64"
239	34338	1	* Air Cleaner Gasket
245	35066	1	Air Cleaner Filter
250	35986	1	Air Cleaner Cover (Craftsman)
260	37811	1	Blower Housing
261	30200	2	Screw, 10-24 x 9/16"
262	650831	2	Screw, 1/4-20 x 1/2"
275	37192A	1	Muffler
277	650988	2	Screw, 1/4-20 x 2-5/16"
285	35000A	1	Starter Cup
287	650926	2	Screw, 8-32 x 21/64"
290	29774	1	Fuel Line
292	26460	2	Fuel Line Clamp
300	35586A	1	Fuel Tank (Incl. 292 & 301)
301	36246	1	Fuel Cap
305	35647	1	Oil Fill Tube
306	37610	1	* "O" Ring
307	35499	1	"O" Ring
309	650562	1	Screw, 10-32 x 1/2"
309A	650783	1	Screw, 10-24 x 3/4"
310	35648	1	Dipstick
311A	37611	1	Hold Down Bracket
313	34080	1	Spacer
370C	37318	1	Primer Decal (3X)
370K	36695	1	Starter Decal
380	640339	1	Carburetor (Incl. 184)
390	590737	1	Rewind Starter (NOTE: This engine could have been built with 590694 starter.)
400	37809	1	* Gasket Set (Incl. items marked PK in notes)
420	730225A	1	SAE 30 4-Cycle Engine Oil (Quart)

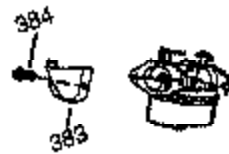
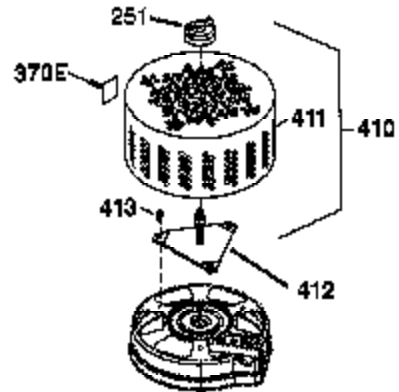
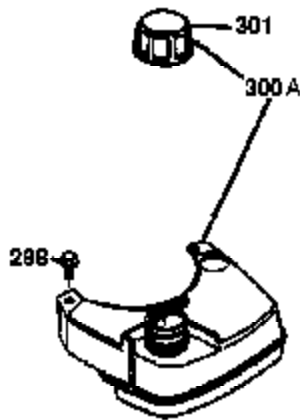
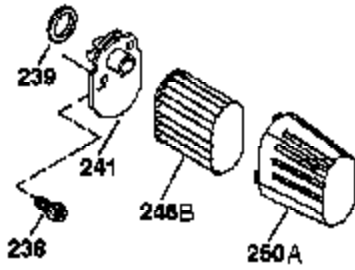
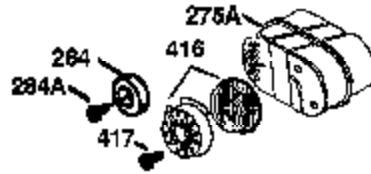
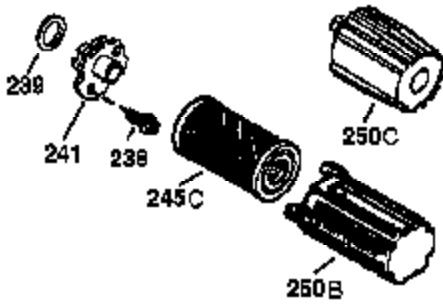

Ref #	Part Number	Qty	Description
238	650932	2	Screw, 10-32 x 49/64"
239	34338	1	* Air Cleaner Gasket
241	35797	1	Air Cleaner Collar
275A	36838A	1	Spark Arrestor Muffler (Optional) (Incl. 284,284A,416 & 417)
284	36663	1	Muffler Deflector (Incl. 284A)(Optional)
284A	650821	1	Screw, 10-32 x 1/2" (Optional)
298	28763	3	Screw, 10-32 x 39/64"
301	36246	1	Fuel Cap
416	37530	1	Spark Arrestor Kit (Incl. 417)(Optional)
417	650821	1	Screw, 10-32 x 1/2" (Optional)