

Ref #	Part Number	Qty	Description
1	35385	1	Cylinder (Incl. 2, 20 & 72)
2	27652	2	Dowel Pin
3	650820	2	Screw, 1/4-20 x 1/2"
14	28277	1	Washer
15A	30700	1	Governor Yoke
15	30699C	1	Governor Rod (Incl. 15A & 15B)
15B	650494	1	Screw, 6-40 x 5/16"
16	33454A	1	Governor Lever
17	29916	1	Governor Lever Clamp
18	651028	1	Screw, T-15, 8-32 x 7/16"
19	34663	1	Speed Control Spring
20	35319	1	Oil Seal
25	37853	1	Blower Housing Baffle
26	650561	2	Screw, 1/4-20 x 19/32"
28	30322	1	Lock Nut, 8-32
30	35571A	1	Crankshaft
35	29826	1	Screw, 10-32 x 3/4"
36	29918	1	Lock Washer
37	29216	1	Lock Nut, 10-32
38	29642	1	Retaining Ring
40	40011	1	Piston, Pin & Ring Set (Std.)
40	40012	1	Piston, Pin & Ring Set (.010" OS)
41	40009	1	Piston & Pin Ass'y. (Std.) (Incl. 43)
41	40010	1	Piston & Pin Ass'y. (.010" OS) (Incl. 43)
42	40013	1	Ring Set (Std.)
42	40014	1	Ring Set (.010" OS)
43	27888	2	Piston Pin Retaining Ring
45	36897	1	Connecting Rod Ass'y. (Incl. 47 & 49)
47	651033	2	Connecting Rod Bolt
48	34034	2	Valve Lifter
49	36896	1	Oil Dipper
50	35375	1	Camshaft (MCR)
60	33273A	1	Blower Housing Extension
65	650128	1	Screw, 10-24 x 1/2"
69	37342	1	* Cylinder Cover Gasket
70	35376A	1	Cylinder Cover (Incl. 71,75,80-84)
71	35377	1	Crankshaft Bushing
72	27642	1	Oil Drain Plug
75	35319	1	Oil Seal
80	37587	1	Governor Shaft
81	651080	1	Washer
82	37588	1	Governor Gear Ass'y. (Incl. 81)
83	30588A	1	Governor Spool
84	29193	1	Retaining Ring
86	650833	7	Screw, 1/4-20 x 1-3/16"
87	650832	1	Screw, 1/4-20 x 1-11/16"
89	32589	1	Flywheel Key
90	611093	1	Flywheel (W/Ring Gear)
92	650880	1	Lock Washer
93	650881	1	Flywheel Nut
100	35135A	1	Solid State Ignition
101	610118	1	Spark Plug Cover
102	651024	2	Solid State Mounting Stud
103	651007	2	Screw, T-15, 10-24 x 15/16"
110	35187	1	Ground Wire
110B	37047	1	Ground Wire
119	36448	1	* Cylinder Head Gasket
120	36449	1	Cylinder Head

Ref #	Part Number	Qty	Description
125	27878A	1	Exhaust Valve (Std.) (Incl. 151)
125	27880A	1	Exhaust Valve (1/32" OS) (Incl.151)
126	34035	1	Intake Valve (Std.) (Incl. 151)
127	650691	2	Washer
130B	651055	2	Screw, 5/16-18 x 5/8"
130	6021A	7	Screw, 5/16-18 x 1-1/2"
130A	650727	2	Screw, 5/16-18 x 1-25/32"
135	35395	1	Resistor Spark Plug (RJ19LM)
139	33369	1	Governor Gear Bracket
140	650836	2	Screw, 10-24 x 1/2"
149	27882	1	Valve Spring Cap
149A	35862	1	Valve Spring Cap
150	27881	2	Valve Spring
151	32581	2	Valve Spring Keeper
169	27896A	2	* Valve Cover Gasket
170	28423	1	Breather Body
171	28424	1	Breather Element
172	28425	1	Valve Cover
173	35350	1	Breather Tube
174	650128	2	Screw, 10-24 x 1/2"
178	29752	2	Nut & Lock Washer, 1/4-28
182	30088A	2	Screw, 1/4-28 x 1"
183	34587A	1	Choke Bracket
184	33263	1	* Carburetor To Intake Pipe Gasket
185	33877	1	Intake Pipe
186B	36652	1	Choke Spring
186	34667	1	Governor Link
200	34677	1	Control Bracket (Incl. 19, 203, 204 & 206)
203	31342	1	Compression Spring
204	651029	1	Screw, T-10, 5-40 x 7/16"
206	610973	1	Terminal
207	33878	1	Throttle Link
209	650821	2	Screw, 10-32 x 1/2"
215	35440	1	Choke Knob
219	34586	1	Choke Rod
220	35438	1	Control Knob
222	28820	2	Screw, 10-32 x 1/2"
223	650378	2	Screw, T-30, 5/16-18 x 1-3/32"
224	27915A	1	* Intake Pipe Gasket
260	35447A	1	Blower Housing
261	650788	2	Screw, 5/16-18 x 3/4"
262	651084	2	Screw, 5/16-18 x 9/16"
264A	650802	1	Screw, 1/2-20 x 5/8"
265	33272D	1	Cylinder Head Cover (Black)
275	35056	1	Muffler
276	31588	1	Locking Plate
277	651002	2	Screw, 5/16-18 x 4-3/16"
285	35985C	1	Starter Cup
287	29752	4	Nut & Lock Washer, 1/4-28
290	30705	1	Fuel Line
291	29774	1	Fuel Line
292	26460	4	Fuel Line Clamp
295	35857	1	Fuel Shut-Off Valve (Incl. 292)
298	650665	2	Screw, 1/4-15 x 7/8"
300	34156A	1	Fuel Tank (Incl. 292 & 301)
301	37844	1	Fuel Cap
305	35554	1	Oil Fill Tube
307	35499	1	"O" Ring

Ref #	Part Number	Qty	Description
308	35540	1	Fill Tube Clip
310	36205	1	Dipstick
314	650873	1	Screw, 1/4-20 x 3/4"
315	611111	1	Alternator Coil (18 Watt) (Incl. 323)
323	611118	2	Terminal
325	29443	1	Wire Clip
328	35062	2	Ignition Key
329	610973	1	Terminal
335	36547	1	Carburetor Cover
336	650765	1	Screw, 10-32 x 1/2"
338	28942	2	Screw, 10-32 x 3/8"
340	34154	1	Fuel Tank Bracket
341	34155	1	Fuel Tank Bracket
342	650561	1	Screw, 1/4-20 x 19/32"
343A	651060	1	Screw, 10-32 x 23/64"
343	35079A	1	Key Switch Bracket
350	570682A	1	Primer Ass'y.
351	32180C	1	Primer Line
355	590574	1	Starter Handle
361A	650819	2	Screw, 6-32 x 2-1/2"
361	650990	2	Screw, T-30, 1/4-20 x 15/32"
364	37659	1	Carburetor Cover Bracket
365	650767	2	Screw, 8-32 x 27/64"
370K	36695	1	Starter Decal
370I	37119	1	Warning Decal
370G	36534	1	Caution Decal
370C	36501	1	Primer Decal
370H	35077	1	Choke Decal
380	640052	1	Carburetor (Incl. 184)
390	590749	1	Rewind Starter (NOTE: This engine could have been built with 590733 starter.)
400	36450C	1	* Gasket Set (Incl. items marked PK in notes)
420	730226A	1	SAE 30, 4-Cycle Engine Oil (Quart)

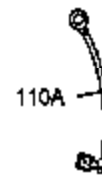
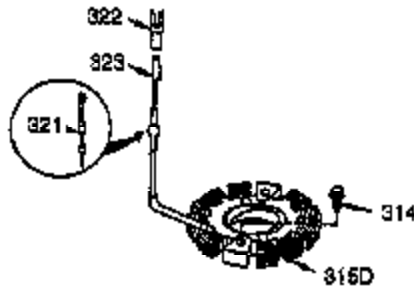
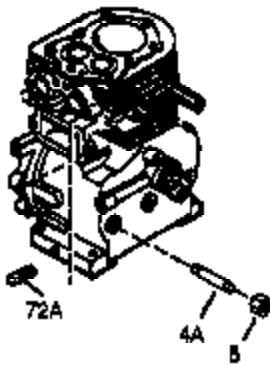
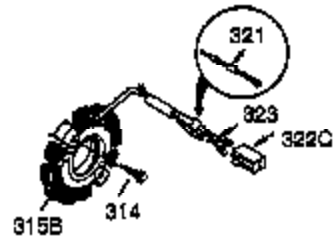
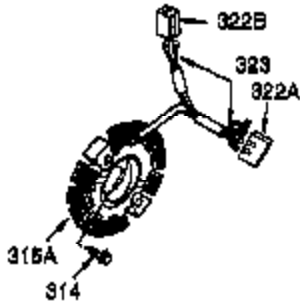
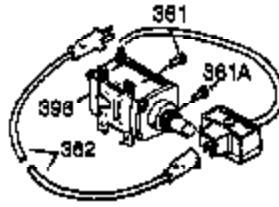
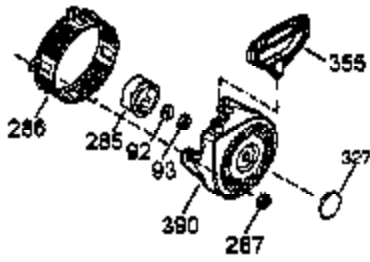

Ref #	Part Number	Qty	Description
92	650880	1	Lock Washer
93	650881	1	Flywheel Nut
285	35985C	1	Starter Cup
287	29752	4	Nut & Lock Washer, 1/4-28
314	650873	1	Screw, 1/4-20 x 3/4"
323	611118	2	Terminal
355	590574	1	Starter Handle
361A	650819	2	Screw, 6-32 x 2-1/2"
361	650990	2	Screw, T-30, 1/4-20 x 15/32"
390	590749	1	Rewind Starter (NOTE: This engine could have been built with 590733 starter.)
396	33329D	1	Electric Starter Motor (120 Volt)