

ILLUSTRATION SHOWS TYPICAL PARTS ONLY. ORDER BY PART NUMBER. PARTS NOT LISTED ARE SUPPLIED BY OEM.

VIEW 1 of 3



Ref #	Part Number	Qty	Description
1	33707A		Cylinder (Incl. 2, 4 & 33) (3-1/2" Bo re)
2	31927		Pipe Plug, 3/8-18 sq. head (Use as re quired)
2	28483		Pipe Plug (3/8-18 hex countersunk) (A s req.)
2			Pipe Plug (3/4-14 sq.hd.)(As req.)(Bu y local)
2	9556		Pipe Plug (1/8-27 sq. hd.) (Use as re quired)
2	28534		Pipe Plug(1/8-27 hex c/sunk headless) (As req)
4	27652		Pin, Dowel
5	33798C		Crankshaft (Incl. 6 thru 9, 140 & 141) NOTE: When using this crankshaft to repair older units equippedwith straight cut cam and governor gears,it will be necessary to order 34751 helical governor gear assembly and 34752 helical camshaft in order to the complete the repair.
6	29783		Pin, Crankshaft gear
7	34692		Gear Crankshaft (Helical)
8	31932		Bearing, Tapered roller
9	31928		Cup, Bearing
11	34511		Piston, Pin & Ring Set (Std.) (3-1/2" Bore)
11	34512		Piston, Pin & Ring Set (.010" OS)
11	34513		Piston, Pin & Ring Set (.020" OS)
11A	32238B		Piston & Pin Ass'y. (Std.)(3-1/2")(In cl.12)
11A	32239B		Piston & Pin Ass'y. (.010" OS) (Incl. 12)
11A	32240B		Piston & Pin Ass'y. (.020 " OS) (Incl . 12)
12	31919		Ring, Piston pin retaining
13	32241		Ring Set (Std.) (3-1/2" Bore)
13	32242		Ring Set (.010" OS)
13	32243		Ring Set (.020" OS)
14	33093A		Connecting Rod Assy.(Std.)(Incl.15, 1 6 & 17)
14	34383		Connecting Rod Assy.(.010" US)(Incl.1 5,16,17)
14	34384		Connecting Rod Assy.(.020" US)(Incl.1 5,16.17)
15	32077		Bolt, Connecting rod
16	26073		Washer, Connecting rod
17	28264		Nut Assy.
18	34752		Camshaft (MCR) (Helical)
19	33472		Lifter, Valve
20	33471		Rod, Push
21	33505		Intake Valve (Std.)
21	33645		Intake Valve (1/32" OS)
22	33506		Exhaust Valve (Std.)
22	33646		Exhaust Valve (1/32" OS)
23	33507		Spring, Valve
24	33508		Retainer & Cap Set, Keeper valve
25A	34410		* "O" Ring (Exhaust only) (Also Incl. i n 251)
25	33509		* "O" Ring (Intake only) (Also Incl. in 251)
26	33510		Cap, Valve
27	34751		Governor Gear Ass'y. (Helical)
28	650745		Washer, Flat
29	35479		Washer, Flat (Use with 35322 spool)
29	30590A		Washer, Flat
30	31948		Spool, Governor
31	31956B		* Gasket, Cylinder cover
32	34649		Cover Assy., Cylinder (Incl. 2, 33 & 134)
33	31950		* Seal, Oil
34	650451		Screw, 1/4-20 x 1"
35	650492		Screw, 1/4-20 x 2-1/4"
36	32425		Rod Assy., Governor
37	32426		Spacer, Governor rod
38	29193		Ring, Retaining

Ref #	Part Number	Qty	Description
39	650736		Screw, 10-16 x 3/8"
40	33495		Cover, Cylinder head
41	34225A		* Gasket, Cylinder head
42	34753		Head, Cylinder
45	33657		Spark Plug (L-82C)
46A	650691		Washer, Flat
46	650690		Washer, Belleville
47	650692		Screw, 5/16-18 x 1-3/4"
47A	650746		Screw, 5/16-18 x 1-3/8"
48	730218		Valve Guide Kit (Incl. 49)
49	792035		Ring, Retaining
50	33515A		* Gasket, Intake pipe
51	33475		Pipe, Intake
52	650378		Screw, Torx T-30, 5/16-18 x 1-1/8"
53	792028		Screw, 5/16-18 x 7/8"
54	33476A		* Gasket, Carburetor
55	33477A		Baffle, Air cleaner
56	792075		Nut, Lock 5/16-24 (Used in early production)
57	33478		Link, Governor lever-to-throttle lever
58	31963		Lever, Governor
59	31964		Clamp, Governor lever
60	650518		Lockwasher, No. 10 E.T.
61	30312		Screw, 10-32 x 1/2"
62	650544		Screw, Torx T-25, 10-24 x 7/8"
63	7975		Nut, 10-24
64	31965		Plate, Governor spring
65	31984A		Lever Assy., Control
66	28558		Washer, Wave
67	31966		Bushing, Governor lever
68	650597		Screw, 10-24 x 5/8"
69	31967		Spring, Governor
70	650591		Screw, 10-24 x 2"
71	33099		Spring
72	32599		"O" Ring (Incl. in 251)
73	650666		Washer, Lock
74	32579		Baffle, Blower housing
75	650561		Screw, 1/4-20 x 5/8"
76	650592		Key, Flywheel
77	610909		Flywheel
77A	730201		Trigger Pin Kit (Use as required)
78	650594		Nut, Flywheel
79	610906		Solid State Magneto (Incl. 158 thru 1 61)
80	650661		Screw, 1/4-20 x 3/4"
81	33479		Extension, Blower housing
82	30063		Screw, 1/4-20 x 1/2"
83	650751		Screw, 1/4-20 x 7/16"
84	33775A		Blower Hsg.(Incl.218A,219)(For elec.s tarter)
85	8274		Washer, Lock
85A	8274		Washer, Lock
86	650595		Screw, 5/16-24 x 3/8"
86A	650595		Screw, 5/16-24 x 3/8"
87	650752		Screw, 1/4-20 x 7/16"
88	35475		Tube, Push rod
89	33481		* "O" Ring (Also Incl. in 251)
90	34754		Housing, Rocker arm
94	33484		* "O" Ring (Also Incl. in 251)
95	650168		Washer, Flat
96	32610A		Screw, 1/4-20 x 29/32"

Ref #	Part Number	Qty	Description
97	33485		Arm, Rocker
98	33486		Ring, Retaining
99	650755		Screw, 1/4-20 x 3/4"
100	650864		Nut, Hex, 1/4-20
101	650756		Stud, Rocker arm
102	33487		* "O" Ring (Also Incl. in 251)
103	33488		Cover, Rocker arm
104	31958A		* Gasket, Breather (Also Incl. in 251)
105	33489		Body Assy., Breather
106	33490		Tube, Breather
107	30102		* Screw, 10-32 x 5/8" (Also Incl. in 25 1)
108	650738		Screw, 1/4-20 x 5/8"
111	35471		* Gasket, Air cleaner
112	35472		Bracket, Air cleaner
114	650399		Screw, 10-32 x 5/8"
115	32008		Element, Air cleaner
116A	32810		Cover, Air cleaner
117	650513		Nut, Wing
119	32426		Spacer, Screen
120	33776		Screen, Pulley
122	650670		Screw, 1/4-20 x 3/4"
123	27070		Washer, Lock
123	650675		Washer, Flat
137	650744		Screw, 10-24 x 7/8"
138	34650		Tube extension, Oil fill
146	32577		Cover, Cylinder NOTE: Determine the gap between the cover and the machined surface on the cylinder, which can be from .001" up to .007", in which case no shim gaskets will be required. Use of gaskets must be limited to a combined total of .010" thick. Steel spacers must be used as required to eli
147	792028		Screw, 5/16-18 x 7/8"
155	31971		* Gasket, Shim (.004/.005 thick) NOTE: Determine the gap between the cover and the machined surface on the cylinder, which can be from .001" up to .007", in which case no shim gaskets will be required. Use of gaskets must be limited to a combined total of .010" thick. Steel spacers must be used a
156	31972		* Gasket, Shim (.005/.007 thick) NOTE: Determine the gap between the cover and the machined surface on the cylinder, which can be from .001" up to .007", in which case no shim gaskets will be required. Use of gaskets must be limited to a combined total of .010" thick. Steel spacers must be used a
157	32031		* Spacer, Steel (.010 thick) NOTE: Determine the gap between the cover and the machined surface on the cylinder, which can be from .001" up to .007", in which case no shim gaskets will be required. Use of gaskets must be limited to a combined total of .010" thick. Steel spacers must be used as re
158	610118		Cover, Spark plug
159	610750		Grommet, Lead wire
160	610408		Nut, 8-32
161	610908		Terminal, Female
169	27793		Clip, Conduit
169A	27793		Clip, Conduit
170A	28942		Screw, 10-32 x 3/8"

Ref #	Part Number	Qty	Description
170	28942		Screw, 10-32 x 3/8"
189	33764		Dipstick (Incl. 190)
190	29985		"O" Ring
191	33468		Tube Assy., Oil filler
192	29673		* Gasket, Oil filler tube
244B	31752		Decal, Air cleaner
244A	34768		Decal, Name
244	34346		Decal, Instruction
246	631687		Valve, Seat & Spring Assy.
247	632197		Carburetor (Incl. 54 & 246) (Refer to Division 5, Section A, page 160 for breakdown)
250	33516G		* Gasket Set (Incl. items marked *)
251	35075		"O" Ring Kit (Incl. Nos. items marked +)

ILLUSTRATION SHOWS TYPICAL PARTS ONLY. ORDER BY PART NUMBER. PARTS NOT LISTED ARE SUPPLIED BY OEM.

VIEW 2 of 3



Ref #	Part Number	Qty	Description
	39 650736		Screw, 10-16 x 3/8"
	82 30063		Screw, 1/4-20 x 1/2"
	126A 35731		Muffler (Incl. 126B)
	132 34651		Weight Assy., Counterbalance
	133 33501		Bearing, Needle
	134 33502		Shaft, Counterbalance
	135 33503		Washer, Thrust
	136 792017		Ring, Retaining
	140 33499		Spacer
	141 33963		Gear, Counterbalance weight (Helical teeth)
	141		Gear, Counterbalance weight (Straight teeth) (For replacement see Ref. 132. Order correct kit for your enginemodel number.)
	148 610902		Alt.Coil Ass'y. (Incl.162,163,163A) (20 amp)
	149 650521		Screw, 10-32 x 1-1/8"
	151A 610996		Regulator (20 Amp) (Incl. 212 thru 21 8)
	153 792028		Screw, 5/16-18 x 7/8"(Use w/32817 str .motor)
	153 650781		Screw,5/16-18 x 11/16"(Use w/33835 st r.motor)
	162A 610903		Connector, Flat
	163A 610905		Terminal
	163 610904		Terminal
	209 730178		Ech.Adapter Kit (Incl.210 & 211)(As r equired)
	210 34102B		Gasket, Exhaust (Use as required)
	211 30196		Screw, 5/16-18 x 3/4" (Use as require d)
	212 610990		Connector, Male
	213 610921		Connector
	214 610922		Terminal
	215 610989		Terminal
	216 610992		Terminal, Female
	217 610991		Terminal, Female
	218 30063		Screw, 1/4-20 x 1/2"
	238 730212		Adapter Plate Kit (Optional) NOTE: If you are having mounting problems in using a HH100 thru OH180 in place of a large frame competitivebrand, we would like to call your attention to 730212 adapter plate kit. The kit converts the bottom mounting system found on HH100 thru OH180 to a top mounting sys
	249 33835		Electric Starter Motor (12-Volt) (Refer to Division 5, Section D for breakdown)

ILLUSTRATION SHOWS TYPICAL PARTS ONLY. ORDER BY PART NUMBER. PARTS NOT LISTED ARE SUPPLIED BY OEM.

VIEW 3 of 3

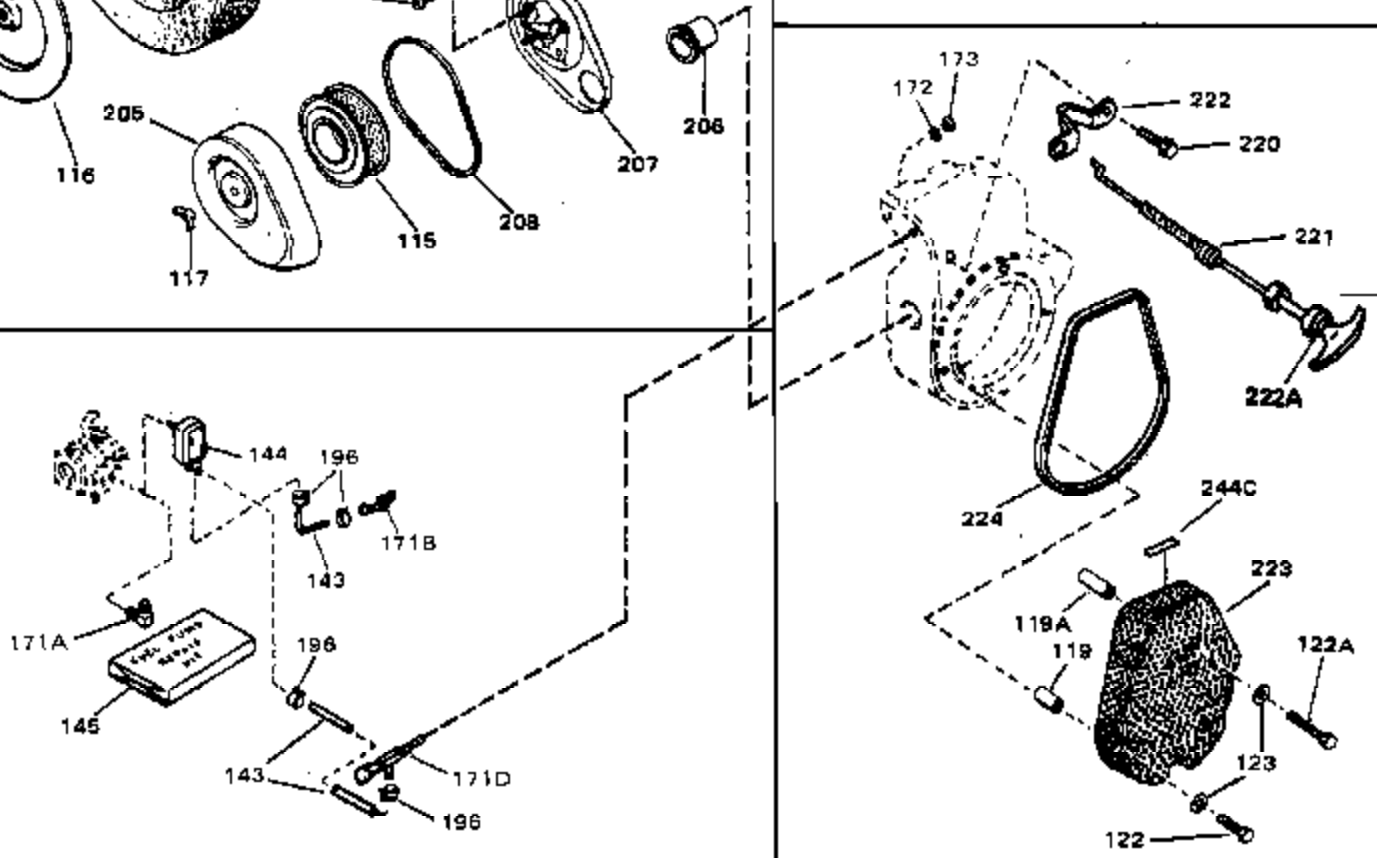
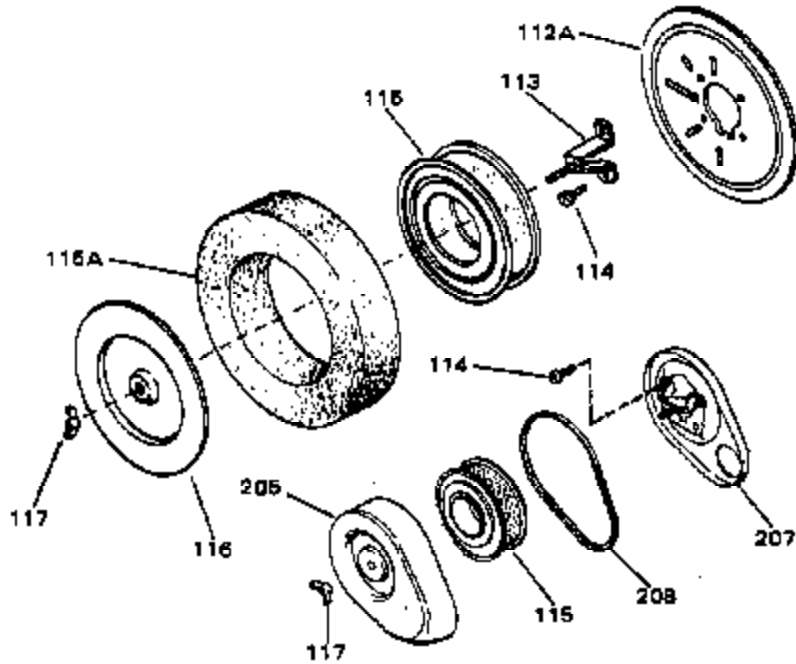

Ref #	Part Number	Qty	Description
114	650399		Screw, 10-32 x 5/8"
115	32008		Element, Air cleaner
117	650513		Nut, Wing
119	32426		Spacer, Screen
122	650670		Screw, 1/4-20 x 3/4"
123	27070		Washer, Lock
123	650675		Washer, Flat
143	29774		Fuel Line (Braided 8.25")(21 cm)(As r equired)
143	30705		Fuel Line (Braided 16")(41 cm)(As req uired)
143	30962		Fuel Line (Braided 32")(81 cm)(As req uired)
171A	28566		Fitting, Fuel line
178	410144B		Fuel Cap (White Plastic)(Std)(As requ ired)
178	34210		Fuel Cap (Red Plastic) (Spurt resistant, High profile) (Use as required)
196	26460		Clamp, Fuel line (Use as required)
245	730134		Rewind Starter Kit (Incl.120A, 121, 122, 187, 188 & 248) (Use as required)