

Ref #	Part Number	Qty	Description
1	33707A		Cylinder (Incl. 2, 4 & 33) (3-1/2" Bore)
2	31927		Pipe Plug, 3/8-18 sq. head (Use as required)
2	28483		Pipe Plug (3/8-18 hex countersunk) (As req.)
2			Pipe Plug (3/4-14 sq.hd.)(As req.)(Buy local)
2	9556		Pipe Plug (1/8-27 sq. hd.) (Use as required)
2	28534		Pipe Plug(1/8-27 hex c/sunk headless) (As req)
4	27652		Pin, Dowel
5	33423B		Crankshaft (Incl. 6 thru 9) NOTE: When using this crankshaft to repair older units equipped with straight cut cam and governor gears, it will be necessary to order 34751 helical governor gear assembly and 34752 helical camshaft in order to complete the repair.
6	29783		Pin, Crankshaft gear
7	34692		Gear Crankshaft (Helical)
8	31932		Bearing, Tapered roller
9	31928		Cup, Bearing
10A	34223		Bearing & Seal Assy., Needle
10	34222		Bearing, Needle
11	34511		Piston, Pin & Ring Set (Std.) (3-1/2" Bore)
11	34512		Piston, Pin & Ring Set (.010" OS)
11	34513		Piston, Pin & Ring Set (.020" OS)
11A	32238B		Piston & Pin Ass'y. (Std.)(3-1/2")(Incl.12)
11A	32239B		Piston & Pin Ass'y. (.010" OS) (Incl. 12)
11A	32240B		Piston & Pin Ass'y. (.020" OS) (Incl. 12)
12	31919		Ring, Piston pin retaining
13	32241		Ring Set (Std.) (3-1/2" Bore)
13	32242		Ring Set (.010" OS)
13	32243		Ring Set (.020" OS)
14	33093A		Connecting Rod Assy.(Std.)(Incl.15, 16 & 17)
14	34383		Connecting Rod Assy.(.010" US)(Incl.15,16,17)
14	34384		Connecting Rod Assy.(.020" US)(Incl.15,16,17)
15	32077		Bolt, Connecting rod
16	26073		Washer, Connecting rod
17	28264		Nut Assy.
18	34752		Camshaft (MCR) (Helical)
19	33472		Lifter, Valve
20	33471		Rod, Push
21	33505		Intake Valve (Std.)
21	33645		Intake Valve (1/32" OS)
22	33506		Exhaust Valve (Std.)
22	33646		Exhaust Valve (1/32" OS)
23	33507		Spring, Valve
24	33508		Retainer & Cap Set, Keeper valve
25A	34410		* "O" Ring (Exhaust only) (Also Incl. in 251)
25	33509		* "O" Ring (Intake only) (Also Incl. in 251)
26	33510		Cap, Valve
27	34751		Governor Gear Ass'y. (Helical)
28	650745		Washer, Flat
29	35479		Washer, Flat (Use with 35322 spool)
30	35322		Spool, Governor
31	31956B		* Gasket, Cylinder cover
32	34095		Cylinder Cover Ass'y. (Incl. 2, 10, 10A, 33, 36, 37, 38, 93, 194 & 195)
33	31950		* Seal, Oil
34	650451		Screw, 1/4-20 x 1"
35	650588		Screw, 1/4-20 x 2"
36	32425		Rod Assy., Governor

Ref #	Part Number	Qty	Description
37	32426		Spacer, Governor rod
38	29193		Ring, Retaining
39	650736		Screw, 10-16 x 3/8"
40	33495		Cover, Cylinder head
41	34225A		* Gasket, Cylinder head
42	34753		Head, Cylinder
43	35049		Guard, Flywheel
45	35552		Spark Plug (RL-82C)
46A	650691		Washer, Flat
46	650690		Washer, Belleville
47	650692		Screw, 5/16-18 x 1-3/4"
47A	650746		Screw, 5/16-18 x 1-3/8"
48	730218		Valve Guide Kit (Incl. 49)
49	792035		Ring, Retaining
50	33515A		* Gasket, Intake pipe
51	33475		Pipe, Intake
52	650378		Screw, Torx T-30, 5/16-18 x 1-1/8"
53	792028		Screw, 5/16-18 x 7/8"
54	33476A		* Gasket, Carburetor
55	33477A		Baffle, Air cleaner
56	792075		Nut, Lock 5/16-24 (Used in early production)
57	33478		Link, Governor lever-to-throttle lever
57A	33983		Link, Governor lever-to-throttle lever
58	31963		Lever, Governor
59	31964		Clamp, Governor lever
60	650518		Lockwasher, No. 10 E.T.
61	30312		Screw, 10-32 x 1/2"
62	650544		Screw, Torx T-25, 10-24 x 7/8"
63	7975		Nut, 10-24
64	31965		Plate, Governor spring
65	34456		Lever Assy., Control
67	31966		Bushing, Governor lever
68	650597		Screw, 10-24 x 5/8"
69	34458		Spring, Governor
69A	34458		Spring, Governor
70	650591		Screw, 10-24 x 2"
71	33099		Spring
72	32599		"O" Ring (Incl. in 251)
73	650666		Washer, Lock
74	32579		Baffle, Blower housing
75	650561		Screw, 1/4-20 x 5/8"
76	650592		Key, Flywheel
77	610909		Flywheel
77A	730201		Trigger Pin Kit (Use as required)
78	650594		Nut, Flywheel
79	610906		Solid State Magneto (Incl. 158 thru 1 61)
80	650661		Screw, 1/4-20 x 3/4"
81	33479		Extension, Blower housing
83	650751		Screw, 1/4-20 x 7/16"
84	34314B		Blower Hsg.(Incl.218A,219)(For elec.s tarter)
85A	8274		Washer, Lock
85	8274		Washer, Lock
86	650595		Screw, 5/16-24 x 3/8"
86A	650595		Screw, 5/16-24 x 3/8"
87	650752		Screw, 1/4-20 x 7/16"
88	35475		Tube, Push rod
89	33481		* "O" Ring (Also Incl. in 251)
90	34754		Housing, Rocker arm

Ref #	Part Number	Qty	Description
93	8345		Washer, Flat
94	33484		* "O" Ring (Also Incl. in 251)
95	650168		Washer, Flat
96	32610A		Screw, 1/4-20 x 29/32"
97	33485		Arm, Rocker
98	33486		Ring, Retaining
99	650755		Screw, 1/4-20 x 3/4"
100	650864		Nut, Hex, 1/4-20
101	650756		Stud, Rocker arm
102	33487		* "O" Ring (Also Incl. in 251)
103	33488		Cover, Rocker arm
104	31958A		* Gasket, Breather (Also Incl. in 251)
105	33489		Body Assy., Breather
106	33490		Tube, Breather
107	30102		* Screw, 10-32 x 5/8" (Also Incl. in 25 1)
108	650738		Screw, 1/4-20 x 5/8"
111	35471		* Gasket, Air cleaner
112	35472		Bracket, Air cleaner
114	650399		Screw, 10-32 x 5/8"
115	32008		Element, Air cleaner
116A	32810		Cover, Air cleaner
117	650513		Nut, Wing
119	31992		Spacer, Screen
120	33776		Screen, Pulley
122	650680		Screw, 1/4-20 x 1-1/2"
123	27070		Washer, Lock
128	33450		Nut, Lock, 10-32
129A	30845A		Bolt, Governor spring adj.
129	650488		Screw, 1/4-20 x 1-1/4"
130	34457		Bracket, Control
131	650168		Washer, Flat
146	32577		Cover, Cylinder NOTE: Determine the gap between the cover and the machined surface on the cylinder, which can be from .001" up to .007", in which case no shim gaskets will be required. Use of gaskets must be limited to a combined total of .010" thick. Steel spacers must be used as required to eli
147	792028		Screw, 5/16-18 x 7/8"
155	31971		* Gasket, Shim (.004/.005 thick) NOTE: Determine the gap between the cover and the machined surface on the cylinder, which can be from .001" up to .007", in which case no shim gaskets will be required. Use of gaskets must be limited to a combined total of .010" thick. Steel spacers must be used a
156	31972		* Gasket, Shim (.005/.007 thick) NOTE: Determine the gap between the cover and the machined surface on the cylinder, which can be from .001" up to .007", in which case no shim gaskets will be required. Use of gaskets must be limited to a combined total of .010" thick. Steel spacers must be used a
157	32031		* Spacer, Steel (.010 thick) NOTE: Determine the gap between the cover and the machined surface on the cylinder, which can be from .001" up to .007", in which case no shim gaskets will be required. Use of gaskets must be limited to a combined total of .010" thick. Steel spacers must be used as re
158	610118		Cover, Spark plug

Ref #	Part Number	Qty	Description
159	610750		Grommet, Lead wire
160	610408		Nut, 8-32
161	610908		Terminal, Female
189	33993A		Dipstick (Incl. 190)
190	33590		"O" Ring
191	33992A		Tube, Oil filler
244	34346		Decal, Instruction
244A	35532		Decal, Name
244B	31752		Decal, Air cleaner
246	631687		Valve, Seat & Spring Assy.
247	632456		Carburetor (Incl. 54 & 246) (Refer to Division 5, Section A, page 204 for breakdown)
250	33516G		* Gasket Set (Incl. items marked *)
251	35075		"O" Ring Kit (Incl. Nos. items marked +)

ILLUSTRATION SHOWS TYPICAL PARTS ONLY. ORDER BY PART NUMBER. PARTS NOT LISTED ARE SUPPLIED BY OEM.

VIEW 2 of 3

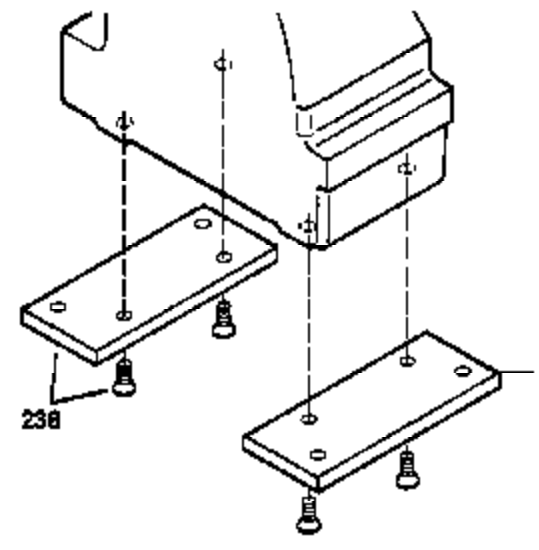

Ref #	Part Number	Qty	Description
39	650736		Screw, 10-16 x 3/8"
126A	35731		Muffler (Incl. 126B)
141			Gear, Counterbalance weight (Straight teeth) (For replacement see Ref. 132. Order correct kit for your enginemodel number.)
148	610902		Alt.Coil Ass'y. (Incl.162,163,163A) (20 amp)
149	650521		Screw, 10-32 x 1-1/8"
151A	610996		Regulator (20 Amp) (Incl. 212 thru 21 8)
153	792028		Screw, 5/16-18 x 7/8"(Use w/32817 str .motor)
153	650781		Screw,5/16-18 x 11/16"(Use w/33835 st r.motor)
162A	610903		Connector, Flat
163A	610905		Terminal
163	610904		Terminal
209	730178		Ech.Adapter Kit (Incl.210 & 211)(As r equired)
210	34102B		Gasket, Exhaust (Use as required)
211	30196		Screw, 5/16-18 x 3/4" (Use as require d)
212	610990		Connector, Male
213	610921		Connector
214	610922		Terminal
215	610989		Terminal
216	610992		Terminal, Female
217	610991		Terminal, Female
218	30063		Screw, 1/4-20 x 1/2"
238	730212		Adapter Plate Kit (Optional) NOTE: If you are having mounting problems in using a HH100 thru0H180 in place of a large frame competitivebrand, we would like to call your attention to 730212 adapter plate kit. The kit converts the bottom mounting system found on HH100 thru 0H180 to a top mounting sys
249	33835		Electric Starter Motor (12-Volt) (Refer to Division 5, Section D for breakdown)

Ref #	Part Number	Qty	Description
114	650399		Screw, 10-32 x 5/8"
115	32008		Element, Air cleaner
117	650513		Nut, Wing
119	31992		Spacer, Screen
122	650680		Screw, 1/4-20 x 1-1/2"
123	27070		Washer, Lock
143	29774		Fuel Line (Braided 8.25")(21 cm)(As required)
143	30705		Fuel Line (Braided 16")(41 cm)(As required)
143	30962		Fuel Line (Braided 32")(81 cm)(As required)
144	33715		Pump, Impulse fuel
145	33010		Repair Kit, Impulse fuel pump
171C	29683		Valve, Fuel strainer & shut-off
171B	32958		Fitting, Fuel pump
177	33979		Fuel Tank (Incl. 178)
178	410144B		Fuel Cap (White Plastic)(Std)(As required)
178	34210		Fuel Cap (Red Plastic) (Spurt resistant, High profile) (Use as required)
180	33980		Strap, Fuel tank
181	33978		Bracket, Fuel tank
182	650787		Washer, Belleville
183	650786		Screw, 1/4-20 x 5/8"
184	650785		Screw, 5/16-18 x 5/8"
185	650488		Screw, 1/4-20 x 1-1/4"
186	650456		Nut, Lock
196	26460		Clamp, Fuel line (Use as required)
245	730134		Rewind Starter Kit (Incl.120A, 121, 122, 187, 188 & 248) (Use as required)