

Ref #	Part Number	Qty	Description
1	37120B	1	Cylinder (Incl. 2, 20, 72 & 72A)
2	26727	2	Dowel Pin
14	651052	1	Washer
15	37108	1	Governor Rod
16	37110	1	Governor Lever
23	36732	1	Ball Bearing
27	36733	1	Bearing Retainer
30	36845	1	Crankshaft
35	651053	1	Screw, T-25, 10-32 x 63/64"
37	29216	1	Lock Nut, 10-32
38	37109	1	Retaining Ring
40	40004	1	Piston, Pin & Ring Set (Std.)
40	40005	1	Piston, Pin & Ring Set (.010" OS)
41	36070	1	Piston & Pin Ass'y (Std.) (Incl. 43)
41	36071	1	Piston & Pin Ass'y (.010" OS) (Incl. 43)
42	40006	1	Ring Set (Std.)
42	40007	1	Ring Set (.010" OS)
43	20381	2	Piston Pin Retaining Ring
45	32875A	1	Connecting Rod Ass'y (Incl. 46 & 49)
46	32610A	2	Connecting Rod Bolt
48	35616	2	Valve Lifter
49	36611	1	Oil Dipper
50	37040	1	Camshaft (Incl. 253 & 254)
64	651015	1	Screw, 1/4-20 x 1-1/8"
69	36624	1	* Cylinder Cover Gasket
70	36731	1	Cylinder Cover (Incl. 75 thru 83 & 31 1)
72A	28582	1	Oil Drain Plug
72	27642	2	Oil Drain Plug
74A	28537	2	Washer
74	30200	2	Screw, 10-24 x 9/16"
75	36742	1	Oil Seal
80	30574A	1	Governor Shaft
81	30590A	1	Washer
82	30591	1	Governor Gear Ass'y (Incl. 81)
83	36057	1	Governor Spool
86	650488	8	Screw, 1/4-20 x 1-1/4"
89	610961	1	Flywheel Key
119	36719	1	* Cylinder Head Gasket
120	37474	1	Cylinder Head
125	36471	1	Exhaust Valve (Std.) (Incl. 151)
125	36472	1	Exhaust Valve (1/32" OS) (Incl. 151)
126	37711	1	Intake Valve (Std.) (Incl. 151)
130A	650999	1	Screw, 5/16-18 x 2-41/64"
130	650912	4	Screw, 5/16-18 x 1-1/2"
135	34645	1	Resistor Spark Plug (RN4C)
150	37039	2	Valve Spring
151A	40016A	1	Intake Valve Seal
151	31673	2	Valve Spring Cap
153	36649	1	Push Rod Guide
154	650913	2	Rocker Arm Stud
155	35624A	2	Rocker Arm
157	650914	2	Nut, 1/4-28
158	36629	2	Push Rod
159	35626	1	* Rocker Arm Cover Gasket
160	36630A	1	Rocker Arm Cover
161A	651012	2	Stud
161	651008	2	Screw, 1/4-20 x 31/64"
173	36675A	1	Breather Tube

Ref #	Part Number	Qty	Description
178	650852	2	Nut, 1/4-20
182	650451	2	Screw, 1/4-20 x 1"
184	26756	1	* Carburetor To Intake Pipe Gasket
185	36631	1	Intake Pipe
207	36632	1	Throttle Link
223	650451	2	Screw, 1/4-20 x 1"
224	36581	1	* Intake Pipe Gasket
238	28820	2	Screw, 10-32 x 1/2"
239	27272A	1	* Air Cleaner Gasket
240	36633A	1	Air Cleaner Body (Incl. 239)
245A	36634	1	Air Cleaner Filter
245	36046	1	Air Cleaner Filter
250A	37074	1	Air Cleaner Baffle
250	37073	1	Air Cleaner Cover
251	650886	1	Wing Nut
252	650821	1	Screw, 10-32 x 1/2"
253	36701	1	Compression Release Weight
254	36702	1	Compression Release Spring
275	37595	1	Muffler
277	650988	2	Screw, 1/4-20 x 2-9/32"
278	36674	1	Spacer
279	650852	2	Nut & Lock Washer
280	36893	1	Heat Shield
305	36877	1	Oil Fill Tube
307	35499	1	"O" Ring
308	37079	1	Fill Tube Clip
310	36878	1	Dipstick
311	27625	2	Oil Fill Plug (Incl. 312)
312	29673	2	* Oil Fill Plug Gasket
380	640340	1	Carburetor (Incl. 184)
416	36085	1	Spark Arrestor Kit (Incl. 417) (Optional)
417	650760	1	Screw, 8-32 x 3/8"
600	651013	1	Washer

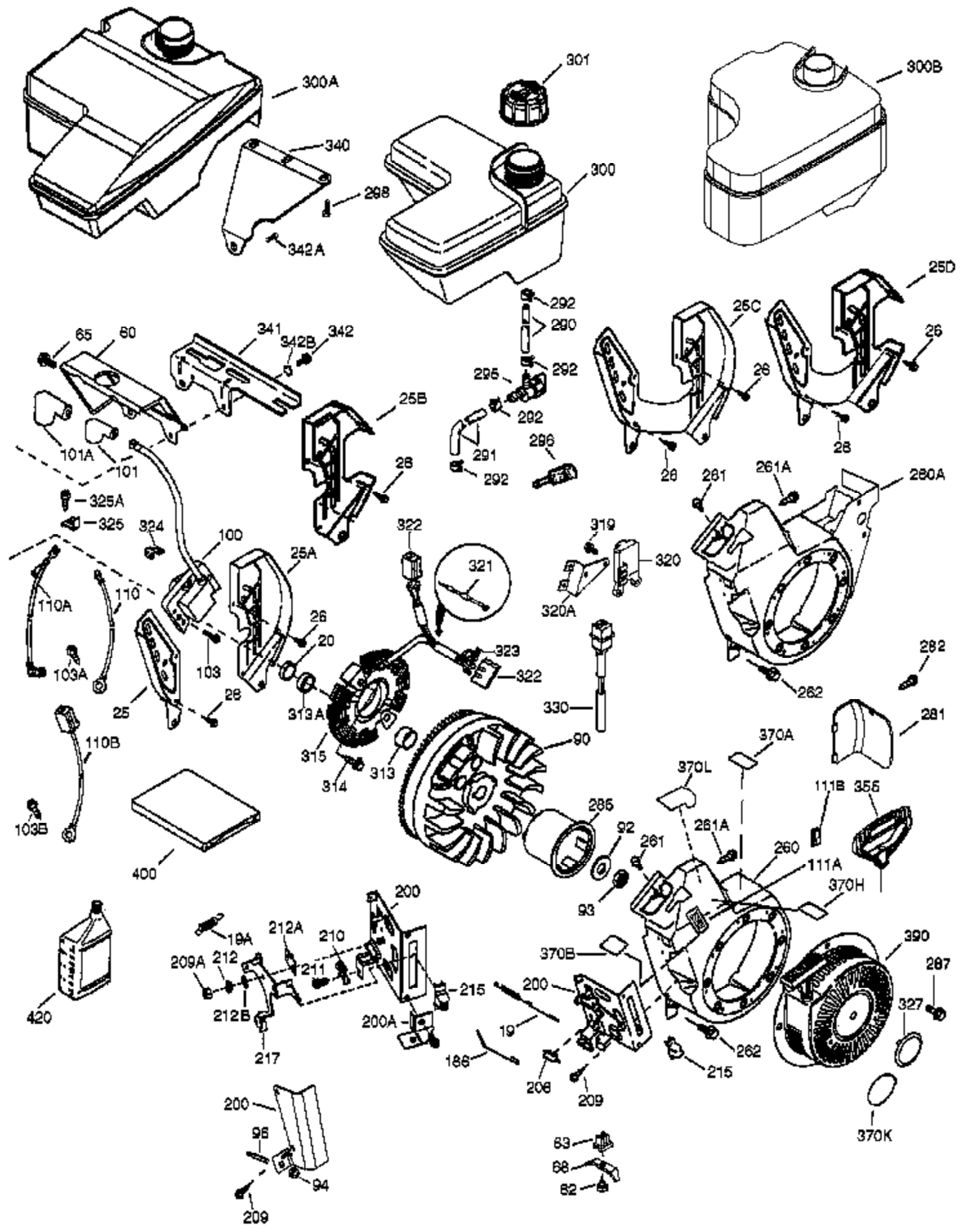

Ref #	Part Number	Qty	Description
19	37111	1	Extension Spring
20	32600	1	Oil Seal
25C	37709	1	Air Baffle (1 pc.)
26	30200	1	Screw, 10-24 x 9/16"
60	36623A	1	Blower Housing Extension
62	650760	1	Screw, 8-32 x 3/8"
63	28545	1	Grommet
65	30200	1	Screw, 10-24 x 9/16"
68	33356	1	Ground Terminal
90	611205	1	Flywheel
92	650815	1	Belleville Washer
93	650816	1	Flywheel Nut
100	34443B	1	Solid State Ignition
101	610118	1	Spark Plug Cover
103	651007	2	Screw, T-15, 10-24 x 15/16"
110	36679A	1	Ground Wire
186	36711	1	Governor Link
200A	36686	1	Boden Wire Bracket
200	36736	1	Control Bracket (Incl. 206 & 209A thr u 217)
206	610973	1	Terminal
209A	651016	1	Nut, 10-32
209	650821	1	Screw, 10-32 x 1/2"
210	27793	1	Conduit Clip
211	28942	1	Screw, 10-32 x 3/8"
212A	36685	1	Bearing Plate
212	30773A	1	Bushing
212B	651017	1	Washer
215	36638	1	Control Knob
217	36684	1	Control Lever Assembly
260	36864	1	Blower Housing
261A	650821	2	Screw, 10-32 x 1/2"
261	651008	1	Screw, 1/4-20 x 31/64"
262	651008	2	Screw, 1/4-20 x 31/64"
285	35985B	1	Starter Cup
287	651008	4	Screw, 1/4-20 x 31/64"
290	30705	1	Fuel Line
292	26460	2	Fuel Line Clamp
300	37048	1	Fuel Tank (Incl. 292 & 301)
301	35355	1	Fuel Cap
313	34080	1	Spacer
341	36644A	1	Fuel Tank Bracket
342B	651086	2	Rubber Washer
342	651085	2	Screw, 1/4-20 x 19/32"
370B	35703	1	Speed Control Decal
370K	36695	1	Starter Decal
370A	36261	1	Lubrication Decal
390	590746	1	Rewind Starter (NOTE: This engine could have been built with 590704 starter.)
400	36720	1	* Gasket Set (Incl. items marked PK in notes)
420	730225	1	SAE 30 4-Cycle Engine Oil (Quart)