

Ref #	Part Number	Qty	Description
1	37083	1	Cylinder (Incl. 2, 20, 72 & 80)
2	27652	2	Dowel Pin
14A	651057	1	Washer
14	28277	1	Washer
14	28277	1	Washer
15	35685	1	Governor Rod (Incl. 14 & 38)
16	35686A	1	Governor Lever (Incl. 212A)
17	29916	1	Governor Lever Clamp
18	651028	1	Screw, T-15, 8-32 x 7/16"
19	35688	1	Extension Spring
20	35319	1	Oil Seal
25	36460	1	Blower Housing Baffle
26	650561	2	Screw, 1/4-20 x 19/32"
28	30322	1	Nut & Lock Washer, 8-32
30	35680A	1	Crankshaft
31	35327	1	Counterbalance Gear
35	29826	1	Screw, 10-32 x 3/4"
36	29918	1	Lock Washer
37	29216	1	Lock Nut, 10-32
38	29642	3	Retaining Ring
40	35776A	1	Piston, Pin & Ring Set (Std.)
40	35777A	1	Piston, Pin & Ring Set (.010" OS)
40	35778A	1	Piston, Pin & Ring Set (.020" OS)
41	35773A	1	Piston & Pin Ass'y (Std.) (Incl. 43)
41	35774A	1	Piston & Pin Ass'y (.010" OS) (Incl. 43)
41	35775A	1	Piston & Pin Ass'y (.020" OS) (Incl. 43)
42	35779	1	Ring Set (Std.)
42	35780	1	Ring Set (.010" OS)
42	35781	1	Ring Set (.020" OS)
43	35772	2	Piston Pin Retaining Ring
45	36898	1	Connecting Rod Ass'y (Incl. 47)
47	651033	2	Connecting Rod Bolt
48	35313	2	Valve Lifter
50	35682A	1	Camshaft (MCR)
51	35315A	1	Counterbalance Weight
60	35316A	1	Blower Housing Extension
65	650128	1	Screw, 10-24 x 1/2"
66	650561	1	Screw, 1/4-20 x 19/32"
69	35683	1	* Cylinder Cover Gasket
70	35684A	1	Cylinder Cover (Incl. 14,15,38,71,75)
71	35377	1	Crankshaft Bushing
72	27642	2	Oil Drain Plug
75	35319	1	Oil Seal
80	35751	1	Governor Shaft
81	35479A	2	Washer
82	35321	1	Governor Gear Ass'y
83	35322	1	Governor Spool
84	29193	1	Retaining Ring
86	650833	7	Screw, 1/4-20 x 1-3/16"
87	650832	1	Screw, 1/4-20 x 1-11/16"
89	32589	1	Flywheel Key
90	611090	1	Flywheel (W/Ring Gear)
92	650880	1	Lock Washer
93	650881	1	Flywheel Nut
100	35135A	1	Solid State Ignition (Incl. 101)
101	610118	1	Spark Plug Cover
102	651024	2	Solid State Mounting Stud
103	651007	2	Screw, T-15, 10-24 x 15/16"

Ref #	Part Number	Qty	Description
119	36932	1	* Cylinder Head Gasket
120	37491	1	Cylinder Head (Incl. 151A & 270)
125	36934	1	Exhaust Valve (Std.)
125	36936	1	Exhaust Valve (1/32" OS)
126	36935	1	Intake Valve (Std.)
126	36937	1	Intake Valve (1/32" OS)
127	650691	6	Washer
128	650690	6	Belleville Washer
130	650697A	6	Screw, 5/16-18 x 2-1/2"
135	34645	1	Spark Plug (RN4C)
150	33507	2	Valve Spring
151A	35862	1	Intake Valve Seal
151	33508	2	Valve Spring Keeper
153	35949	1	Push Rod Guide
154	650945	2	Rocker Arm Stud
155	35950	2	Rocker Arm
157	650947	2	Jam Nut
158	35466	2	Push Rod
159	35952	1	* Rocker Arm Cover Gasket
160	35953A	1	Rocker Arm Housing
161	30063	4	Screw, T-30, 1/4-20 x 1/2"
163	650890	2	Lock Washer
169	27896A	2	* Valve Cover Gasket
170	28423	1	Breather Body
171	28424	1	Breather Element
172	28425	1	Valve Cover
173	35350	1	Breather Tube
174	650128	2	Screw, 10-24 x 1/2"
180	37101	1	Blower Housing Extension
181	30200	2	Lock Nut, 10-32
182	650517	2	Screw, T-30, 1/4-20 x 27/32"
184	33263	1	* Carburetor To Intake Pipe Gasket
185	37085	1	Intake Pipe
186	35691	1	Governor Link
200	35702	1	Control Bracket (Incl. 203 & 204)
202	36482	1	Compression Spring
203	31342	1	Compression Spring
204	651029	1	Screw, T-10, 5-40 x 7/16"
205	651019	1	Screw, T-10, 6-32 x 41/64"
206	610973	1	Terminal
207	35692	1	Throttle Link
209	650821	2	Screw, 10-32 x 1/2"
212A	36288	1	Bushing
212	30773A	1	Bushing
213	650930	1	Screw, 10-32 x 5/8"
215	32410	1	Control Knob
216	35679	1	R.P.M. Adjusting Lever
223	650971	2	Screw, T-30, 5/16-18 x 7/8"
224	33515A	1	* Intake Pipe Gasket
233A	37169	1	"O" Ring
233	37168	1	"O" Ring
260	35716A	1	Blower Housing
262	29747B	2	Screw, T-40, 5/16-24 x 21/32"
264A	30063	1	Screw, T-30, 1/4-20 x 1/2"
265	37086	1	Cylinder Head Cover
266	650876	2	Screw, 5/16-18 x 1-9/32"
269	35762	2	* Exhaust Manifold Gasket
270	35870	1	Exhaust Manifold

Ref #	Part Number	Qty	Description
270A	35829A	1	Exhaust Port Liner
271	35293	1	Locking Plate (Manifold)
275	36542	1	Muffler
276	35348	1	Locking Plate
277	650877	2	Screw, 5/16-18 x 4-1/2"
281	33013	1	Starter Bubble Cover
282	650760	1	Screw, 8-32 x 3/8"
285	35985B	1	Starter Cup
287	29752	4	Nut & Lock Washer, 1/4-28
290	30962	1	Fuel Line
292	26460	4	Fuel Line Clamp
298	650665	2	Screw, 1/4-15 x 3/4"
300	34186A	1	Fuel Tank (Incl. 292 & 301)
301	36246	1	Fuel Cap
305	35574	1	Oil Fill Tube
307	35499	1	"O" Ring
308	35539	1	Fill Tube Clip
310	35700	1	Dipstick
340	35696	1	Fuel Tank Bracket
341	35697	1	Fuel Tank Bracket
342	792028	2	Screw, 5/16-18 x 7/8"
345	35699	1	Heat Baffle
355	590701	1	Starter Handle
370K	36695	1	Logo Decal 12 H.P.
371J	35703	1	Throttle Decal
380	640138	1	Carburetor (Incl. 184)
390	590746	1	Rewind Starter (NOTE: This engine could have been built with 590704 starter.)
400	36947B	1	*Gasket Set (Incl. items marked PK in notes)
420	730225A	1	SAE 30 4-Cycle Engine Oil (Quart)

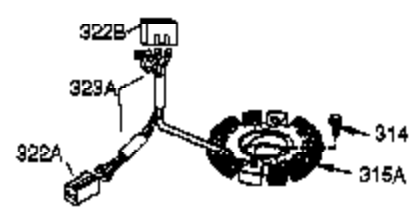
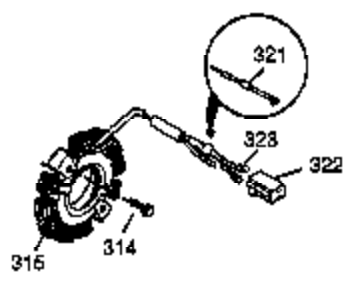
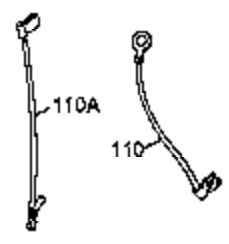
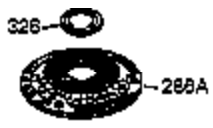
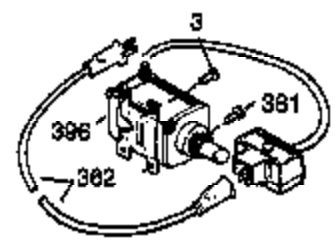
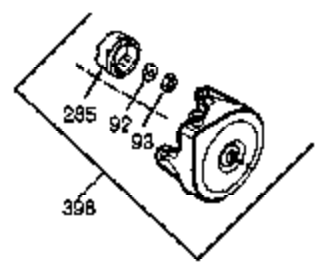
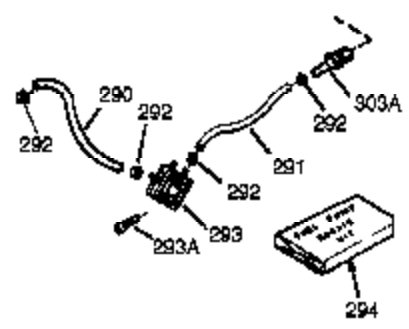
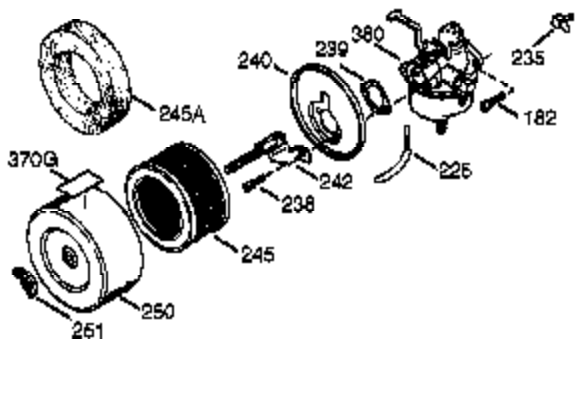

Ref #	Part Number	Qty	Description
92	650880	1	Lock Washer
93	650881	1	Flywheel Nut
110	35187	1	Ground Wire
151A	35862	1	Intake Valve Seal
163	650890	2	Lock Washer
182	650517	2	Screw, T-30, 1/4-20 x 27/32"
212A	36288	1	Bushing
233	37168	1	"O" Ring
233A	37169	1	"O" Ring
235	37167	1	Air Cleaner Elbow Fitting
238	28820	2	Screw, 10-32 x 1/2"
239	27272A	1	* Air Cleaner Gasket
240	32377	1	Air Cleaner Bracket Ass'y
242	37166	1	Air Cleaner Bracket
245A	36727	1	Air Cleaner Filter
245	31925	1	Air Cleaner Filter
250	36830	1	Air Cleaner Cover
251	650513	1	Wing Nut, 1/4-20
284	35428	1	Exhaust Deflector
284A	650760	4	Screw, 8-32 x 3/8"
285	35985B	1	Starter Cup
290	30962	1	Fuel Line
292	26460	4	Fuel Line Clamp
371J	35703	1	Throttle Decal
380	640138	1	Carburetor (Incl. 184)