

ILLUSTRATION SHOWS TYPICAL PARTS ONLY. ORDER BY PART NUMBER. PARTS NOT LISTED ARE SUPPLIED BY OEM.



Ref #	Part Number	Qty	Description
1	33883		Cylinder (Incl. 2, 4 & 56) (2-5/8" Bo re)
2	26727		Pin, Dowel
4	29183		Seal, Oil
5	30589		Rod, Governor (Incl. 6)
6	28277		Washer, Flat
7	32651		Lever, Governor
8	31335		Clamp, Governor lever (Clamp is positioned towardspark plug end on 1977-78 and latermodels. It is positioned opposite spark plugend on earlier models.)
9	650548		Screw, 8-32 x 5/16"
10	33884A		Crankshaft
11	29783		Pin, Crankshaft (Not used on late pro duction)
12	27613		Gear, Crankshaft (Not serviceable on late production)
13A	32603B		Piston & Pin Ass'y. (Incl.14)(Std.)(2 -5/8")
13A	32604B		Piston & Pin Ass'y. (Incl. 14) (.010" OS)
13A	32605B		Piston & Pin Ass'y. (Incl. 14) (.020" OS)
13	34851		Piston, Pin & Ring Set (Std.) (2-5/8" Bore)
13	34852		Piston, Pin & Ring Set (.010" OS)
13	34853		Piston, Pin & Ring Set (.020" OS)
14	20381		Ring, Piston pin retaining
15	34854		Ring Set (Std.) (2-5/8" Bore)
15	34855		Ring Set (.010" OS)
15	34856		Ring Set (.020" OS)
16	30963B		Rod Assy., Connecting (Incl. 17)
17A	26706		Bolt, Connecting rod (Early productio n)
18	20747		Washer, Connecting rod bolt (Early pr od.)
19	27573		Nut, Connecting rod, 1/4-28 (Early pr od.)
20	27241		Lifter, Valve
21	33553		Camshaft (MCR)
22	29914		Pump Assy., Oil
24	35261		* Gasket, Mounting flange
25	33898		Flange Ass'y. (Incl. 27, 28, 29 & 30)
26	28833		* Drain Plug Gasket (Not req. w/plastic plug)
27	27244		Plug, Oil drain
28	26208		Seal, Oil
29	33885		Plug, Oil drain
30	30574		Shaft, Mechanical governor
31	30590A		Washer, Flat
32	30591		Gear Assy., Governor (Incl. 31)
33	30588A		Spool, Governor
34	29193		Ring, Retaining
35	650488		Screw, 1/4-20 x 1-1/4"
36	29314B		Intake Valve (Std.) (Incl. 40)
36	29315C		Intake Valve (1/32" OS) (Incl. 40)
37	29313C		Exhaust Valve (Std.) (Incl. 40)
37	29315C		Exhaust Valve (1/32" OS) (Incl. 40)
38	31671		Cap, Upper valve spring
38A	31671		Cap, Upper valve spring (Intake)
39	31672		Spring, Valve (Exhaust)
40	31673		Cap, Lower valve spring
42	610118		Cover, Spark plug (Use as required)
43	27275		Clip, Hi tension wire
45	610961		Key, Flywheel
46	34214A		Breather Ass'y. (Incl. 47 thru 51)
47	33735		* Gasket, Breather
48	33734		Element, Breather
49	30200		Screw, 10-24 x 9/16"

Ref #	Part Number	Qty	Description
50	33886		Tube, Breather
51	33887		Clip, Breather tube
52	35182		Ground Wire
54	650561		Screw, 1/4-20 x 5/8"
55	33891B		Housing, Blower
56	650737		Screw, 1/4-20 x 1/2"
57	33015		* Gasket, Cylinder head
58	33016A		Head, Cylinder
59	26073		Washer, Flat (Not used on late production)
60	6021A		Screw, 5/16-18 x 1-1/2"
61	650697A		Screw, 5/16-18 x 2-1/2"
62	33892		Spacer
63	30593		Clip, Magneto wire
64	33636		Resistor Spark Plug (RJ-8C)
64	34251		Resistor Spark Plug (RJ-17LM)
65	27234		* Gasket, Valve spring cover
66	32755		Cover, Valve spring box
67	650128		Screw, 10-24 x 1/2"
68	32649		* Gasket, Intake pipe
69	33004A		Pipe, Intake (Incl. 68)
70	650451		Screw, 1/4-20 x 1"
71	31688		* Gasket, Carburetor
72	6201		Screw, 1/4-28 x 7/8"
73	29752		Nut & Lockwasher Assy.
74	610973		Terminal Assy. (Use as required)
76	34310		Lever, Control
77	33889A		Control Bracket (Incl. 74, 76 & 79)
79	650804		Screw, 10-24 x 9/16"
80A	28942		Screw, 10-32 x 3/8"
80	27793		Clip, Conduit
81	33133		Link, Throttle
82	33295		Link, Governor spring
83	33890		Spring, Governor
86A	30081		* Gasket, Muffler
87	34265		Gasket, Oil fill tube
89	33893A		Tube, Oil filler
90	33894A		Dipstick, Oil (Incl. 91)
91	33590		"O" Ring
92	33895		Body, Air cleaner
93	33896		Filter, Air cleaner
94	33897		Cover, Air cleaner
95	650762		Screw, 10-32 x 1-29/32"
96	650784		Screw, 10-24 x 11/16"
97	33051		* Gasket, Air cleaner
100	30705		Fuel Line (Braided 16")
101	26460		Clamp, Fuel line
102	29443		Clip, Fuel line
103	33904B		Fuel Tank (Incl. 101)
104	28763		Screw, 10-32 x 19/32"
105	730207		Magneto-to-Solid State Conversion Kit (Includes solid state module, Solid State Flywheel Key, and instructions) (Use as required on external ignition engines only)
122	650791		Washer, Flat
123	650815		Washer, Belleville
124	650607		Nut, Flywheel
137	631021		Inlet Needle, Seat & Clip Assy.

Ref #	Part Number	Qty	Description
140	631784A		Carburetor (Incl. 68, 71 & 137) (Refer to Division 5, Section A, page 140 for breakdown)
142	590450A		Side Mount Rewind Starter, (Refer to Division 5, Section C, page 27 for breakdown)
144	33906A		* Gasket Set (Incl. items marked *)

ILLUSTRATION SHOWS TYPICAL PARTS ONLY. ORDER BY PART NUMBER. PARTS NOT LISTED ARE SUPPLIED BY OEM.

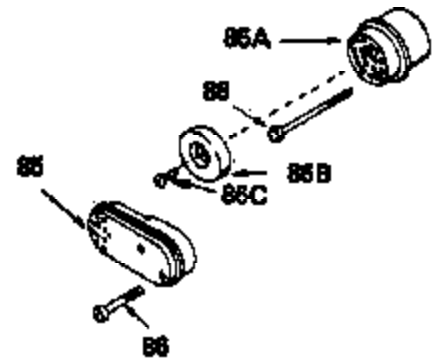
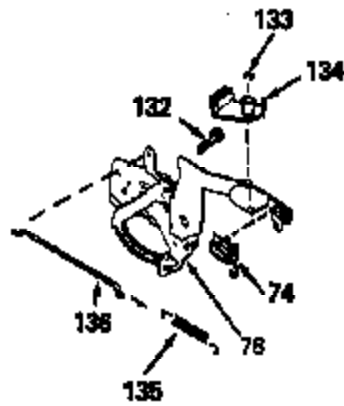

Ref #	Part Number	Qty	Description
	23 32609		Plate, Lock (Used on early production with No. 32610 connecting rod bolt. Donot use with No. 32610A locking type bolt.)
	41 650489		Screw, 1/4-20 x 5/8"
	44 33876		Gasket, Stator
	54 650561		Screw, 1/4-20 x 5/8"
	74 610973		Terminal Assy. (Use as required)
	128A 33914		Cup (Early production only, not w/650 791)
	138 30547A		Contact Assy., Breaker
	139 30548B		Condenser
	141 610793A		Magneto (w/ring gear) NOTE: The complete magneto is not available as an assembly. The magneto number is shown for reference purposes only. Order componentparts individually, as shown in parts list. (Refer to Division 5, Section B, page 35 for breakdown)
	143		Electric Starter Kit (Supplied by OEM)