

ILLUSTRATION SHOWS TYPICAL PARTS ONLY. ORDER BY PART NUMBER. PARTS NOT LISTED ARE SUPPLIED BY OEM.



Ref #	Part Number	Qty	Description
1	34429A		Cylinder (Incl. 2 & 4) (2-5/8" Bore)
2	26727		Pin, Dowel
4	32600		Seal, Oil
5	30589		Rod, Governor (Incl. 6)
6	28277		Washer, Flat
7	32651		Lever, Governor
8	31335		Clamp, Governor lever (Clamp is positioned towardspark plug end on 1977-78 and latermodels. It is positioned opposite spark plugend on earlier models.)
9	650548		Screw, 8-32 x 5/16"
10	34430		Crankshaft
11	29783		Pin, Crankshaft (Not used on late pro duction)
12	27613		Gear, Crankshaft (Not serviceable on late production)
13	34851		Piston, Pin & Ring Set (Std.) (2-5/8" Bore)
13	34852		Piston, Pin & Ring Set (.010" OS)
13	34853		Piston, Pin & Ring Set (.020" OS)
13A	32603B		Piston & Pin Ass'y. (Incl.14)(Std.)(2 -5/8")
13A	32604B		Piston & Pin Ass'y. (Incl. 14) (.010" OS)
13A	32605B		Piston & Pin Ass'y. (Incl. 14) (.020" OS)
14	20381		Ring, Piston pin retaining
15	34854		Ring Set (Std.) (2-5/8" Bore)
15	34855		Ring Set (.010" OS)
15	34856		Ring Set (.020" OS)
16	30963B		Rod Assy., Connecting (Incl. 17)
17	32610A		Bolt, Connecting rod
20	27241		Lifter, Valve
21	33553		Camshaft (MCR)
22	29914		Pump Assy., Oil
24	35261		* Gasket, Mounting flange
25	34831		Flange Ass'y. (Incl. 26, 27, 28 & 30)
26	28833		* Drain Plug Gasket (Not req. w/plastic plug)
27	27244		Plug, Oil drain
28	26208		Seal, Oil
30	30574		Shaft, Mechanical governor
31	30590A		Washer, Flat
32	30591		Gear Assy., Governor (Incl. 31)
33	30588A		Spool, Governor
34	29193		Ring, Retaining
35	650488		Screw, 1/4-20 x 1-1/4"
36	29314B		Intake Valve (Std.) (Incl. 40)
36	29315C		Intake Valve (1/32" OS) (Incl. 40)
37	29313C		Exhaust Valve (Std.) (Incl. 40)
37	29315C		Exhaust Valve (1/32" OS) (Incl. 40)
38	31671		Cap, Upper valve spring
38A	31671		Cap, Upper valve spring (Intake)
39	31672		Spring, Valve (Exhaust)
40	31673		Cap, Lower valve spring
42	610118		Cover, Spark plug (Use as required)
45	610995		Key, Flywheel
46	34214A		Breather Ass'y. (Incl. 47 thru 51)
47	33735		* Gasket, Breather
48	33734		Element, Breather
49	30200		Screw, 10-24 x 9/16"
50	33886		Tube, Breather
51	33887		Clip, Breather tube
52	34432		Ground Wire
53	30200		Screw, 10-24 x 9/16"

Ref #	Part Number	Qty	Description
54	650561		Screw, 1/4-20 x 5/8"
55	33891B		Housing, Blower
56	650737		Screw, 1/4-20 x 1/2"
57	33015		* Gasket, Cylinder head
58	34342		Head, Cylinder
59	26073		Washer, Flat (Not used on late production)
60	6021A		Screw, 5/16-18 x 1-1/2"
64	33636		Resistor Spark Plug (RJ-8C)
64	34251		Resistor Spark Plug (RJ-17LM)
65	27234		* Gasket, Valve spring cover
66	32755		Cover, Valve spring box
67	650128		Screw, 10-24 x 1/2"
68	34690		* Gasket, Intake pipe
69	33004A		Pipe, Intake (Incl. 68)
70	650451		Screw, 1/4-20 x 1"
71	31688		* Gasket, Carburetor
72	6201		Screw, 1/4-28 x 7/8"
73	29752		Nut & Lockwasher Assy.
74	610973		Terminal Assy. (Use as required)
76	34310		Lever, Control
77	33889A		Control Bracket (Incl. 74, 76 & 79)
79	650804		Screw, 10-24 x 9/16"
80A	28942		Screw, 10-32 x 3/8"
80	27793		Clip, Conduit
81	34336		Link, Throttle
82	33151		Link, Governor spring
83	33890		Spring, Governor
86A	30081		* Gasket, Muffler
87	34265		Gasket, Oil fill tube
88	650562		Screw, 10-32 x 1/2"
89	34380		Tube, Oil filler
90	33894A		Dipstick, Oil (Incl. 91)
91	33590		"O" Ring
92	33895		Body, Air cleaner
93	33896		Filter, Air cleaner
94	33897		Cover, Air cleaner
95	650762		Screw, 10-32 x 1-29/32"
96	650784		Screw, 10-24 x 11/16"
97	33051		* Gasket, Air cleaner
100	30705		Fuel Line (Braided 16")
101	26460		Clamp, Fuel line
102	29443		Clip, Fuel line
103	33904B		Fuel Tank (Incl. 101)
104	28763		Screw, 10-32 x 19/32"
105	34431		Lamination & Coil Assy. (This coil has been superseded to 730207 Solid State Conversion Kit)
105	730207		Magneto-to-Solid State Conversion Kit (Includes solid state module, Solid State Flywheel Key, and instructions) (Use as required on external ignition engines only)
106	650814		Screw, 10-24 x 1"
107	611046A		Flywheel
123	650815		Washer, Belleville
124	650816		Nut, Flywheel
137	631021		Inlet Needle, Seat & Clip Assy.
140	632050A		Carburetor (Incl. 71, 72, 95 & 137) (Refer to Division 5, Section A, page 162 for breakdown)

Ref #	Part Number	Qty	Description
142	590450A		Side Mount Rewind Starter, (Refer to Division 5, Section C, page 27 for breakdown)
144	33906A		* Gasket Set (Incl. items marked *)

ILLUSTRATION SHOWS TYPICAL PARTS ONLY. ORDER BY PART NUMBER. PARTS NOT LISTED ARE SUPPLIED BY OEM.

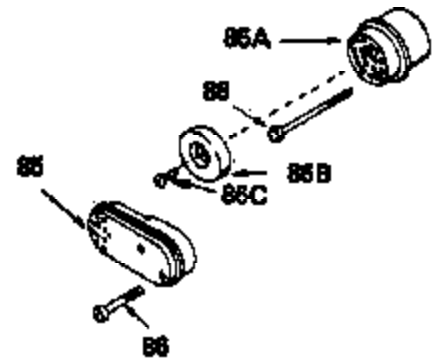
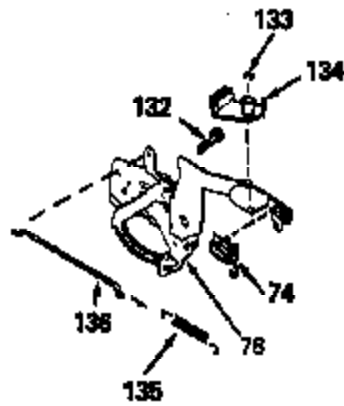

Ref #	Part Number	Qty	Description
17	32610A		Bolt, Connecting rod
23	32609		Plate, Lock (Used on early production with No. 32610 connecting rod bolt. Donot use with No. 32610A locking type bolt.)
41	650489		Screw, 1/4-20 x 5/8"
44	33876		Gasket, Stator
54	650561		Screw, 1/4-20 x 5/8"
74	610973		Terminal Assy. (Use as required)
108	30551		Spring, Breaker box cover
109	610947		Cover, Dust
110	610955		Gasket, Stator cover
111	30992		Cam, Breaker
113	610385		Washer
114	610408		Nut
115	29181		Breaker Fastening Screw & Washer
116	610593		Screw, Condenser fastening
117	33356		Terminal, Ground
120	611006		Stator (Incl.108, 113 thru 117, 121,1 38,139)
121	30549		Felt, Cam wiper
128A	33914		Cup (Early production only, not w/650 791)
138	30547A		Contact Assy., Breaker
139	30548B		Condenser
143			Electric Starter Kit (Supplied by OEM)