

ILLUSTRATION SHOWS TYPICAL PARTS ONLY. ORDER BY PART NUMBER. PARTS NOT LISTED ARE SUPPLIED BY OEM.



Ref #	Part Number	Qty	Description
1	33899A		Cylinder (Incl. 2, 4 & 56) (2-13/16" Bore)
2	26727		Pin, Dowel
4	32600		Seal, Oil
5	30589		Rod, Governor (Incl. 6)
6	28277		Washer, Flat
7	32651		Lever, Governor
8	31335		Clamp, Governor lever (Clamp is positioned towardspark plug end on 1977-78 and latermodels. It is positioned opposite spark plugend on earlier models.)
9	650548		Screw, 8-32 x 5/16"
10	34469		Crankshaft
11	29783		Pin, Crankshaft (Not used on late pro duction)
12	27613		Gear, Crankshaft (Not serviceable on late production)
13A	33562B		Piston & Pin Ass'y.(Incl.14)(Std.)(2- 13/16")
13A	33563B		Piston & Pin Ass'y. (Incl. 14) (.010" OS)
13A	33564B		Piston & Pin Ass'y. (Incl. 14) (.020" OS)
13	34535		Piston, Pin & Ring Set (Std.) (2-13/1 6" Bore)
13	34536		Piston, Pin & Ring Set (.010" OS)
13	34537		Piston, Pin & Ring Set (.020" OS)
14	20381		Ring, Piston pin retaining
15	33567		Ring Set (Std.) (2-13/16" Bore)
15	33568		Ring Set (.010" OS)
15	33569		Ring Set (.020" OS)
17	32610A		Bolt, Connecting rod
20	27241		Lifter, Valve
21	33553		Camshaft (MCR)
22	29914		Pump Assy., Oil
24	35261		* Gasket, Mounting flange
25	34311B		Flange Ass'y. (Incl. 27, 28, 29 & 30)
26	28833		* Drain Plug Gasket (Not req. w/plastic plug)
27	27244		Plug, Oil drain
28	27897		Seal, Oil
30	30574		Shaft, Mechanical governor
31	30590A		Washer, Flat
32	31947		Gear Assy., Governor
33	33903		Spool, Governor
34	29193		Ring, Retaining
35	650488		Screw, 1/4-20 x 1-1/4"
36	29314B		Intake Valve (Std.) (Incl. 40)
36	29315C		Intake Valve (1/32" OS) (Incl. 40)
37	29313C		Exhaust Valve (Std.) (Incl. 40)
37	29315C		Exhaust Valve (1/32" OS) (Incl. 40)
38	31671		Cap, Upper valve spring
38A	31671		Cap, Upper valve spring (Intake)
39	31672		Spring, Valve (Exhaust)
40	31673		Cap, Lower valve spring
42	610118		Cover, Spark plug (Use as required)
45	610995		Key, Flywheel
46	34214A		Breather Ass'y. (Incl. 47 thru 51)
47	33735		* Gasket, Breather
48	33734		Element, Breather
49	30200		Screw, 10-24 x 9/16"
50	33886		Tube, Breather
51	33887		Clip, Breather tube
52	34459		Ground Wire
53	30200		Screw, 10-24 x 9/16"
54	650561		Screw, 1/4-20 x 5/8"

Ref #	Part Number	Qty	Description
57	33554		* Gasket, Cylinder head
58	34342		Head, Cylinder
59	26073		Washer, Flat (Not used on late production)
60	6021A		Screw, 5/16-18 x 1-1/2"
64	33636		Resistor Spark Plug (RJ-8C)
64	34251		Resistor Spark Plug (RJ-17LM)
65	27234		* Gasket, Valve spring cover
66	32755		Cover, Valve spring box
67	650128		Screw, 10-24 x 1/2"
68	32649		* Gasket, Intake pipe
69	33004A		Pipe, Intake (Incl. 68)
70	650451		Screw, 1/4-20 x 1"
71	31688		* Gasket, Carburetor
72	6201		Screw, 1/4-28 x 7/8"
73	29752		Nut & Lockwasher Assy.
74	610973		Terminal Assy. (Use as required)
81	34336		Link, Throttle
82	33151		Link, Governor spring
83	31361		Spring, Governor
83A	33086		Lever, Speed adjusting
84	33932		Terminal
86A	30081		* Gasket, Muffler
87	34265		Gasket, Oil fill tube
88	650562		Screw, 10-32 x 1/2"
89	34380		Tube, Oil filler
90	33894A		Dipstick, Oil (Incl. 91)
91	33590		"O" Ring
92	33895		Body, Air cleaner
93	33896		Filter, Air cleaner
94	33897		Cover, Air cleaner
95	650762		Screw, 10-32 x 1-29/32"
96	650784		Screw, 10-24 x 11/16"
97	33051		* Gasket, Air cleaner
100	30705		Fuel Line (Braided 16")
101	26460		Clamp, Fuel line
102	29443		Clip, Fuel line
103	33904B		Fuel Tank (Incl. 101)
104	28763		Screw, 10-32 x 19/32"
105	730207		Magneto-to-Solid State Conversion Kit (Includes solid state module, Solid State Flywheel Key, and instructions) (Use as required on external ignition engines only)
105	34431		Lamination & Coil Assy. (This coil has been superseded to 730207 Solid State Conversion Kit)
106	650814		Screw, 10-24 x 1"
107	611050		Flywheel
123	650815		Washer, Belleville
124	650816		Nut, Flywheel
128	34461		Pulley, Starter
137	631021		Inlet Needle, Seat & Clip Assy.
140	632050		Carburetor (Incl. 71, 72, 95 & 137) (Refer to Division 5, Section A, page A2-10 for breakdown)
144	33906A		* Gasket Set (Incl. items marked *)

ILLUSTRATION SHOWS TYPICAL PARTS ONLY. ORDER BY PART NUMBER. PARTS NOT LISTED ARE SUPPLIED BY OEM.

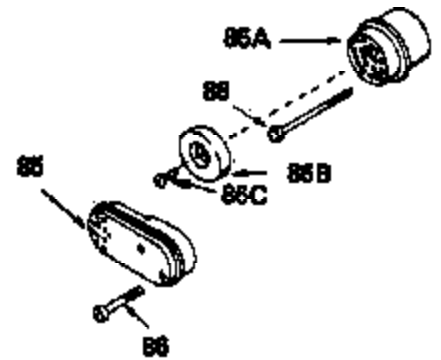
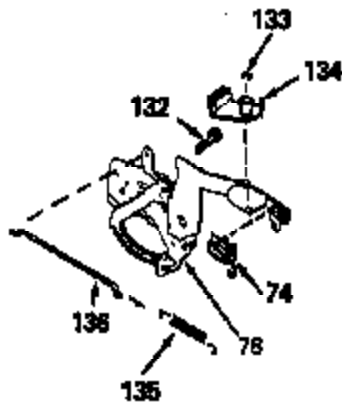
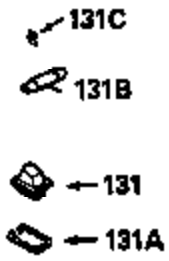

Ref #	Part Number	Qty	Description
	3 32323		Washer, Thrust
	16A 32875		Rod Assy., Connecting (Incl. 17)
	17 32610A		Bolt, Connecting rod
	23 32609		Plate, Lock (Used on early production with No. 32610 connecting rod bolt. Donot use with No. 32610A locking type bolt.)
	41 650489		Screw, 1/4-20 x 5/8"
	44 33876		Gasket, Stator
	54 650561		Screw, 1/4-20 x 5/8"
	55A 33907A		Housing, Blower
	74 610973		Terminal Assy. (Use as required)
	108 30551		Spring, Breaker box cover
	109 610947		Cover, Dust
	110 610955		Gasket, Stator cover
	111 30992		Cam, Breaker
	113 610385		Washer
	114 610408		Nut
	115 29181		Breaker Fastening Screw & Washer
	116 610593		Screw, Condenser fastening
	117 33356		Terminal, Ground
	120 611006		Stator (Incl.108, 113 thru 117, 121,1 38,139)
	121 30549		Felt, Cam wiper
	127 590343		Rope Assy., Starter
	128A 33914		Cup (Early production only, not w/650 791)
	138 30547A		Contact Assy., Breaker
	139 30548B		Condenser
	143		Electric Starter Kit (Supplied by OEM)