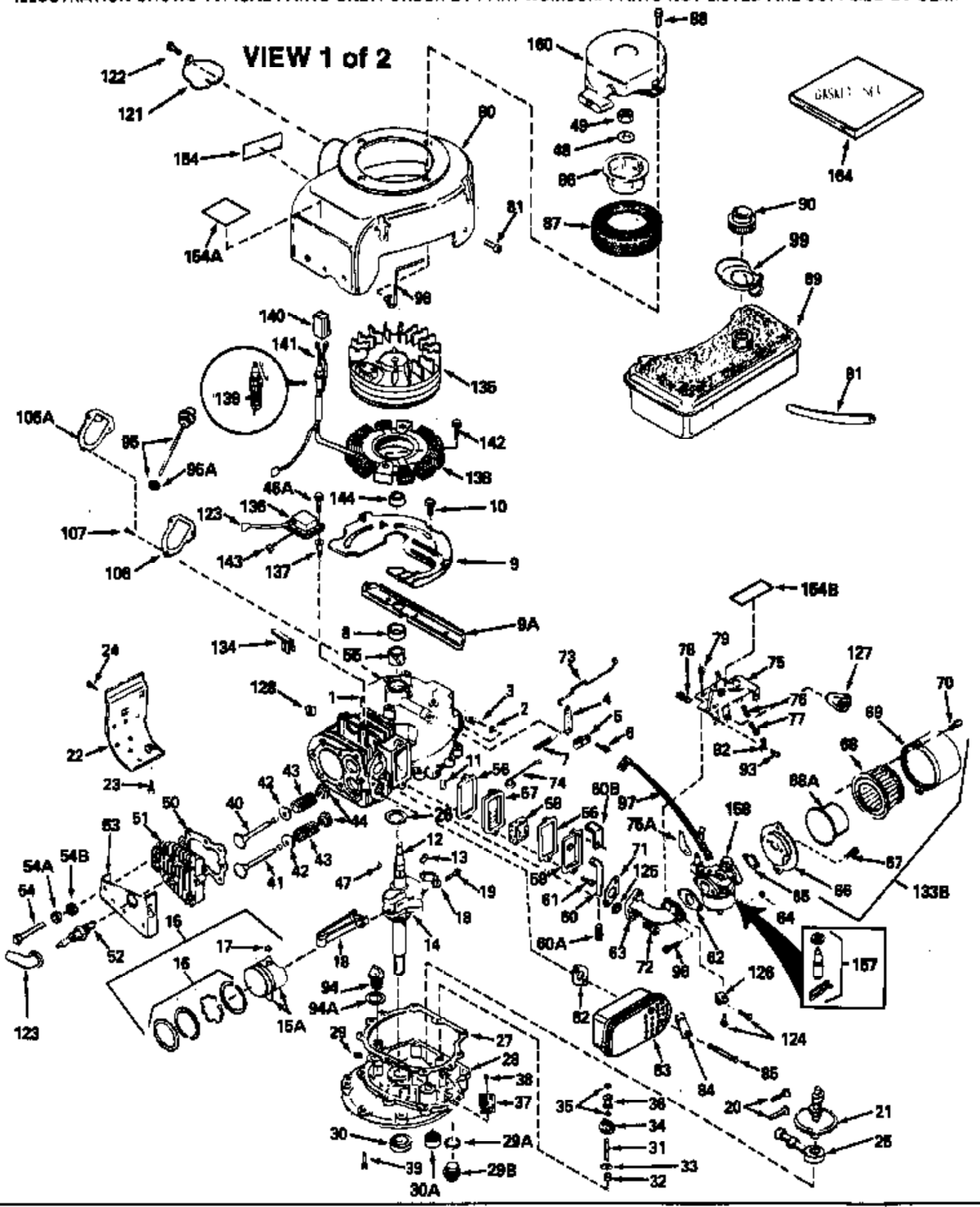

ILLUSTRATION SHOWS TYPICAL PARTS ONLY. ORDER BY PART NUMBER. PARTS NOT LISTED ARE SUPPLIED BY OEM.



Ref #	Part Number	Qty	Description
1	34913A		Cylinder (Incl. 8, 11, 94 & 94A) (2-5/8")
2	28277		Washer, Flat
3	30669		Rod, Governor
4	31357		Lever, Governor
5	31335		Clamp, Governor lever
6	650548		Screw, 8-32 x 5/16"
7	31361		Spring, Governor
8	32630		Seal, Oil
9	29536		Baffle, Blower housing (Use as required)
9	35256A		Blo.Hsg.Baffle (W/E.S.knock-out)(As required)
10	650561		Screw, 1/4-20 x 5/8"
11	27652		Pin, Dowel
12	35196		Crankshaft (Incl. 13 & 14)
13	29783		Pin, Crankshaft gear
14	27884		Gear, Crankshaft
15A	33312B		Piston & Pin Ass'y. (Incl.17)(2-5/8") (Std.)
15A	33313B		Piston & Pin Ass'y. (Incl. 17) (.010" OS)
15A	33314B		Piston & Pin Ass'y. (Incl. 17) (.020" OS)
15	34531		Piston, Pin & Ring Set (2-5/8") (Std.)
15	34532		Piston, Pin & Ring Set (.010" OS)
15	34533		Piston, Pin & Ring Set (.020" OS)
16	34854		Ring Set (2-5/8") (Std.)
16	34855		Ring Set (.010" OS)
16	34856		Ring Set (.020" OS)
17	27888		Ring, Piston pin retaining
18	31380C		Rod Assy., Connecting (Incl. 19)
19	650662C		Bolt, Connecting rod (Incl. 2 pieces)
20	34034		Lifter, Valve
21	32114		Camshaft (MCR)
22	30622A		Extension, Blower housing
23	650128		Screw, 10-24 x 1/2"
24	30688		Screw, 1/4-20 x 1/2"
25	31356		Pump Assy., Oil
27	30684		* Gasket, Cylinder cover
28	31471C		Flange Ass'y. (Incl. 29,30,31,33,182 & 183)
29	27642		Plug, Pipe (sq.hd, 1/4-28)
30	27897		Seal, Oil
31	30668		Shaft, Mech. Governor
32	31707A		Governor Spacer Assy. (Incl. 33)
33	30590A		Washer, Flat (2 required)
34	30591		Gear Assy., Governor
35	29193		Ring, Retaining
36	30588A		Spool, Governor
37	31355		Screen, Oil filter (Use as required)
38	29117		Screw, 8-32 x 5/16" (Use as required)
39	650488		Screw, 1/4-20 x 1-1/4"
40	32783		Intake Valve (Std.) (Incl. 44)
40	32784		Intake Valve (1/32" OS) (Incl. 44)
41	27878A		Exhaust Valve (Std.) (Incl. 44)
41	27880A		Exhaust Valve (1/32" OS) (Incl. 44)
42	27882		Cap, Upper valve spring
43	27881		Spring, Valve
44	32581		Cap, Lower valve spring
46A	650814		Screw, 10-24 x 1"
47	32589		Key, Flywheel
48	650815		Washer, Belleville
49	8116		Nut, Washer, 1/2-20
50	28938B		* Gasket, Head

Ref #	Part Number	Qty	Description
51	30938A		Head, Cylinder (Incl. 54)
52	33636		Resistor Spark Plug (RJ-8)
52	34251		Resistor Spark Plug (RJ-17LM)
53	30939A		Cover Assy., Cylinder head
54B	650691		Washer, Flat (Use as required)
54	650694A		Screw, 5/16-18 x 2" (Use as required)
54	650697A		Screw, 5/16-18 x 2-1/2" (Use as required)
54A	26073		Washer, Flat (Use as required)
54A	650690		Washer, Belleville (Use as required)
56	27896		* Gasket, Breather cover
57	28423		Body, Breather
58	28424		Element, Breather
59	28425		Cover, Valve spring box
60	27627		Tube, Breather
61	650128		Screw, 10-24 x 1/2"
62	26756		* Gasket, Carburetor
63	32632		Pipe, Intake
65	27272		* Gasket, Air cleaner
66	31691		Bracket, Air cleaner
67	28820		Screw, 10-32 x 1/2"
68	30727		Element, Air cleaner
69	31715		Body, Air cleaner
70	650152		Screw, 8-32 x 3/8"
71	27915		* Gasket, Intake to cylinder
72	650378		Screw, 5/16-18 x 1-1/8"
73	31823		Link, Throttle
74	32582		Link, Governor spring
75	32181A		Control Assy., Speed (Incl. 76, 77 & 78)
76	31342		Spring, Compression
77	650549		Screw, 5-40 x 7/16"
78	610973		Terminal Ass'y. (Use as required)
79	30200		Screw, 10-24 x 9/16"
80	32629B		Blower Housing (Incl. 121 & 122)(Elec. Str.)
81	29747B		Screw, 5/16-24 x 21/32"
82	27930		* Gasket, Exhaust
83	28269		Muffler
84	31588		Plate, Muffler locking
85	30196		Screw, 5/16-18 x 3/4" (Use as required)
85	650696		Screw, 5/16-18 x 2-3/4" (Use as required)
85	650697A		Screw, 5/16-18 x 2-1/2" (Use as required)
86	32125		Cup, Starter
87	35009		Screen, Starter
88	29716		Screw, 1/4-28 x 7/16"
89	32584		Fuel Tank (Incl. 90)
90	33032		Fuel Cap (Use as required)
90	34210		Fuel Cap (Use as required)
91	29774		Fuel Line (8-1/4") (Use as required)
91	30962		Fuel Line (32") (Use as required)
92	27793		Clip, Conduit
93	28942		Screw, 10-32 x 3/8"
95	34165		Dipstick (Incl. 95A)
95A	29673		* Gasket, Oil fill
96	6201		Screw, 1/4-28 x 7/8" (Use as required)
96	650372		Screw, 1/4-20 x 13/16" (Use as required)
97	35182		Wire, Ground
98	33549		Clamp, Tank hold down
115	33323		Screen, Muffler (Use as required)
123	27276		Cover, Spark plug (Use as required)

Ref #	Part Number	Qty	Description
123	610118		Cover, Spark plug (Use as required)
133B	730127		A/C Assy. (Incl.65,66,67,68A,69,70,13 4)
134	29443		Clip, Fuel line
135	611084		Flywheel
136	34443A		Solid State Assy.
137	650872		Stud, Solid State mounting
154	34346		Decal, Instruction
154A	550223		Decal, Name
157	631021		Inlet Needle, Seat & Clip Assy.
158	632233		Carburetor (Incl. 62) (Refer to Division 5, Section A, page 182 for breakdown)
160	590420		Rewind Starter (Refer to Division 5, Section C, page 25 for breakdown)
164	33234A		* Gasket Set (Incl. items marked *)

ILLUSTRATION SHOWS TYPICAL PARTS ONLY. ORDER BY PART NUMBER. PARTS NOT LISTED ARE SUPPLIED BY OEM.

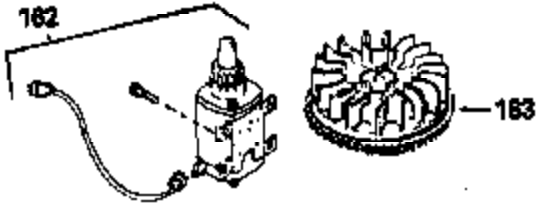

OPTIONAL 110 - 120 VOLT
 STARTER MOTOR KIT

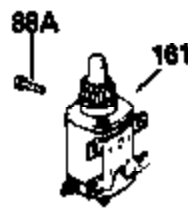

VIEW 2 of 2

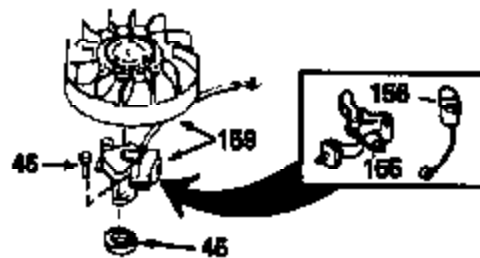
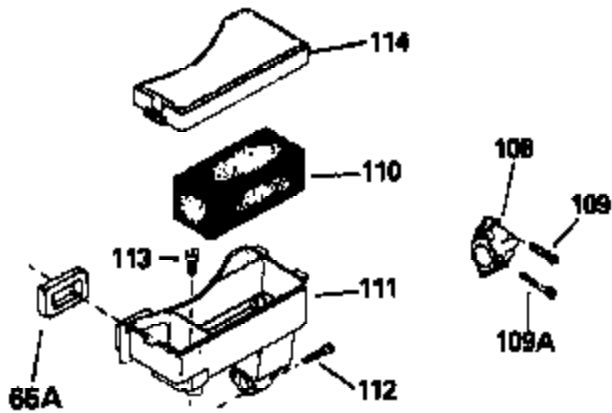
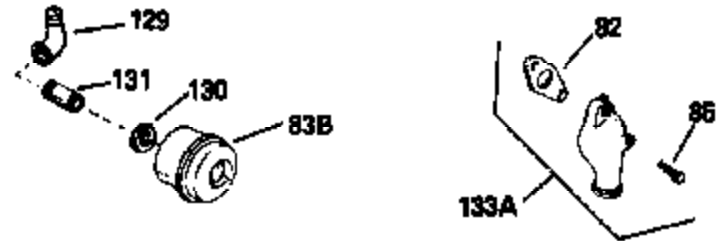
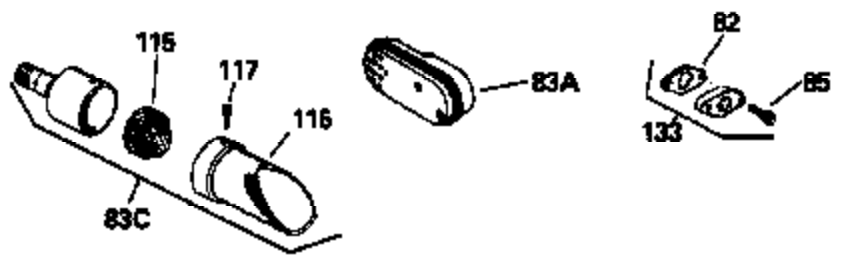
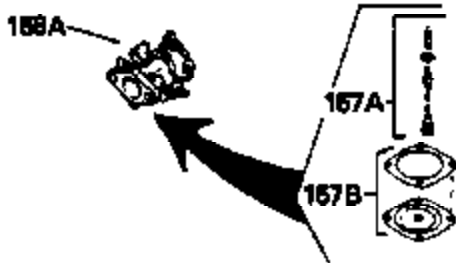

STD. POINT

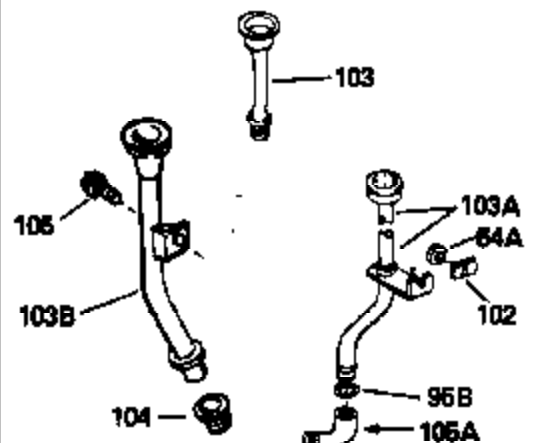
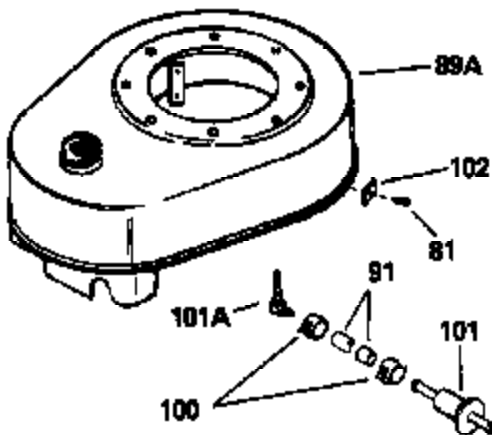

Ref #	Part Number	Qty	Description
54A	26073		Washer, Flat (Use as required)
54A	650690		Washer, Belleville (Use as required)
81	29747B		Screw, 5/16-24 x 2 1/32"
82	27930		* Gasket, Exhaust
83C	391026		Muffler (Incl. 115, 116 & 117) (This spark arrestor muffler can be used on any model)
85	30196		Screw, 5/16-18 x 3/4" (Use as required)
85	650696		Screw, 5/16-18 x 2-3/4" (Use as required)
85	650697A		Screw, 5/16-18 x 2-1/2" (Use as required)
91	29774		Fuel Line (8-1/4") (Use as required)
91	30962		Fuel Line (32") (Use as required)
100	26460		Clamp, Fuel line (Use as required)
115	33323		Screen, Muffler (Use as required)
116	33700		Cover & tube, Muffler (Use as required)
117	650578		Screw, 8-18 x 3/8" (Use as required)
133A	31288		Muffler Adapter Kit (Incl. 82 & 85) (As req.)
133	730130		Muffler Adap. Kit (Incl. 82 & 85) (As req.)
162	33329D		Starter Motor Kit (110-120 volt) (Refer to service number stamped on end cap of motor, or on decal, for identification. For breakdown see Division 5, Section D, Page 16.)
163	611042		Flywheel (Ring gear flywheel required on engines using 110-120 volt starter motor kits listed above) (Use on Std. point ignitions)
163	611085		Flywheel (Ring gear flywheel required on engines using 110-120 volt starter motor kits listed above) (Use on solid state ignitions)