

VIEW 1 OF 3

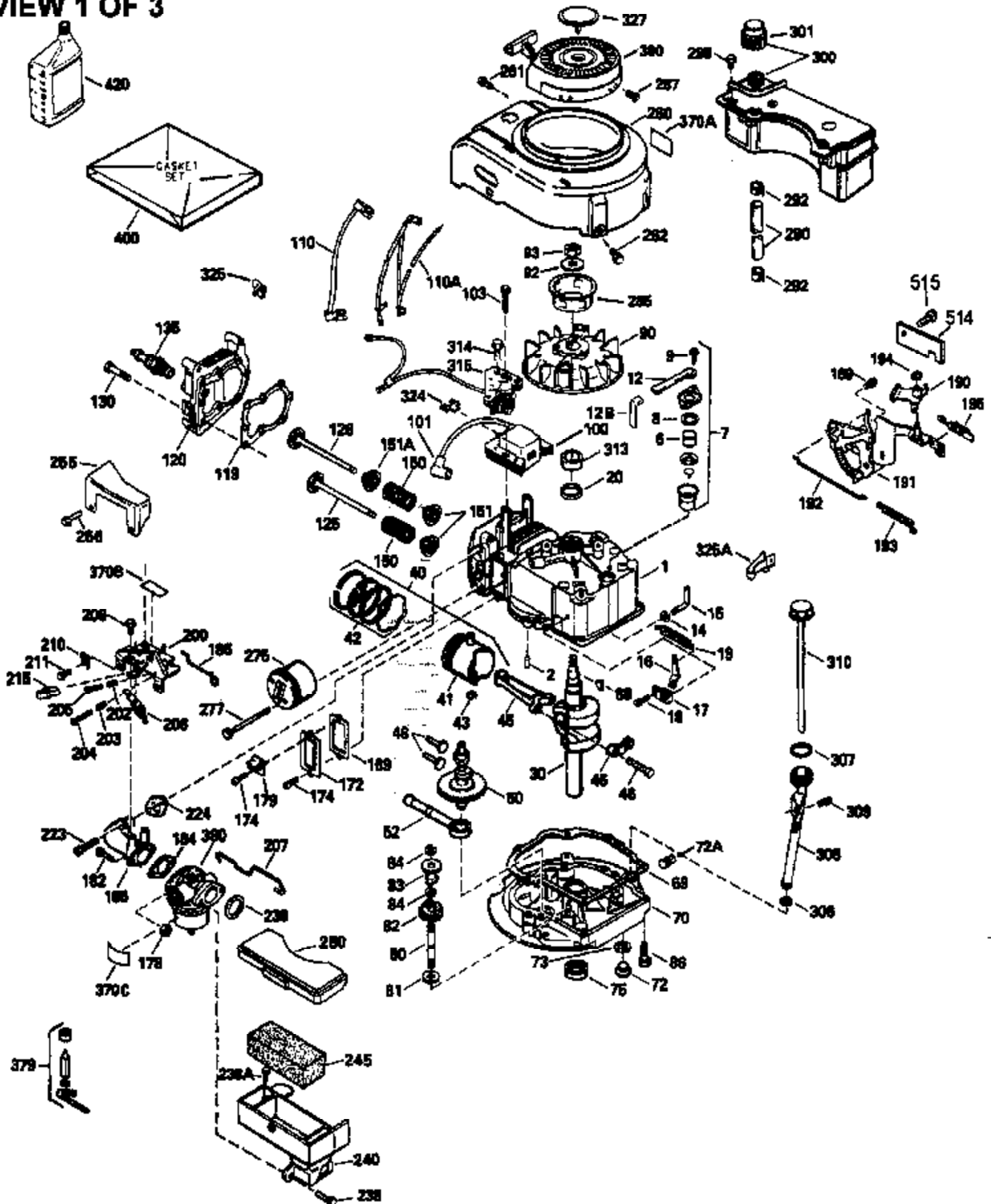

Ref #	Part Number	Qty	Description
1	35010		Cylinder (Incl. 2 & 20)(2-5/8" Bore)
2	26727		Pin, Dowel
12	33886		Tube, Breather
14	28277		Washer, Flat
15	30589		Rod, Governor (Incl. 14)
16	31383A		Lever, Governor
17	31335		Clamp, Governor lever
18	650548		Screw, 8-32 x 5/16"
19	31361		Spring, Extension
20	32600		Seal, Oil
30	32888B		Crankshaft
32	32323		Washer, Thrust NOTE: This thrust washer maynot be required if a new crankshafthas been installed. Check the proper Mechanic's Handbook for acceptable end play. Use this .010" thrust washer if excess end play is measured.
40	34851		Piston, Pin & Ring Set (Std.) (2-5/8" Bore) NOTE: These piston, pin andring sets and pistons have been superceded into a new piston, pin and ring set assembly. As of this update the ring sets (34854, 34855, 34856) are stillavailable. It will be necessary to note on the engine that the piston, pin
40	34852		Piston, Pin & Ring Set (.010" OS)
40	34853		Piston, Pin & Ring Set (.020" OS)
41	32603B		Piston & Pin Ass'y. (Incl.43)(Std.)(2 -5/8")
41	32604B		Piston & Pin Ass'y. (Incl. 43) (.010" OS)
41	32605B		Piston & Pin Ass'y. (Incl. 43) (.020" OS)
42	34854		Ring Set (Std.) (2-5/8" Bore)
42	34855		Ring Set (.010" OS)
42	34856		Ring Set (.020" OS)
43	20381		Ring, Piston pin retaining
45	32875		Rod Assy., Connecting (Incl. 46)
46	32610A		Bolt, Connecting rod
48	27241		Lifter, Valve
50	33148A		Camshaft
52	29914		Oil Pump Assy.
69	35261		* Gasket, Mounting flange
70	34311C		Flange Ass'y. (Incl. 72, 72A, 73, 75 & 80)
72	30572		Plug, Oil drain (Incl. 73)
73	28833		* Drain Plug Gasket (Not req. W/plastic plug)
75	27897		Seal, Oil
80	30574		Shaft, Governor
81	30590A		Washer, Flat
82	30591		Gear Assy., Governor (Incl. 81)
83	30588A		Spool, Governor
84	29193		Ring, Retaining
86	650488		Screw, 1/4-20 x 1-1/4"
89	610951		Flywheel Key
92	650815		Washer, Belleville
92A	650791		Washer, Flat
93	650607		Nut, Flywheel
100	730207		Magneto-to-Solid State Conv. Kit (Includes solid state module, solid state flywheel key, and instructions.) (Use as required on external ignition engines only.)
101	610118		Cover, Spark plug (Use as required)
103	650489		Screw, 1/4-20 x 5/8"
110	34231		Ground Wire
118	730194		Rope Guide Kit (Use as required)

Ref #	Part Number	Qty	Description
119	33015A	*	Gasket, Head
120	34342		Head, Cylinder
125	29314B		Intake Valve (Std.) (Incl. 151) (Conventional Ports)
125	29315C		Intake Valve (1/32" OS) (Incl. 151) (Conventional Ports)
125	29313C		Exhaust Valve (Std.) (Incl. 151) (Inverted Ports)
126	29313C		Exhaust Valve (Std.) (Incl. 151) (Conventional Ports)
126	29315C		Exhaust Valve (1/32" OS) (Incl. 151) (Conventional Ports)
126	34776		Exhaust Valve (Std.) (Incl. 151) (Conventional Ports)
126	32644A		Intake Valve (Incl. 151) (Inverted Ports)
130	6021A		Screw, 5/16-18 x 1-1/2" (Use as required)
130	650697A		Screw, 5/16-18 x 2-1/2" (Use as required)
135	33636		Resistor Spark Plug
150	31672		Spring, Valve
151	31673		Cap, Lower valve spring
169A	31619A	*	Gasket, Breather
170	31337A		Breather Assy. (Incl. 169A & 171)
171	31410		Element, Breather
174	650128		Screw, 10-24 x 1/2"
178	29752		Nut & Lockwasher, 1/4-28
179	30593		Clip, Wire
182	6201		Screw, 1/4-28 x 7/8"
184	26756	*	Gasket, Carburetor
186	34337		Link, Governor spring
200	33131A		Control Bracket (Incl. 202 thru 206)
202	33802		Spring, Compression
203	31342		Spring, Compression
204	650549		Screw, 5-40 x 7/16"
205	650777		Screw, 6-32 x 21/32"
206	610973		Terminal (Use as required)
207	34336		Link, Throttle
209	30200		Screw, 10-24 x 9/16"
210	27793		Clip, Conduit
211	28942		Screw, 10-32 x 3/8"
223	650451		Screw, 1/4-20 x 1"
224	32649A		Gasket, Intake pipe
238	650806		Screw, 10-32 x 5/8"
239	34338	*	Gasket, Air cleaner
240	34339		Body, Air cleaner
246	34340		Element, Air cleaner
246E	35435		Filter, Pre-air (Use as required)
250	34341A		Cover, Air cleaner
260	34345		Housing, Blower
261	30200		Screw, 10-24 x 9/16"
262	650831		Screw, 1/4-20 x 15/32"
275	27181B		Muffler Kit (Incl. 274 & 277)
277	650795		Screw, 1/4-20 x 2-1/4" (Use as required)
277	650774		Screw, 1/4-20 x 2-3/8" (Use as required)
277	792005		Screw, 1/4-20 x 2-1/2" (Use as required)
287	650802		Screw, 1/4-20 x 5/8"
290	34357		Fuel Line (Epichlorohydrin 6-3/4")(17 cm)
290	29774		Fuel Line(Braided 8-1/4")(21 cm)(Use as req.)
290	30705		Fuel Line (Braided 16")(40 cm)(Use as req.)
290	30962		Fuel Line (Braided 32")(81 cm)(Use as req.)
292	26460		Clamp, Fuel line
300	32170A		Fuel Tank (Incl. 292 & 301)
301	33032		Fuel Cap (Use as required)
305	34264		Oil Fill Tube
306	34265		Gasket, Oil fill tube

Ref #	Part Number	Qty	Description
306	34282		"O" Ring (This "O" ring is required with metal fill tube only when replacement mounting flange with .777 dia. oil fill hole has been used.)
307	33590		"O" Ring
309	650562		Screw, 10-32 x 1/2"
310	34267		Oil Dipstick (Incl. 150)
313A	33876		Gasket, Stator
325	27275		Clip, Hi-tension wire
326	34113		Plug, Screen
370H	34387		Decal, Instruction (Optional)
370J	34870		Decal, Instruction (Optional)
370B	34363		Decal, Instruction
370A	34346		Decal, Instruction
375	610964		Magneto (W/ring gear) Note: The complete magneto is not available as an assembly. The magneto number is for reference purposes only. Order component parts individually, as shown in the breakdown. (Refer to Division 5, Section B, page 35 or Fiche 8A, Grid G-1 for breakdown)
377	30547A		Contact Assy., Breaker
378	30548B		Condenser
379	631021		Inlet Needle, Seat & Clip Assy.
380	632078A		Carburetor (Incl. 184) (Refer to Division 5, Section A, page A2-10 or Fiche 8A, Grid E-13 for breakdown)
390A	590531		Side Mount Rewind Starter (Refer to Division 5, Section C, page 32 or Fiche 8A, Grid G-3 for breakdown)
400	33238D		* Gasket Set (Incl. items marked *)
420	730225		SAE 30, 4-Cycle Engine Oil (Quart)
425	730571		Starter Muff Kit (Incl.370J,426,427)(Opt.)
426	32203		Starter Air Cleaner (Optional)
427	32204		Starter Air Cleaner Bracket (Optional)
436	611006		Stator Plate Ass'y.(Incl.377,378,437, 442-448)
437	30551		Spring, Breaker box cover
438	610947		Cover, Dust
439	610955		Gasket, Stator cover
440	30992		Cam, Breaker
442	610385		Washer
443	610408		Nut, 8-32
444	29181		Breaker Fastening Screw & Washer
445	610593		Condenser Fastening Screw
446	33356		Terminal, Ground

VIEW 2 OF 3

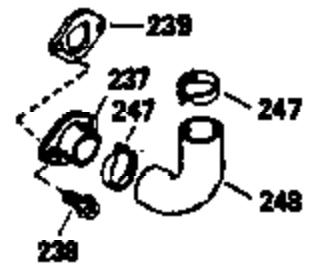
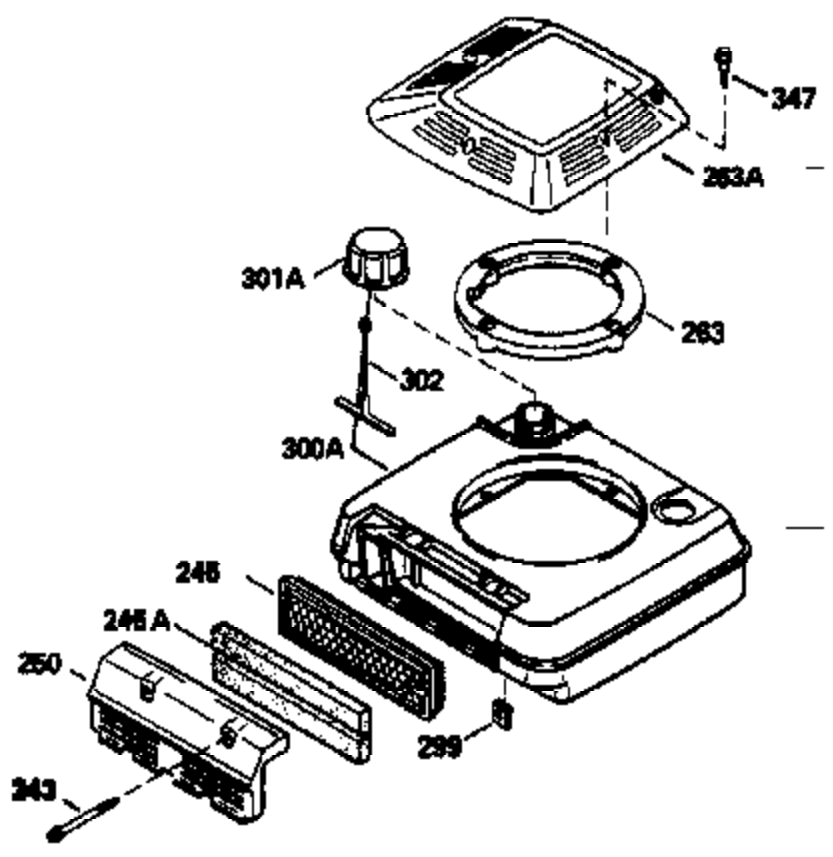
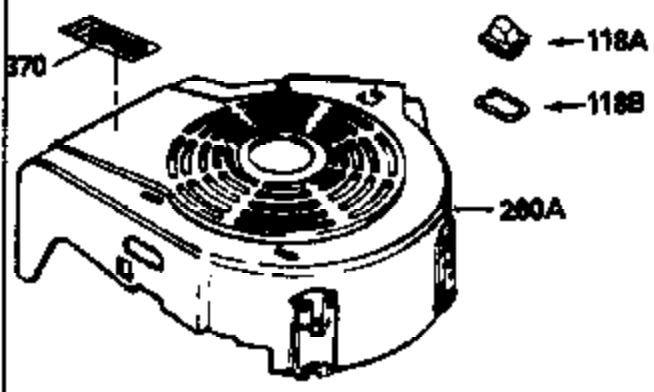

Ref #	Part Number	Qty	Description
32	32323		Washer, Thrust NOTE: This thrust washer maynot be required if a new crankshafthas been installed. Check the proper Mechanic's Handbook for acceptable end play. Use this .010" thrust washer if excess end play is measured.
92A	650791		Washer, Flat
118	730194		Rope Guide Kit (Use as required)
169A	31619A		* Gasket, Breather
170	31337A		Breather Assy. (Incl. 169A & 171)
171	31410		Element, Breather
238	650806		Screw, 10-32 x 5/8"
239	34338		* Gasket, Air cleaner
246	34340		Element, Air cleaner
246E	35435		Filter, Pre-air (Use as required)
250	34341A		Cover, Air cleaner
287A			Pop Rivet (3/16" Dia.) (Purchase loca lly)
287A	650735		Screw, 10-24 x 3/8" (Use as required)
313A	33876		Gasket, Stator
326	34113		Plug, Screen
370H	34387		Decal, Instruction (Optional)
370J	34870		Decal, Instruction (Optional)
370	550223		Decal, Name
375	610964		Magneto (W/ring gear) Note: The complete magneto is not available as an assembly. The magneto number is for reference purposes only. Order component parts individually, as shown in the breakdown. (Refer to Division 5, Section B, page 35 or Fiche 8A, Grid G-1 for breakdown)
377	30547A		Contact Assy., Breaker
378	30548B		Condenser
390A	590531		Side Mount Rewind Starter (Refer to Division 5, Section C, page 32 or Fiche 8A, Grid G-3 for breakdown)
425	730571		Starter Muff Kit (Incl.370J,426,427)(Opt.)
426	32203		Starter Air Cleaner (Optional)
427	32204		Starter Air Cleaner Bracket (Optional)
436	611006		Stator Plate Ass'y.(Incl.377,378,437, 442-448)
437	30551		Spring, Breaker box cover
438	610947		Cover, Dust
439	610955		Gasket, Stator cover
440	30992		Cam, Breaker
442	610385		Washer
443	610408		Nut, 8-32
444	29181		Breaker Fastening Screw & Washer
445	610593		Condenser Fastening Screw
446	33356		Terminal, Ground

VIEW 3 OF 3



Ref #	Part Number	Qty	Description
19	31361		Spring, Extension
32	32323		Washer, Thrust NOTE: This thrust washer maynot be required if a new crankshafthas been installed. Check the proper Mechanic's Handbook for acceptable end play. Use this .010" thrust washer if excess end play is measured.
69	35261		* Gasket, Mounting flange
92A	650791		Washer, Flat
118	730194		Rope Guide Kit (Use as required)
169A	31619A		* Gasket, Breather
170	31337A		Breather Assy. (Incl. 169A & 171)
171	31410		Element, Breather
182	6201		Screw, 1/4-28 x 7/8"
185	31384A		Pipe, Intake (Incl. 224)
186	34337		Link, Governor spring
206	610973		Terminal (Use as required)
209	30200		Screw, 10-24 x 9/16"
223	650451		Screw, 1/4-20 x 1"
238	650806		Screw, 10-32 x 5/8"
239	34338		* Gasket, Air cleaner
240	34339		Body, Air cleaner
246	34340		Element, Air cleaner
246E	35435		Filter, Pre-air (Use as required)
250	34341A		Cover, Air cleaner
274	26754A		* Gasket, Exhaust (Use as required)
277	650795		Screw, 1/4-20 x 2-1/4" (Use as requir ed)
277	650774		Screw, 1/4-20 x 2-3/8" (Use as requir ed)
277	792005		Screw, 1/4-20 x 2-1/2" (Use as requir ed)
277A	30063		Screw, Torx T-30, 1/4-20 x 1/2" (Use as req.)
313A	33876		Gasket, Stator
326	34113		Plug, Screen
370J	34870		Decal, Instruction (Optional)
370H	34387		Decal, Instruction (Optional)
375	610964		Magneto (W/ring gear) Note: The complete magneto is not available as an assembly. The magneto number is for reference purposes only. Order component parts individually, as shown in the breakdown. (Refer to Division 5, Section B, page 35 or Fiche 8A, Grid G-1 for breakdown)
377	30547A		Contact Assy., Breaker
378	30548B		Condenser
390A	590531		Side Mount Rewind Starter (Refer to Division 5, Section C, page 32 or Fiche 8A, Grid G-3 for breakdown)
410	730574		Debris Screen Kit(Incl.370H,411-413)(Opt.)
411	35596		Screen, Debris (Optional)
412	35597		Bracket, Debris screen (Optional)
413	650910		Screw, 8-32 x 1/4 (Optional)
415	730162		Muffler Adapter Kit(Incl.274,277)(Use as req)
425	730571		Starter Muff Kit (Incl.370J,426,427)(Opt.)
426	32203		Starter Air Cleaner (Optional)
427	32204		Starter Air Cleaner Bracket (Optional)
436	611006		Stator Plate Ass'y.(Incl.377,378,437, 442-448)
437	30551		Spring, Breaker box cover
438	610947		Cover, Dust
439	610955		Gasket, Stator cover
440	30992		Cam, Breaker
442	610385		Washer
443	610408		Nut, 8-32

Ref #	Part Number	Qty	Description
444	29181		Breaker Fastening Screw & Washer
445	610593		Condenser Fastening Screw
446	33356		Terminal, Ground