

Ref #	Part Number	Qty	Description
	1 36470A	1	Cylinder (Incl. 2,7,20,125,169,172,17 4)
	2 26727	2	Dowel Pin
	6 33734	1	Breather Element
	7 36557	1	Breather Ass'y. (Incl. 6 & 12A)
12A	36558	1	Breather Cover & Tube
	14 28277	1	Washer
	15 30589	1	Governor Rod (Incl. 14)
	16 34839A	1	Governor Lever
	17 31335	1	Governor Lever Clamp
	18 651018	1	Screw, Torx T-15, 8-32 x 19/64"
	19 35998	1	Governor Spring
	20 32600	1	Oil Seal
	30 37311	1	Crankshaft
	40 34514	1	Piston, Pin & Ring Set (Std.)
	40 34515	1	Piston, Pin & Ring Set (.010" OS)
	40 34516	1	Piston, Pin & Ring Set (.020" OS)
	41 32538B	1	Piston & Pin Ass'y. (Std.) (Incl. 43)
	41 32548B	1	Piston & Pin Ass'y. (.010" OS) (Incl. 43)
	41 32549B	1	Piston & Pin Ass'y. (.020" OS) (Incl. 43)
	42 28986	1	Ring Set (Std.)
	42 28987	1	Ring Set (.010" OS)
	42 28988	1	Ring Set (.020" OS)
	43 20381	2	Piston Pin Retaining Ring
	45 30963B	1	Connecting Rod Ass'y. (Incl. 46)
	46 32610A	2	Connecting Rod Bolt
	48 27241	2	Valve Lifter
	50 36726	1	Camshaft (RCR)
	52 29914	1	Oil Pump Ass'y.
	69 35261	1	* Mounting Flange Gasket
	70 35651E	1	Mounting Flange (Incl. 58,72 thru 83)
	72 36083	1	Oil Drain Plug
	75 26208	1	Oil Seal
	80 30574A	1	Governor Shaft
	81 30590A	1	Washer
	82 30591	1	Governor Gear Ass'y. (Incl. 81)
	83 30588A	1	Governor Spool
	86 650488	5	Screw, 1/4-20 x 1-1/4"
	89 611004	1	Flywheel Key
	90 611112	1	Flywheel
	92 650815	1	Belleville Washer
	93 650816	1	Flywheel Nut
	100 34443B	1	Solid State Ignition
	103 651007	2	Screw, Torx T-15, 10-24 x 15/16"
	110 37047	1	Ground Wire
	119 36437	1	* Cylinder Head Gasket
	120 36474	1	Cylinder Head
	125 36471	1	Exhaust Valve (Std.) (Incl. 151)
	125 36472	1	Exhaust Valve (1/32" OS) (Incl. 151)
	126 29314C	1	Intake Valve (Std.) (Incl. 151)
	126 29315C	1	Intake Valve (1/32" OS) (Incl. 151)
	130 6021A	8	Screw, 5/16-18 x 1-1/2"
	135 35395	1	Resistor Spark Plug (RJ19LM)
	150 31672	2	Valve Spring
	151 31673	2	Valve Spring Cap
	169 27234A	1	* Valve Cover Gasket
	172 32755	1	Valve Cover
	174 30200	2	Screw, 10-24 x 9/16"
	178 29752	2	Nut & Lock Washer, 1/4-28

Ref #	Part Number	Qty	Description
182	6201	2	Screw, 1/4-28 x 7/8"
184	26756	1	* Carburetor To Intake Pipe Gasket
185	36544	1	Intake Pipe
185	36544	1	Intake Pipe
186	36255	1	Governor Link
189	650839	2	Screw, 1/4-20 x 3/8"
191	36559A	1	S.E. Brake Bracket (Incl. 195)
195	610973	1	Terminal
200	37134	1	Speed Control Bracket
207	36200B	1	Throttle Link
209	30200	2	Screw & Lock Washer, 10-24 x 9/16"
223	650451	2	Screw, 1/4-20 x 1"
224	34690A	1	* Intake Pipe Gasket
238	650806	2	Screw, 10-32 x 5/8"
239	34338	1	* Air Cleaner Gasket
240	37115	1	Air Cleaner Body (Incl. 239)
245	37116	1	Air Cleaner Filter
245A	37117	1	Pre-Air Cleaner Filter
250	37118	1	Air Cleaner Cover
260	37156	1	Blower Housing
261	30200	2	Screw, 10-24 x 9/16"
262	650831	2	Screw, 1/4-20 x 1/2"
275	36473A	1	Muffler (Incl. 277)
277	650988	2	Screw, 1/4-20 x 2-5/16"
285	35000A	1	Starter Cup
287	650926	2	Screw, 8-32 x 21/64"
290	34357	1	Fuel Line
292	26460	2	Fuel Line Clamp
300	35586	1	Fuel Tank (Incl. 292 & 301)
301	36246	1	Fuel Cap
305	35577	1	Oil Fill Tube
306	36996	1	* Oil Fill Tube Gasket
307	35499	1	O'ring
309	650562	1	Screw, 10-32 x 1/2"
310	35578	1	Dipstick
313	34080	1	Spacer
370K	36695	1	Starter Decal
370A	36261	1	Lubrication Decal
370C	37199	1	Primer Decal
380	632744	1	Carburetor (Incl. 184)
390	590737	1	Rewind Starter (NOTE: This engine could have been built with 590694 starter).
400	36475B	1	* Gasket Set (Incl. items marked PK in notes) Incl. part #'s 26756 (1), 27234A (1), 33735 (1), 34338 (1), 34690A (1), 35261 (1), 36437 (1), 36832 (1), 36996 (1), 37130 (1)
420	730225	1	SAE 30 4-Cycle Engine Oil (1 Quart)

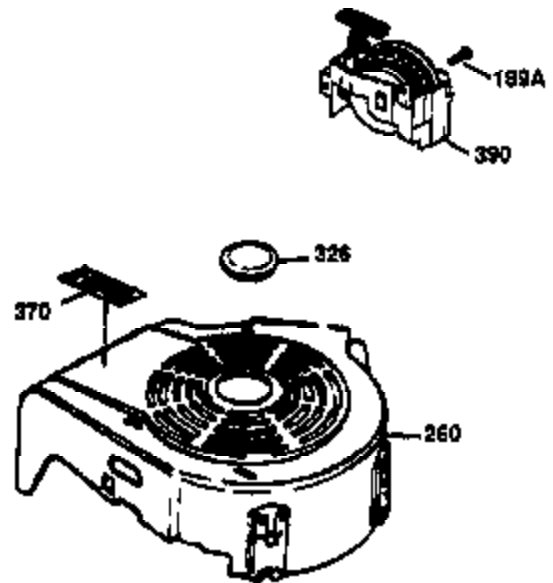

Ref #	Part Number	Qty	Description
238	650806	2	Screw, 10-32 x 5/8"
239	34338	1	* Air Cleaner Gasket
245A	37117	1	Pre-Air Cleaner Filter
245	37116	1	Air Cleaner Filter
250	37118	1	Air Cleaner Cover
260	37156	1	Blower Housing
263A	36758	1	Starter Grille
287	650926	2	Screw, 8-32 x 21/64"
300	35586	1	Fuel Tank (Incl. 292 & 301)
301	36246	1	Fuel Cap
390	590737	1	Rewind Starter (NOTE: This engine could have been built with 590694 starter).

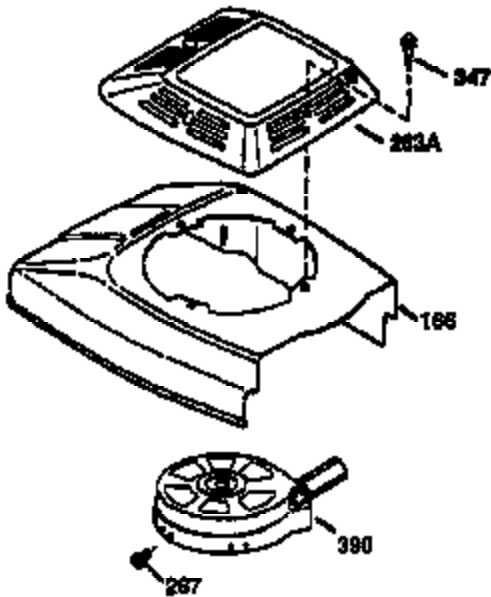
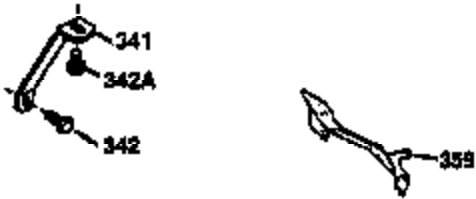

Ref #	Part Number	Qty	Description
19	35998	1	Governor Spring
69	35261	1	* Mounting Flange Gasket
70	35651E	1	Mounting Flange (Incl. 58,72 thru 83)
87	650492	1	Screw, 1/4-20 x 2-1/4"
90	611112	1	Flywheel
182	6201	2	Screw, 1/4-28 x 7/8"
185	36544	1	Intake Pipe
185	36544	1	Intake Pipe
186	36255	1	Governor Link
200	37134	1	Speed Control Bracket
209	30200	2	Screw & Lock Washer, 10-24 x 9/16"
223	650451	2	Screw, 1/4-20 x 1"
238	650806	2	Screw, 10-32 x 5/8"
245A	37117	1	Pre-Air Cleaner Filter
245	37116	1	Air Cleaner Filter
250	37118	1	Air Cleaner Cover
275A	36664	1	Spark Arrestor Muffler (Optional) (Incl. 284,284A,416,417)
275	36473A	1	Muffler (Incl. 277)
277	650988	2	Screw, 1/4-20 x 2-5/16"
284	36663	1	Muffler Deflector (Incl. 284A)(Optional)
284A	650821	1	Screw, 10-32 x 1/2" (Optional)
416	36085	1	Spark Arrestor Kit (Incl. 417)(Optional)
417	650821	1	Screw, 10-32 x 1/2" (Optional)