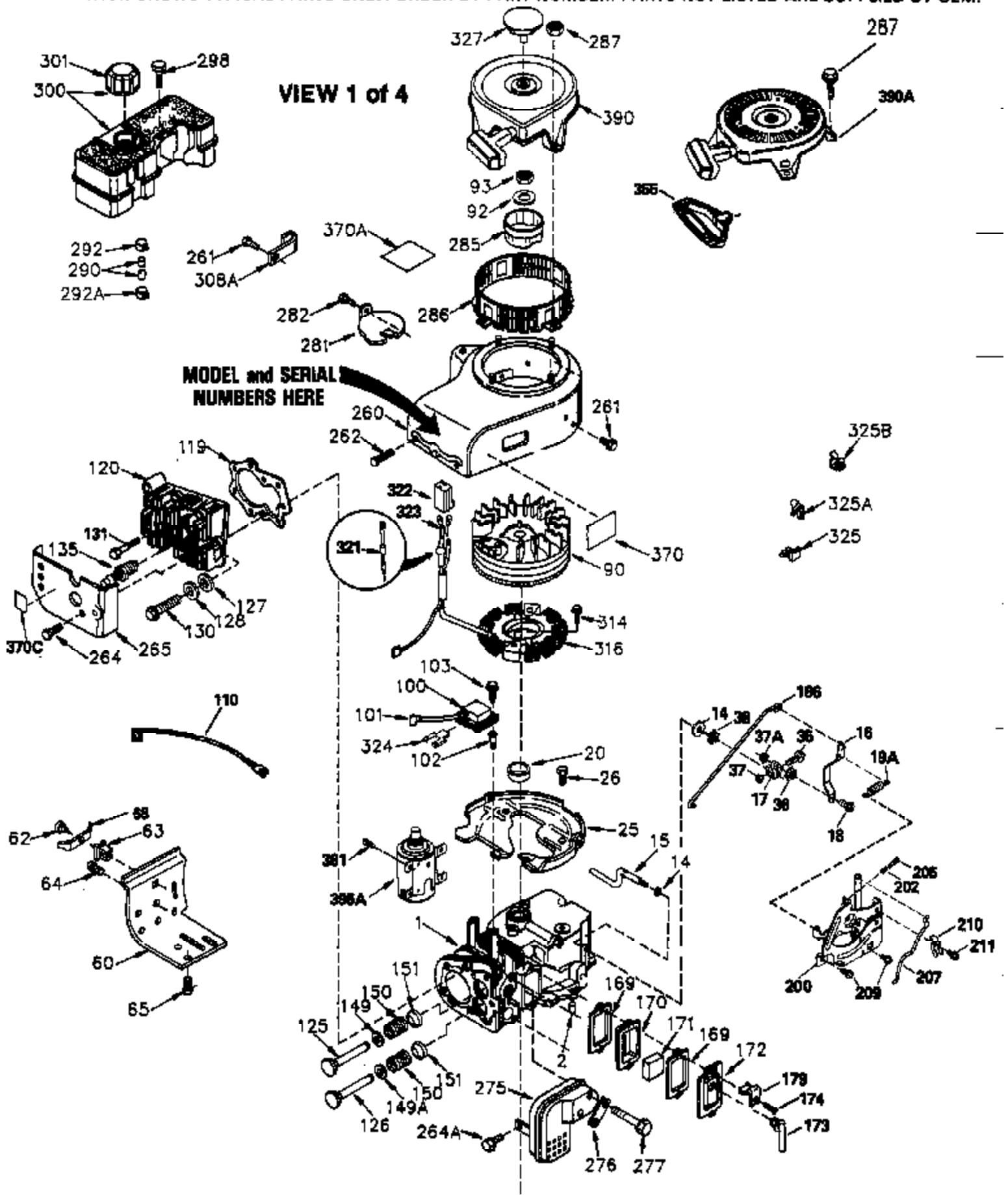

ILLUSTRATION SHOWS TYPICAL PARTS ONLY. ORDER BY PART NUMBER. PARTS NOT LISTED ARE SUPPLIED BY OEM.



Ref #	Part Number	Qty	Description
1	35383A		Cylinder (Incl. 2 & 20) (3-1/8" Bore)
2	27652		Dowel Pin
14	28277		Washer
15	35082		Governor Rod
16	32651		Governor Lever
17	31335		Governor Lever Clamp
18	650548		Screw, 8-32 x 5/16"
19A	35203		Extension Spring
20	35319		Oil Seal
25	35326		Blower Housing Baffle
26	650561		Screw, 1/4-20 x 5/8"
60	33273A		Blower Housing Extension
64	30063		Screw, Torx T-30, 1/4-20 x 1/2"
65	650128		Screw, 10-24 x 1/2"
90	611090		Flywheel
92	650880		Lock Washer
93	650881		Flywheel Nut, 5/8-18
100	35135		Solid State Ignition
101	610118		Spark Plug Cover (use as required)
102	650872		Solid State Mounting Stud
103	650814		Screw, Torx T-15, 10-24 x 1"
110	35182		Ground Wire
119	34041A		* Cylinder Head Gasket
120	34030A		Cylinder Head
125	27878A		Exhaust Valve (Std.) (Incl. 151)
125	27880A		Exhaust Valve (1/32" OS) (Incl. 151)
126	34035		Intake Valve (Std.) (Incl. 151)
126	34036		Intake Valve (1/32" OS) (Incl. 151)
127	650691		Washer (Do not use with 6021A screw)
128	650690		Belleville Washer
130	650694A		Screw, 5/16-18 x 2"
131	6021A		Screw, 5/16-18 x 1-1/2" (Do not use w /650691)
135	33636		Resistor Spark Plug (RJ17LM)
149A	35862		Valve Spring Cap (Intake)
149	27882		Valve Spring Cap (Exhaust)
150	27881		Valve Spring
151	32581		Valve Spring Keeper
169	27896A		* Valve Cover Gasket
170	28423		Breather Body
171	28424		Breather Element
172	28425		Valve Cover
173	35350		Breather Tube
174	650128		Screw, 10-24 x 1/2"
186	33860		Governor Link
200	35201		Control Bracket
202	33802		Compression Spring
205	650777		Screw, 6-32 x 21/32"
209	30200		Screw, 10-24 x 9/16"
210	27793		Conduit Clip
211	28942		Screw, 10-32 x 3/8"
238	650834		Screw, 10-32 x 1-17/32"
245A	35404		Air Cleaner Filter
260	34094B		Blower Housing (For electric starter) NOTE: Replacement hardware may differ when servicing starter assy. or blower housing. Refer to Service Bulletin 508.
261	650788		Screw, 5/16-18 x 3/4"
262	29747B		Screw, Torx T-40, 5/16-24 x 21/32"

Ref #	Part Number	Qty	Description
264A	650738		Screw, 1/4-20 x 5/8"
264	650802		Screw, 1/4-20 x 5/8"
265	33272B		Cylinder Head Cover
275	33280A		Muffler
276	31588		Locking Plate
277	650729		Screw, 5/16-18 x 3-3/16"
281	33013		Starter Bubble Cover
282	650760		Screw, 8-32 x 3/8"
285	35287A		Starter Cup
286	35446		Starter Screen
287	29752		Nut & Lock Washer, 1/4-28
298	28763		Screw, 10-32 x 35/64"
300	33583B		Fuel Tank (Incl. 292, 298 & 301)
308A	33997		Fill Tube Clip
325	29443		Wire Clip
327	35392		Starter Plug
370A	34686		Name Decal
370	34346		Instruction Decal
370C	35274		Instruction Decal
390	590633		Rewind Starter NOTE: Replacement hardware may differ when servicing starter assy. or blower housing. Refer to Service Bulletin 508. (Refer to Division 5, Section C, page 30 for breakdown or Fiche 10B, Grid G-1)
398	590685		Rewind Starter & Cup Ass'y. (This assembly replaces 590633 starter. This assembly consists of a 590671 rewind starter and a 35965A starter cup.)

ILLUSTRATION SHOWS TYPICAL PARTS ONLY. ORDER BY PART NUMBER. PARTS NOT LISTED ARE SUPPLIED BY OEM.

VIEW 2 of 4

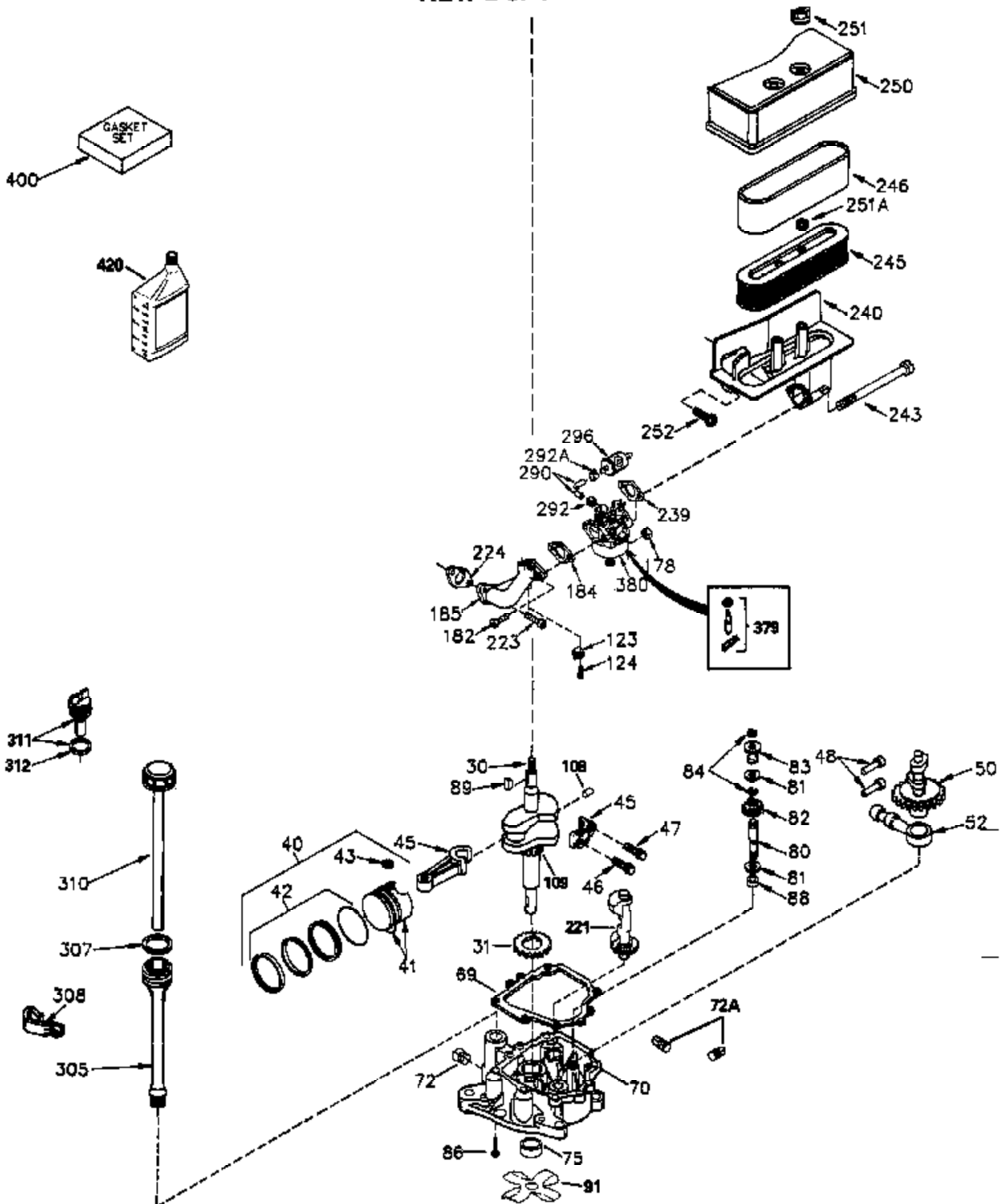

Ref #	Part Number	Qty	Description
30	35380A		Crankshaft
45	35373A		Connecting Rod (Incl. 46 & 47)
46	650908		Connecting Rod Bolt
47	650882		Connecting Rod Bolt
48	34034		Valve Lifter
50	35381		Camshaft (MCR)
52	31356		Oil Pump
69	35262		* Mounting Flange Gasket
70	35382A		Mounting Flange (Incl. 72, 75, 80 & 8 1)
72	31927		Oil Drain Plug
75	35319		Oil Seal
80	30668		Governor Shaft
81	30590A		Washer
82	35378		Governor Gear (Incl. 81)
83	30588A		Governor Spool
84	29193		Retaining Ring
86	650833		Screw, 1/4-20 x 1-3/16"
88	31707A		Spacer (Incl. 81)
89	32589		Flywheel Key
123	33261		Intake pipe Brace
124	650738		Screw, 1/4-20 x 5/8"
178	29752		Nut & Lock Washer, 1/4-28
182	30088A		Screw, 1/4-28 x 1"
184	33263		* Carburetor To Intake Pipe Gasket
185	34926		Intake Pipe
223	650378		Screw, Torx T-30, 5/16-18 x 1-1/8"
224	27915A		* Intake Pipe Gasket
238	650834		Screw, 10-32 x 1-17/32"
240	35538B		Air Cleaner Body (Incl. 239)
245A	35404		Air Cleaner Filter
245	35403		Air Cleaner Filter (Incl. 251)
250	35405		Air Cleaner Cover
251	650886		Wing Nut, 1/4-20
251A	650825		Nut & Lock Washer, 1/4-20
252	650887		Screw, 1/4-20 x 1"
305	35574		Oil Tube
307	35499		"O" Ring
308	35437		Fill Tube Clip
310	35576		Dipstick
379	631021		Inlet Needle, Seat & Clip Ass'y.
380	632238		Carburetor (Incl. 184) (Refer to Division 5, Section A, page A3-4 for breakdown or Fiche 10B, Grid E-3)
398	590685		Rewind Starter & Cup Ass'y. (This assembly replaces 590633 starter. This assembly consists of a 590671 rewind starter and a 35965A starter cup.)
400	33279G		* Gasket Set (Incl. items marked *)
420	730225		SAE 30 4-Cycle Engine Oil (Quart)

ILLUSTRATION SHOWS TYPICAL PARTS ONLY. ORDER BY PART NUMBER. PARTS NOT LISTED ARE SUPPLIED BY OEM.

VIEW 3 of 4

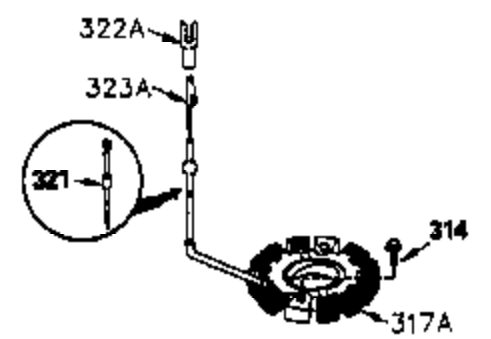
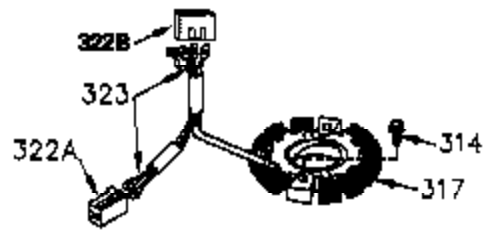
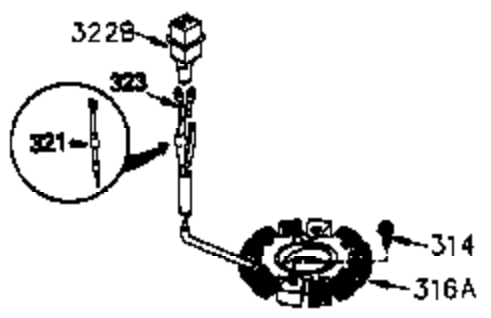
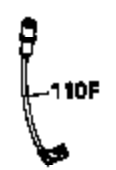
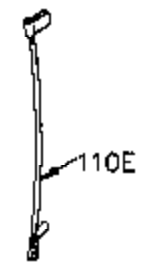
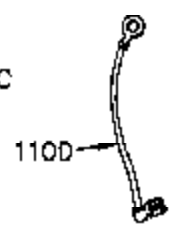
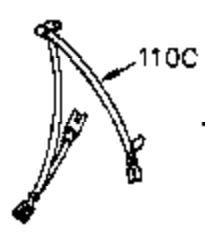
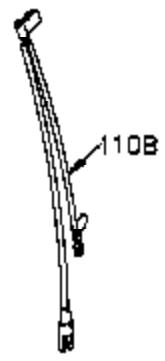
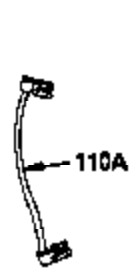
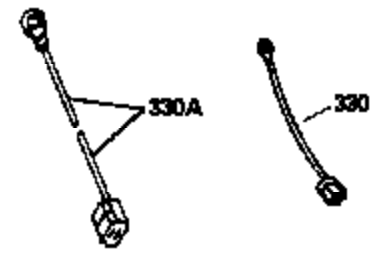
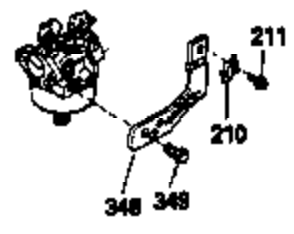
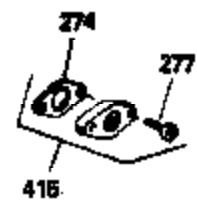
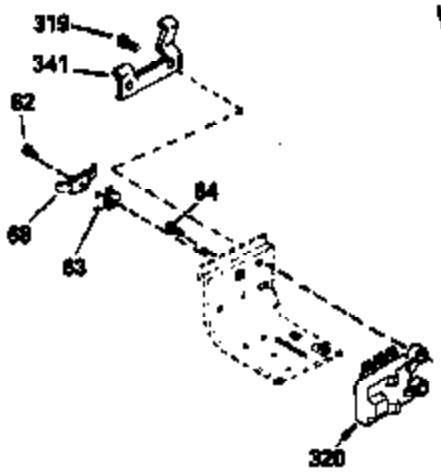

Ref #	Part Number	Qty	Description
64	30063		Screw, Torx T-30, 1/4-20 x 1/2"
210	27793		Conduit Clip
211	28942		Screw, 10-32 x 3/8"
238	650834		Screw, 10-32 x 1-17/32"
245A	35404		Air Cleaner Filter
274	35865		Exhaust Gasket (use as required)
277	650729		Screw, 5/16-18 x 3-3/16"
398	590685		Rewind Starter & Cup Ass'y. (This assembly replaces 590633 starter. This assembly consists of a 590671 rewind starter and a 35965A starter cup.)
415	730130		Exh.Adapter Kit(Incl.274 & 277)(As Re q.)

ILLUSTRATION SHOWS TYPICAL PARTS ONLY. ORDER BY PART NUMBER. PARTS NOT LISTED ARE SUPPLIED BY OEM.

STANDARD POINT IGNITION

VIEW 4 of 4

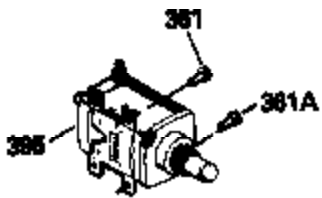
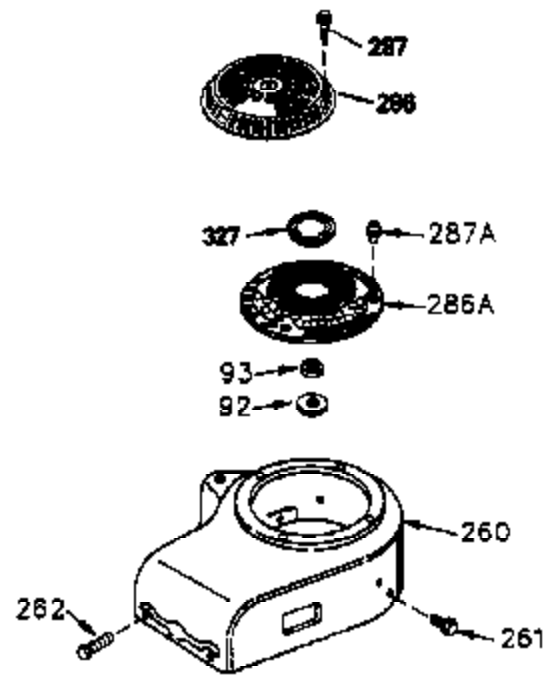
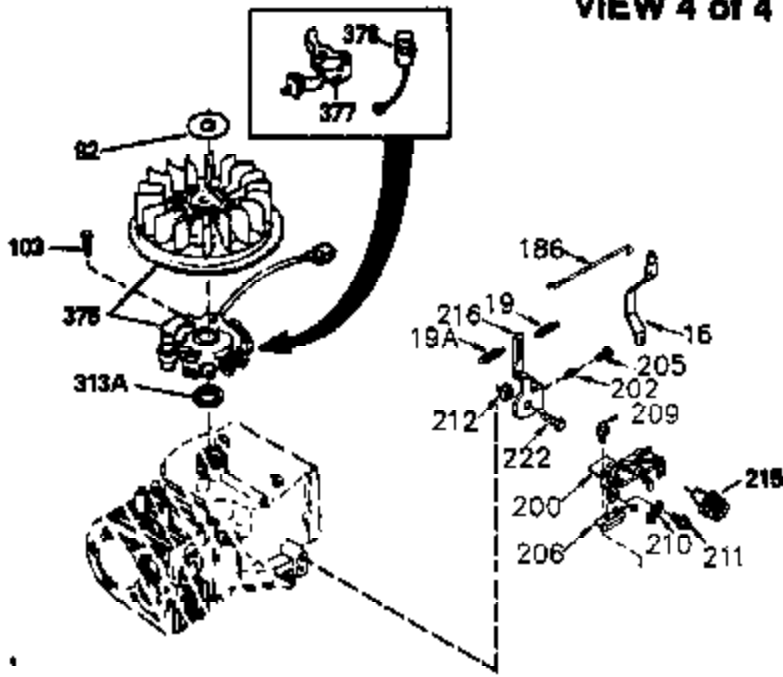

MUFFLER (QUIET)
(OPTIONAL)



OPTIONAL SPARK
ARRESTOR

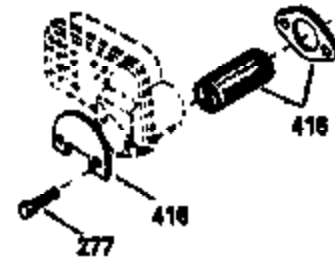

DEBRIS SCREEN KIT
(OPTIONAL)

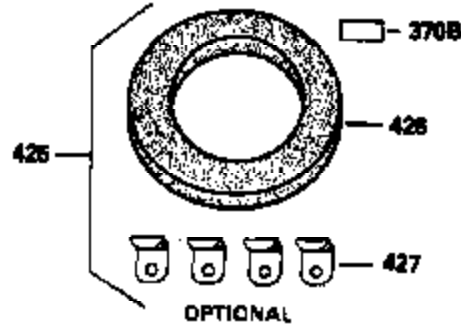
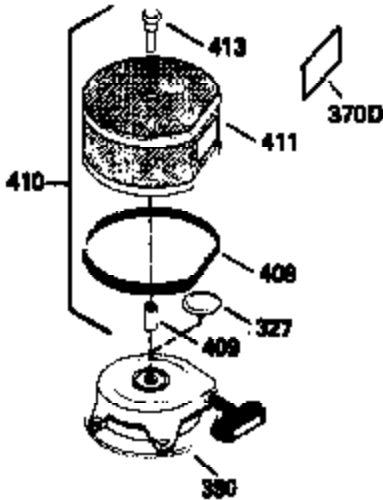

Ref #	Part Number	Qty	Description
16	32651		Governor Lever
19A	35203		Extension Spring
19	34043		Extension Spring
92	650880		Lock Washer
93	650881		Flywheel Nut, 5/8-18
103	650814		Screw, Torx T-15, 10-24 x 1"
186	33860		Governor Link
200	35201		Control Bracket
202	33802		Compression Spring
205	650777		Screw, 6-32 x 21/32"
206	610973		Terminal
209	30200		Screw, 10-24 x 9/16"
210	27793		Conduit Clip
211	28942		Screw, 10-32 x 3/8"
212	35550		Bushing
216	35202A		R.P.M. Adj.Lever (Incl.19,19A,212,222 ,239)
222	30312		Screw, 10-32 x 1/2"
238	650834		Screw, 10-32 x 1-17/32"
245A	35404		Air Cleaner Filter
260	34094B		Blower Housing (For electric starter) NOTE: Replacement hardware may differ when servicing starter assy. or blower housing. Refer to Service Bulletin 508.
261	650788		Screw, 5/16-18 x 3/4"
262	29747B		Screw, Torx T-40, 5/16-24 x 21/32"
275C	35824		Muffler (quiet) (optional)
277	650729		Screw, 5/16-18 x 3-3/16"
286	35446		Starter Screen
287A			Pop Rivet (can be purchased locally)
287	29752		Nut & Lock Washer, 1/4-28
327	35392		Starter Plug
390	590633		Rewind Starter NOTE: Replacement hardware may differ when servicing starter assy. or blower housing. Refer to Service Bulletin 508. (Refer to Division 5, Section C, page 30 for breakdown or Fiche 10B, Grid G-1)
398	590685		Rewind Starter & Cup Ass'y. (This assembly replaces 590633 starter. This assembly consists of a 590671 rewind starter and a 35965A starter cup.)
408	35570		Screen Seal (Optional)
409	35569		Spacer (Optional)
410	730573		Opt.Screen Kit (Incl.370D,408,409,411 ,413)
411	35568		Debris Screen (Optional)
413	650907		Screw, 5/16-18 x 1-5/8" (Optional)
416	34479A		Spark Arrestor Kit
425	730572		Starter Muff Kit (Incl.370,426,427)(O pt.)
426	34687		Starter Air Cleaner (Optional)
427	34869		Starter Air Cleaner Bracket (Optional)